

Pools and spas for everyone!

BWT myPOOL 2019



Table of contents

BWT myPOOL

01. FILTRATION	5-34
POOL FITTINGS	6
NOMADES NO(T)MAD UNDERWATER LIGHTS	9
PIPE FITTINGS & ACCESSORIES	10
FILTRATION UNIT	13
CARTRIDGE FILTERS	14
SAND FILTERS	16
FILTERS	18
FILTRATION ACCESSORIES	19
FILTER CARTRIDGES	20
FILTRATION PUMPS	22
ACCESSORIES FOR WOODEN POOLS	24
ELECTRICAL PANELS	25
EQUIPMENT KITS FOR POOLS	26
ALARMS	28
SHOWERS & STAINLESS STEEL LADDERS	29
STEPS	30
COUNTER-SWIM UNITS	32
ACCESSORIES	33
02. HEATING	35-38
03. WATER TREATMENT & MAINTENANCE	39-50
POOL CHEMICALS	40
WATER REGULATION	44
AUTOMATIC CLEANERS	45
POOL ROBOTS	46
MAINTENANCE ACCESSORIES	48
04. CUSTOM ORDERS	51-72
AUTOMATIC COVERS	52
BUBBLE COVERS	56
BUBBLE COVERS FOR WOODEN POOLS	58
UNDERLAY	59
WINTER AND SAFETY COVERS	60
WINTER COVERS	63
BAR COVERS	64
BAR COVERS FOR WOODEN POOLS	65
0.75 MM LINERS	66
0.75 MM LINERS FOR WOODEN POOLS	68
COMPATIBLE LINERS	70
LINER ACCESSORIES	71
05. WOODEN POOLS	73-124
WOOD A NATURAL MATERIAL	74
WINTERIZING	77
PROTECTION & SAFETY	79
TROPIC	79
POOL'N BOX	94
TROPIC JUNIOR	96
THE TROPIC RANGE	98
THE WEVA RANGE	104
THE ODYSSEA RANGE	112
WOODEN POOL LOGISTICS DATA	122
06. PRE-FAB STRUCTURES	125-138
P-PSC PARADIS BLEU POOLS	126-129
P-PSC PARADIS BLEU MINI-POOL KITS	130-131
P-PVC PARADIS BLEU POOL	132-135
PARADIS BLEU COVERS	136-137
07. SPAS	139-156
08. SPARE PARTS	157-180
09. APPENDICES	181-192

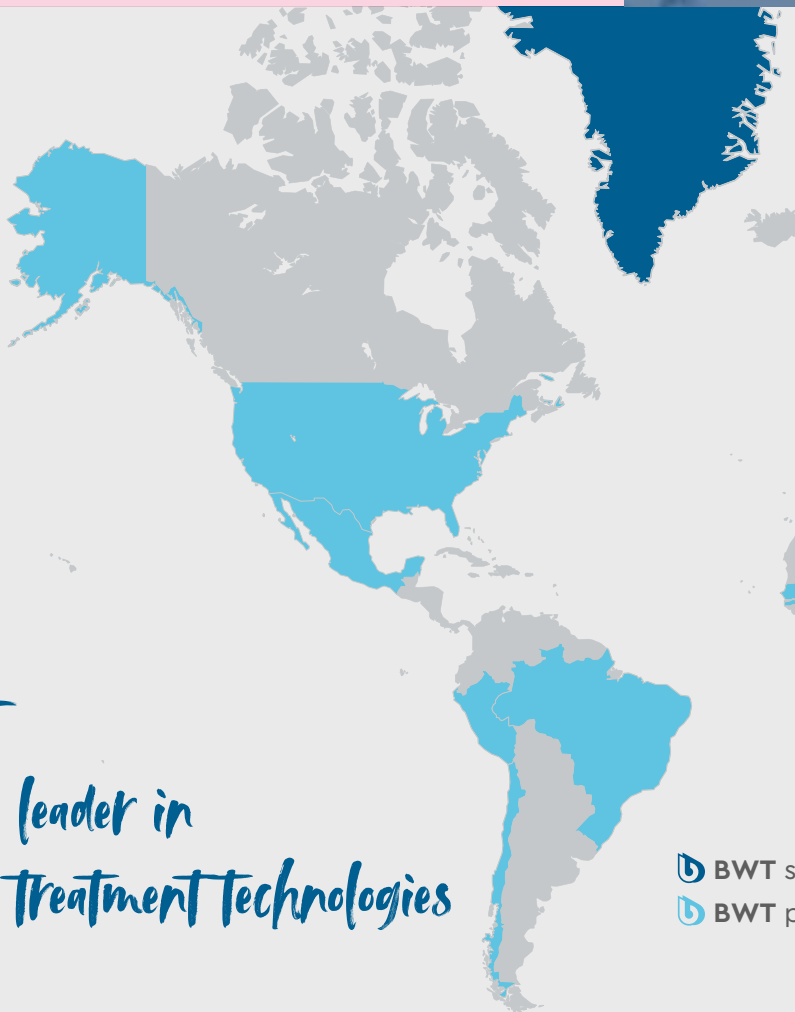

Having established ourselves as a leader on the European market, Best Water Technology is now on a mission to become an international leader in water treatment technology.

Every day, we partner clients all over the world, sharing our experience and our expertise.

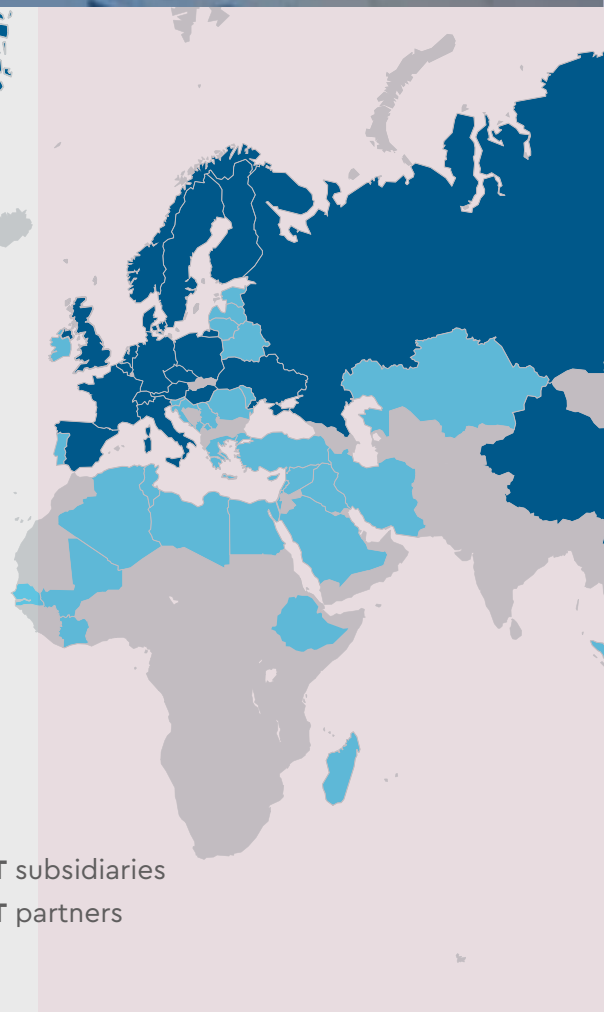

BWT
world leader in
water treatment technologies



 BWT subsidiaries
 BWT partners

America

- Brazil
- Chile
- Peru
- Mexico
- USA

Europe

- Andorra
- Croatia
- Greece
- Luxembourg
- Moldavia
- Montenegro
- Portugal
- Romania
- Serbia
- Slovenia
- Turkey

Africa

- Algeria
- Egypt
- Ethiopia
- Ivory coast
- Libya
- Madagascar
- Mali
- Morocco
- Mauritius
- Senegal
- South Africa
- Tunisia

Middle-East

- Iran
- Iraq
- Lebanon
- Palestine
- Saudi Arabia
- Syria

Asia

- China
- Hong Kong
- India
- Indonesia
- Kazakhstan
- Malaysia
- Caledonia
- Philippines
- Singapore
- South Korea
- Taiwan
- Thailand
- Vietnam

Australia - Oceania

- Australia
- New Zealand

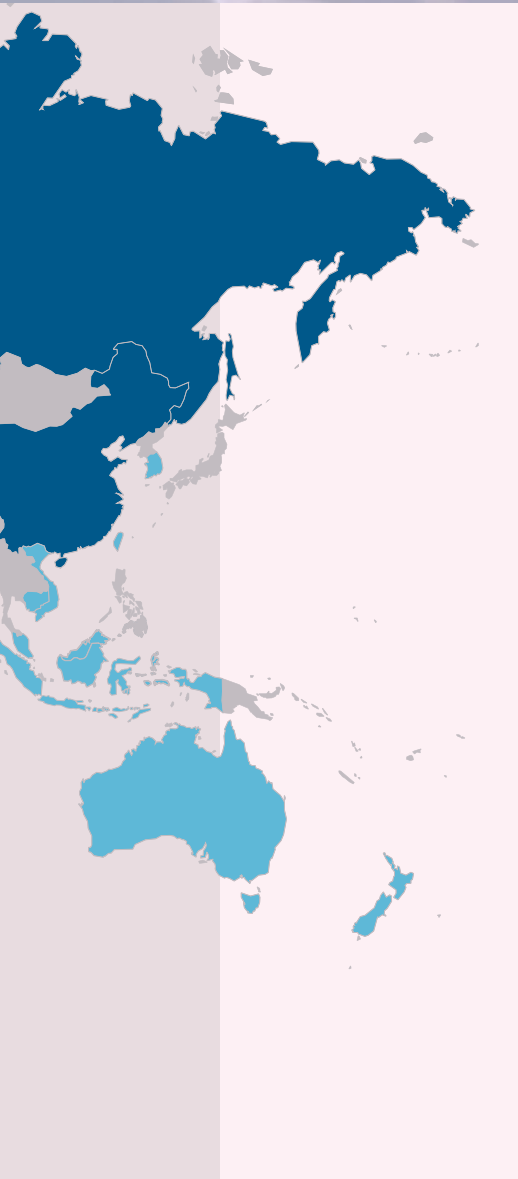

Without water there is no life, no growth, no progress. BWT is therefore dedicated to water – our lifeblood and our essential consumable – with the aim of becoming the global leader in water technology through eco-friendly, cost-effective products and processes.

The objective of BWT (Best Water Technology) is to develop the best water treatment products, equipment, technologies and services for our customers.

We even go one step further and state that water is our mission! It is our responsibility to maximise hygiene safety and well-being in our daily contact with water. BWT therefore offers a wide product portfolio comprising products and systems for filtration, softening, disinfection (UV, ozone, chlorine dioxide, etc.), limescale protection, sea water desalination, hygiene management, reverse osmosis systems, the production of purified water for the pharmaceutical industry, etc.

All BWT products and processes are highly efficient, reliable, economical and environmentally friendly.

STRONGER TOGETHER

An entrepreneurial spirit, a passion for research, the joy of innovation and success – these are the factors that have made BWT the European market leader in the diverse water treatment sector.

FOR YOU AND PLANET BLUE

Our strap-line "For You and Planet Blue" goes to the heart of our vision, which is to be a company that operates in a sustainable and responsible way – both to meet the needs of individuals and to preserve our planet Earth as a unique habitat.

Fully aware of the importance of its role, BWT uses its know-how precisely where it is needed to purify and harness our planet's limited water resources.

Basic facts about BWT:

- » **Europe's leading water technology company**
- » **Company founded:** 1990
- » **Business sectors:** private Industry, business, hotels, the public sector
- » **Team:** 3.800 employees
- » **International presence:** thousands of partners in over 80 countries worldwide
- » **Subsidiaries:** 5 production sites
- » **R&D centres:** 7 research and development centres across Europe



01

BWT myPOOL Filtration

POOL FITTINGS	6
UNDERWATER LIGHTS NOMADES NO(T)MAD	9
PLUMBING & ACCESSORIES	10
FILTRATION UNIT	13
CARTRIDGE FILTERS	14
SAND FILTERS	16
FILTERS	18
FILTRATION ACCESSORIES	19
FILTER CARTRIDGES	20
CARTRIDGES FOR FILTERS	21
FILTRATION PUMPS	22
ACCESSORIES FOR WOODEN POOLS	24
ELECTRICAL PANELS	25
KITS FOR POOLS	26
POOL EQUIPMENT KITS	27
ALARMS	28
STAINLESS STEEL LADDERS & SHOWERS	29
STEPS	30
COUNTER-SWIM UNITS	32
SWIMMING ACCESSORIES	33



BODY comprised of a skimmer body
 SHORT comprised of a body + extension or throat
 LONG comprised of a body + extension + extension or throat

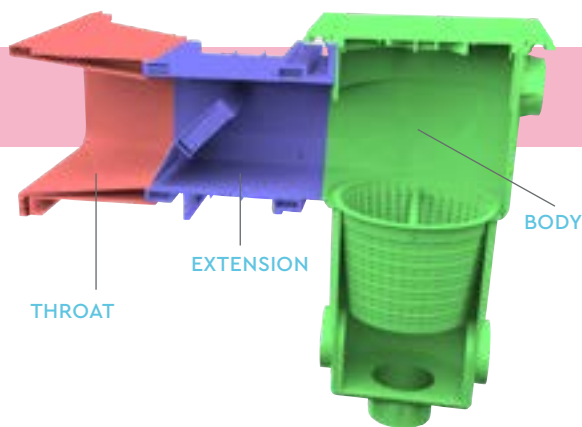

P-PM
 BWT MYPOOL
 SMALL MOUTH



P-GM
 BWT MYPOOL
 WIDE MOUTH



INFOS

All BWT MyPOOL pool fittings:
 Made of ABS
 Self-adhesive elastomer seals,
 Screws made of A4 stainless steel



Code	Description	Tropic Octo and Octo+	Weva Octo and Octo+	Weva square and rectangular	Odyssea Octo and Octo+	Odyssea rectangular
SKIMMERS						
40322119	Skimmer P-PM-Body	YES	YES	-	YES	-
40361019	Skimmer P-GM-Long	-	-	YES	-	YES
RETURN FITTINGS						
42334019	Return fittings RC38	YES	-	-	-	-
42331019	Return fittings	-	YES	YES	YES	YES
FILTRATION GROUPS						
20070001	Sand filter P-FI 400	YES	-	-	-	-
20270001	Sand filter P-FI 500	-	YES	-	-	-
261000	Sand filter P-FS 500EH	-	-	YES	YES	YES
50011000	P-AP pump 4m ³ /h	YES	-	-	-	-
50221200	P-AP pump 6m ³ /h	-	YES	-	-	-
50231200	P-AP pump 8m ³ /h	-	-	YES	YES	YES
PIPES		Ø 38mm		Ø 45mm		
ELECTRICAL PANEL		-	-	-	1 control panel & 2 UW lights (109920)	

WOODEN POOL



Code	EAN13	Description	Qty	Unit price	Qty	Unit price	Qty	Unit price
SKIMMERS								
40322119	3566835437109	Skimmer P-PM-Body, wooden panel th.45mm, white	1	44.30	9	42.09	18	39.87
40323119	3566837020651	Skimmer P-PM-Court, wooden panel th.45mm, white	1	68.50	9	65.08	18	61.65
1	40324119	Skimmer P-PM-Long, wooden panel th.45mm, white	1	78.10	8	74.20	16	70.29
	40361019	Skimmer P-GM-Long, wooden panel th.45mm, white	1	85.40	8	81.13	16	76.86
2	40261019	Skimmer P-GM pre-fix U-shaped flange, white	1	10.70	8	10.17	16	9.63
RETURN FITTINGS								
3	42333019	Ret fitting + jet, RC32 outlet, wooden panel,white	1	18.70	40	17.77	80	16.83
	42334019	Ret fitting + jet, RC38 outlet, wooden panel,white	1	18.80	40	17.86	80	16.92
	42330019	Return fitting + jet, wooden panel, white	1	11.10	40	10.55	80	9.99
UNDERWATER LIGHTS								
4	44351019	UW light PH05-W, wooden pools, white	1	76.40	20	72.58	40	68.76

MASONRY/ LINER 



Code	EAN13	Description	Qty	Unit price	Qty	Unit price	Qty	Unit price	
SKIMMERS									
1	40022019	3566837040581	Skimmer P-PM-Body, liner pools, white	1	50.00	18	47.50	36	45.00
2	40051019	3566837154752	Skimmer P-GM-Short, liner pools, white	1	71.20	8	67.64	16	64.08
3	40061019	3566837154776	Skimmer P-GM-Long, liner pools, white	1	79.60	8	75.62	16	71.64
RETURN FITTINGS									
4	42000019	3566837154738	Return fitting, liner pool, white	1	6.90	40	6.56	80	6.21
5	42030019	3566837154745	Return fitting with jet, liner pool, white	1	9.40	40	8.93	80	8.46
VACUUM POINT WITH CAP									
6	42060019	3566837154714	Vacuum point + cap, liner pools, white	1	8.90	40	8.46	80	8.01
UNDERWATER LIGHT FOR LINER POOLS									
	44006019	3566837235345	Projecteur à vis LED, pour liner, blanc	1	133.10	30	126.45	60	119.79

PANELS 



Code	EAN13	Description	Qty	Unit price	Qty	Unit price	Qty	Unit price	
SKIMMERS									
8	40262019	3566837154769	Skimmer P-GM-Long in 2 sections. panel. white	1	87.30	12	82.94	16	78.57
	40241019	3566837204808	Skimmer L-PM for Paradis Bleu panels. white	1	78.80	12	74.86	16	70.92
	40261029	3566837204792	Skimmer L-GM for Paradis Bleu panels. white	1	85.20	12	80.94	16	76.68
RETURN FITTINGS									
9	42230019	3566837154783	Return fitting + jet. panel pools. white	1	13.50	40	12.83	80	12.15
10	42331019	3566835484394	Return fitting + jet. RC38 outlet. panel. white	1	18.40	40	17.48	80	16.56
	42332019	3566837017422	Return fitting + jet. RC45 outlet. panel. white	1	18.50	40	17.58	80	16.65
	42233019	3566837235369	Return fitting + jet. for Paradis Bleu. panels. white	1	15,30	40	14,54	80	13,77
VACUUM POINT WITH CAP									
	42226019	3566837154721	Vacuum point + cap. panel pools. white	1	12.90	40	12.26	80	11.61
	42227019	3566837235376	Vaccum point + cap. Paradis bleu. white	1	14.60	40	13.87	80	13.14
UNDERWATER LIGHTS									
	44206019	3566837170868	LED UW light. P-PVC panels. white	1	133.10	30	126.45	60	119.79
	44235019	3566837235321	LED UW light. P-PSC panels. white	1	151.20	30	143.64	60	136.08



ABOVE GROUND/ FLEXIBLE WALL



	Code	EAN13	Description	Qty	Unit price	Qty	Unit price	Qty	Unit price
SKIMMERS									
1	40522019	3566831121606	Skimmer P-PM-Long, above ground pool, white	1	44.40	9	42.18	18	39.96
2	40500019	3566831021593	Floating skimmer for above-ground pools, white	1	68.50	22	65.08	45	61.65
RETURN FITTINGS									
3	42561019	3566831020589	Ret fitting+jet, RC32 outlet, flexible wall, white	1	17.60	40	16.72	80	15.84
4	42562019	3566835484400	Ret fitting+jet, RC38 outlet, flexible wall, white	1	17.40	40	16.53	80	15.66
5	48001019	3566837156947	Threaded cap 1"1/2 with o-ring, white	1	3.77	40	3.58	80	3.39

DECK BOX



	Code	EAN13	Description	Qty	Unit price	Qty	Unit price	Qty	Unit price
	45000019	3566832009620	Underwater light deck box, white	1	11.50	32	10.93	64	10.35

MAIN DRAIN



	Code	EAN13	Description	Qty	Unit price	Qty	Unit price	Qty	Unit price
	41012019	3566837154707	Main drain, liner pools, white	1	19.40	30	18.43	120	17.46

HOSE TAILS



	Code	EAN13	Description	Qty	Unit price	Qty	Unit price	Qty	Unit price
HOSE TAILS, MALE, SOLVENT, 50MM									
	48001929	3566837205003	Fixed, straight hose tail, 50 × 38 × 32, white	1	3.55	75	3.37	300	3.20
6	48002929	3566837205027	Fixed straight hose tail, 50 × 38, white	1	3.61	75	3.43	300	3.25
7	48004929	3566837205010	Fixed straight hose tail, 50 × 45, grey	1	3.65	75	3.47	300	3.29
HOSE TAILS, THREADED, 1"1/2 OR 2"									
8	48011929	3566837204990	Fixed, straight hose tail, 1"1/2 × 38 × 32, black	1	3.51	75	3.33	300	3.16
9	48012929	3566837205041	Fixed, straight hose tail, 1"1/2 × 38, black	1	3.51	75	3.33	300	3.16
10	48014929	3566837204983	Fixed, straight hose tail, 1"1/2 × 45, grey	1	3.65	75	3.47	300	3.29
	48032929	3566837205034	Fixed, straight hose tail, 1"1/2 × 45, grey	1	3.61	75	3.43	300	3.25

UNDERWATER LIGHTS NO(T)MAD



The NOTMAD underwater light can be installed absolutely anywhere to light up any space above or under water. Use it to light up your pool, your garden, even your house! This rechargeable light is very economical, no batteries required. It is very easy to use: simply push the central button to switch the light on or off or change colour. With its magnetic base, it adheres to any metal surface.

TECHNICAL DATA:

- » White light: 18 LEDs 6500k (200 lumens / 2 Watts)
- » Coloured light: 18 RGB LEDs (100 lumens / 4Watts), 7 colours + 3 automatic colour change sequences,
- » Magnetic base with metal plate,
- » Lithium-ion battery with charge indicator, service life of 300 to 400 charges, operating time of 4-5 hours with a full charge,
- » USB/DC charging cable, length 1m,
- » Protection rating IP68 at 1m,
- » Available in 3 colours: white, anthracite grey and light blue

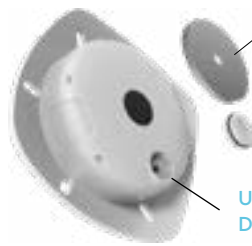

MAGNETIC BASE WITH METAL PLATE

USB PORT WITH DC/USB CABLE, 1M



Code	EAN13	Description	Qty	Unit price	Qty	Unit price	Qty	Unit price
44570000	3700450502006	No(t)mad rechargeable UW light 18 white LEDs, White	1	52.90	5	50.26	20	47.61
44570081	3700450502051	No(t)mad rechargeable UW light 18 white LEDs, L Blue	1	52.90	5	50.26	20	47.61
44570087	3700450502013	No(t)mad rechargeable UW light 18 white LEDs, Anth Grey	1	52.90	5	50.26	20	47.61
44571000	3700450502105	No(t)mad rechargeable UW light 18 RGB LEDs, White	1	52.90	5	50.26	20	47.61
44571081	3700450502150	No(t)mad rechargeable UW light 18 RGB LEDs, L Blue	1	52.90	5	50.26	20	47.61
44571087	3700450502112	No(t)mad rechargeable UW light 18 RGB LEDs, Anth Grey	1	52.90	5	50.26	20	47.61

NO(T)MAD UNDERWATER LIGHT DISPLAY STAND



TECHNICAL DATA:

- » Full colour printed display box with capacity for 6 lights,
- » 1 packaging box,
- » 1 demo No(t)mad underwater light in anthracite grey with adhesive metal plate and mains adaptor (guts pack with 18 white LEDs),
- » Dimensions and weight: 29x44x5(h)cm / 0.800Kg.

Code	EAN13	Description	Qty	Prix nand
44590000	3566837220518	No(t)mad underwater light counter display	1	31.80



LED UNDERWATER LIGHT TO BE MOUNTED ON A RETURN FITTING



TECHNICAL DATA:

- » Mounts on a 1.5" return fitting without any preparatory work and with no impact on its operation.
- » The RGB LED model features 7 colours, 3 colour change sequences. It comes with a remote control.



	Code	EAN13	Description	Qty	Unit price	Qty	Unit price	Qty	Unit price
1	44072019	3566837156954	UW light 36 LED RGB+T, jet mounted, white	1	164.30	36	156.09	150	147.87
2	44100019	3700450501498	UW light 18 LED white, jet mounted, white	1	120.10	36	114.10	150	108.09



PIPES, CIRCLIPS AND PROTECTION



	Code	EAN13	Description	Qty	Unit price	Qty	Unit price	Qty	Unit price
Ø 32MM									
1	260019	3566837204976	TORRO 25-40/12 W4 A2 circlips, set of 10	1	12.80	2	12.16	4	11.52
2	260049	3566837204945	TORRO 25/40 circlips protection, pipe D32 , set of 10	1	12.70	2	12.07	4	11.43
Ø 38MM									
3	111381	3566837066598	25m ring of tubing D38 hose tails & 2 adaptors	3	136.80	6	129.20	9	121.60
	260029	3566837204969	TORRO 35-50/12 W4 A2 circlips, set of 10	1	14.80	2	14.06	4	13.32
	260059	3566837204938	TORRO 32/50 circlips protection, pipe D38 , set of 10	1	13.70	2	13.02	4	12.33
Ø 45MM									
	111392	3566837066581	25m ring of tubing D45 hose tails & 2 adaptors	3	165.96	6	156.74	9	147.52
	260039	3566837204952	TORRO 40-60/12 W4 A2 circlips , set of 10	1	13.80	2	13.11	4	12.42
	260069	3566837204921	TORRO 40/60 circlips protection, hose D45, set of 10	1	14.70	2	13.97	4	13.23
Ø 50MM									
4	1420059	3566837157821	Flexible PVC pipe, 50mm, 25m ring, per m	300	3.84	600	3.63	900	3.42
	85006403	3566837211721	Rigid PVC pipe, 16 Bar, 50mm, 1m bar	1	3.83	10	3.64	20	3.45
	1396059	3566837220877	Circlips for PVC pipe, 50mm	1	1.22	10	1.10	30	1.04
Ø 63MM									
	85006404	3566837220921	Rigid PVC pipe, 16 Bar, 63mm, 1m bar	1	5.90	10	5.61	20	5.31
	1396069	3566837220624	Circlips for PVC pipe, 63mm	10	1.42	30	1.35	90	1.28

GLUE - STRIPPER - TEFLON



	Code	EAN13	Description	Qty	Unit price	Qty	Unit price	Qty	Unit price
5	1396109	3566837157838	PVC pressure glue. 250ml	24	6.12	48	5.78	72	5.44
6	1396309	3566837157845	Special blue glue. flexible PVC pipe. 250ml	24	6.12	48	5.78	72	5.44
7	1396709	3566837157852	PVC stripper. 500ml	24	6.03	48	5.70	72	5.36
8	1397109	3566837157869	Teflon tape. 12mm x 0.075mm x 12m	100	0.53	200	0.50	300	0.47

ELBOWS AND TEES, SOLVENT



	Code	EAN13	Description	Qty	Unit price	Qty	Unit price	Qty	Unit price
1	1342059	3566837156619	45° elbow, 50mm, F/F, solvent	80	1.05	160	0.99	240	0.94
1	85006062	3700268200415	45° elbow, 63mm, F/F, solvent	40	1.72	80	1.62	120	1.53
2	1340059	3566837156626	90° elbow, 50mm, F/F, solvent	60	0.84	120	0.79	180	0.74
2	85006065	3700268200064	90° elbow, 63mm, F/F, solvent	30	1.49	60	1.4	90	1.32
3	1348059	3566837156633	90° equal tee, 50mm, F/F, solvent	50	1.36	100	1.28	150	1.21
3	85006191	3700268200231	90° equal tee, 63mm, F/F, solvent	26	2.09	52	1.97	78	1.86

ADAPTORS - 3 PIECE UNIONS - THREADED NIPPLES - REDUCTION FITTING



	Code	EAN13	Description	Qty	Unit price	Qty	Unit price	Qty	Unit price
4	1372059	3566837156640	Adaptor socket 50mm. F/F. solvent	100	0.74	200	0.7	300	0.66
4	85006106	3700268200507	Adaptor socket 63mm. F/F. solvent	60	1.22	120	1.16	180	1.09
5	1356059	3566837156657	3 piece adaptor union. 50mm. F/F. solvent	60	2.71	120	2.56	180	2.41
5	85006157	3700268200323	3 piece adaptor union. 63mm. F/F. solvent	36	3.98	72	3.76	108	3.54
6	1358059	3566837156664	3 piece adaptor. 50x1"1/2. F solvent x M threaded	60	2.91	120	2.75	180	2.58
6	85006153	3700268201801	3 piece adaptor. 63x1"1/2. F solvent x M threaded	36	4.77	72	4.51	108	4.24
7	1364059	3566837157654	Adaptor nipples. 50x1"1/2. F solvent x M threaded	120	0.84	240	0.79	360	0.74
8	1364069	3566837157708	Adaptor nipples 63/50x2". F solvent x M threaded	80	1.05	160	0.99	240	0.94
	85006172	3700268201290	Reduction fitting M/F. 63 x 50mm	50	0.73	100	0.69	150	0.65

1/4 TURN VALVES



EASYFIT VALVE TECHNICAL DATA:

The EASYFIT features a multi-function hand grip that can be used to tighten and loosen the barrel unions, without any need for additional tools (wrench for example). This extends the service life and facilitates maintenance (assembly, dismantling, etc.).

	Code	EAN13	Description	Qty	Unit price	Qty	Unit price	Qty	Unit price
9	1410054	3566835472551	1/4 turn double union valve, 1"1/2M x 50F	15	14.94	30	14.11	45	13.28
10	1410057	3566835527718	1/4 turn double union valve, 1"1/2M x RC45	15	16.11	30	15.22	45	14.32
11	1410009	3566837157807	1/4 turn valve, 50mm, double union, F/F, solvent	16	9.90	32	9.35	48	8.80
12	85006505	3566837220938	EASYFIT double union valve, female, 50mm	15	18.99	30	17.94	45	16.88
12	85006506	3566837220945	EASYFIT double union valve, female, 63mm	16	27.54	32	26.01	48	24.48



© Anamig



SOLIFLOW® - FILTRATION UNIT

TECHNICAL DATA:

- » Compact filtration unit made of anti-UV treated ABS,
- » Filtration finesse: 25 µm with a filter bag or 15µm with a cartridge (optional),
- » Throughput: 1.1 (m³/h)/m² with a cartridge and 10.2 (m³/h)/m² with a filter bag,
- » Total filtration surface area: 1.08m² (with a filter bag),
- » Filtration flow rate with return fittings: 11m³/h,
- » Pump delivered assembled with a remote installed electrical panel that features a timer, motor protection and a 30mA differential circuit breaker,
- » Includes one transformer, for connection of an underwater light,
- » Delivered with 6 filter bags,
- » Reduced footprint: 400 × 800 × 1000mm,
- » Weight: 22kg

DIMENSIONS DU CARTON (LXLXH):
81X41X108CM



SOLIFLOW ADVANTAGES

Complete filtration system integrated into a compact unit 400 × 800mm,
Unrestricted positioning of the return fitting(s) and the underwater light,
There are no pipes or valves inside Soliflow: no risks of leaks,
Self-priming 400W pump, very high yield, not compatible with a Redox potential greater than 750mV,
Remote installed electrical panel,
Can be installed with 1 or 2 return fittings,
Disposable filter bag,
Very little maintenance and winterizing,
Discreet and visually pleasing,
Runs very quietly.

Code	EAN13	Description	Qty	Unit price	Qty	Unit price	Qty	Unit price
8410000	3566835447481	Soliflow with 11m³/h 1ph pump and electrical panel	1	1,315.00	3	1,249.25	9	1,183.50
OPTIONS								
8465200	3566835464105	Front panel trim - White	1	8.60	3	8.17	9	7.74
8465281	3566835512165	Front panel trim - Light blue	1	12.60	3	11.97	9	11.34
8465282	3566835512172	Front panel trim - Dark blue	1	12.60	3	11.97	9	11.34
1 8465285	3566835512196	Front panel trim - Green	1	12.60	3	11.97	9	11.34
8465286	3566837205447	Front panel trim - Beige	1	12.60	3	11.97	9	11.34
8465288	3566835512202	Front panel trim - Grey	1	12.60	3	11.97	9	11.34
8465289	3566835512219	Front panel trim - Black	1	12.60	3	11.97	9	11.34
8463401	3566835474326	Soliflow filter cartridge and housing	1	211.00	4	200.45	8	189.90
CONSOMMABLES								
8463100	3566835447504	Set of 5 spare filter bags	1	45.30	5	43.04	15	40.77
8493410	3566835474333	Soliflow filter cartridge	1	63.80	3	60.61	9	57.42



The French standard NFC15-100 requires the installation of a 30mA circuit breaker.



As the Soliflow pump is submerged in water, it may be subject to corrosion, notably if the Redox potential of the water is greater than 750mV.
If the pool is treated with a salt water electrolyser, the production of Sodium Hypochlorite must be controlled using a Redox sensor



REMOTE INSTALLED ELECTRICAL PANEL



WELTICO DESIGN SKIMFILTERS

TECHNICAL DATA:

- » Filtering skimmers for pools between 25m³ and 80m³.
- » UV stable ABS, a material perfectly suited to the pool environment.
- » The long narrow skimmer mouth tucks under the coping so that the water level can be raised to sit just 60mm below the coping (Skimfilter A800).



A 800

OPERATION OF THE DESIGN AND ELEGANCE SKIMFILTERS

- » Water enters through the skimmer mouth. The swinging flap retains debris. Water then flows through a basket that traps any large debris (needles, leaves, etc.)
- » The water is then filtered through a pleated cartridge, with a retention rating of 15µ.
- » The clean water is taken in by the pump and returned to the pool.



Skimfilter	Pool volume	Pump max recommended flow rate
C6	up to 70m ³	20m ³ /h
C7	up to 80m ³	24m ³ /h

Code	EAN13	Description	Qty	Unit price	Qty	Unit price	Qty	Unit price
85003005	3760094187571	Skimfilter A400 Design C6 concrete liner. 20m ³ /h	1	507.00	2	481.65	6	456.30
85003006	3760094187786	Skimfilter A400 Design C6 panel liner. 20m ³ /h	1	539.00	2	512.05	6	485.10
85003022	3760094183825	Skimfilter A800 Design C6 concrete liner. 20m ³ /h	1	594.00	2	564.30	6	534.60
85003023	3760094183788	Skimfilter A800 Design C6 panel liner. 20m ³ /h	1	621.00	2	589.95	6	558.90
85003025	3760094183764	Skimfilter A800 Design C7 concrete liner. 24m ³ /h	1	600.00	2	570.00	6	540.00
85003026	3760094183757	Skimfilter A800 Design C7 panel liner. 24m ³ /h	1	654.00	2	621.30	6	588.60

WELTICO ELEGANCE SKIMFILTERS

TECHNICAL DATA:

- » Filtering skimmers for pools between 25m³ and 80m³.
- » UV stable ABS, a material perfectly suited to the pool environment.
- » Filter basket fitted with a disposable WELBAG pre-filter.



Code	EAN13	Description	Qty	Unit price	Qty	Unit price	Qty	Unit price
85003013	3760094182576	Skimfilter A400 Elegance C6 concrete liner. 20m ³ /h	1	507.00	2	481.65	6	456.30
85003014	3760094182590	Skimfilter A400 Elegance C6 panel liner. 20m ³ /h	1	539.00	2	512.05	6	485.10
85003016	3760094180145	Skimfilter A400 Elegance C7 concrete liner. 24m ³ /h	1	543.00	2	515.85	6	488.70
85003017	3760094182606	Skimfilter A400 Elegance C7 panel liner. 24m ³ /h	1	574.00	2	545.30	6	516.60

WELFILTRE CARTRIDGE FILTERS 

TECHNICAL DATA:

- » Economical filter with a small footprint, ideal for renovation projects and above-ground pools.
- » Cartridge accessed through the filter lid which features a 38mm union.
- » Water leaves through an outlet at the bottom of the filter, the outlet port has a 38mm hose tail (32mm as an option).

Welfilter	Pool volume	Pump max recommended flow rate
C3	20 to 35m ³	11m ³ /h
C5	35 to 50m ³	13m ³ /h
C6	35 to 65m ³	17m ³ /h
C7	35 to 80m ³	20m ³ /h

CARTRIDGE FILTER FOR POOLS FROM 25M³ TO 80M³:

- » Excellent retention rating (15microns)
- » Large capacity cartridge
- » Ecological, thanks to their simple cleaning method that requires very little water
- » Compact design
- » 50mm solvent inlet/ outlet ports
- » Delivered with a 38mm hose tail, solvent
- » Ideal for above ground pools



Filtration cartridge



Drain plug



Code	EAN13	Description	Qty	Unit price	Qty	Unit price	Qty	Unit price
85001712	3760094187168	Welfiltre C3 cartridge filter	1	226.00	2	214.70	6	203.40
85001713	3760094187175	Welfiltre C5 cartridge filter	1	268.00	2	254.60	6	241.20
85001714	3760094187182	Welfiltre C6 cartridge filter	1	321.00	2	304.95	6	288.90
85001715	3760094187199	Welfiltre C7 cartridge filter	1	373.00	2	354.35	6	335.70

WEAR PARTS

796350	3760094185515	SkimFiltre C2 cartridge. non-separable	2	85.50	4	80.75	12	76.00
796400	3760094185522	SkimFiltre C3 cartridge. non-separable	2	92.43	4	87.30	12	82.16
796450	3760094185539	SkimFiltre C5 cartridge. non-separable	2	95.49	4	90.19	12	84.88
796500	3760094185546	SkimFiltre C6 cartridge. non-separable	2	104.04	4	98.26	12	92.48
796550	3760094185553	SkimFiltre C7 cartridge. non-separable	2	127.89	4	120.79	12	113.68

SÉRIE FC CARTRIDGE FILTERS

TECHNICAL DATA:

- » ABS tank.
- » Rapid, easy lid opening and closing system.
- » Threaded hydraulic connections, 1" 1/2, delivered without unions.
- » Automatic air vent plus manual vent integrated into the lid.
- » Pressure gauge, air bleed and drain cap.

Flow rate (m ³ /h)	FC 25	FC 50	FC 70
	6.8	13.6	19.1

(mm)	FC 25	FC 50	FC 70
A	460	708	809
B	120	120	120
C	70	70	70
D	266	266	266
E	276	276	276

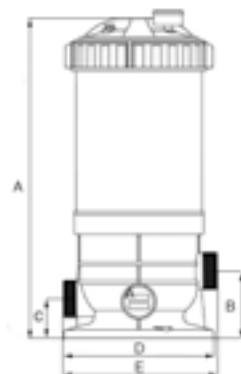

1



2



3



	Code	EAN13	Description	Ø Union	Qty	Unit price	Qty	Unit price	Qty	Unit price
1	9660000	3566837060596	FC25 cartridge filter	1.5"	2	91.20	2	86.64	4	82.08
2	9660200	3566837060602	FC50 cartridge filter	1.5"	2	124.70	2	118.47	4	112.23
3	9660400	3566837060619	FC70 cartridge filter	1.5"	2	143.80	2	136.61	4	129.42

WEAR PARTS

	9660050	3566837090135	FC25 filter cartridge	-	1	22.40	2	21.28	4	20.16
	9660250	3566837090142	FC50 filter cartridge	-	1	32.40	2	30.78	4	29.16
	9660450	3566837090159	FC70 filter cartridge	-	1	36.70	2	32.97	4	31.23

SAND FILTERS



P-FI SAND FILTERS

TECHNICAL DATA:

- » Light grey, ABS injection moulded sand filter,
- » 6-way valve integrated into the upper section of the filter, fitted with 3 solvent inlets/outlets, Ø 50mm,
- » The P-FI sand filter is delivered with the following unions (not assembled):
2 hose tails, Ø 38mm/ male, solvent, Ø 50mm,
2 hose tails, Ø 45mm/ male, solvent, Ø 50mm,
1 translucent union, Ø 38mm/ male, solvent, Ø 50mm, for connection to the drain,
1 tube of PVC union glue,
- » Collector plate covering the entire surface area of the filter simplifies assembly (no individual laterals),
- » The filter lid may be lifted off completely for easy access to the filter media,
- » The filter comes with a black ABS base as standard,
- » Maximum operating pressure (according to the French standard NF EN 16713-1): 1.1 bar.



These filters are delivered without the filter media (use sand with a grain size between 0.6 to 1.25).

	Code	EAN13	Description	Qty	Unit price	Qty	Unit price	Qty	Unit price
1	20070001	3566835523970	P-FI 400 sand filter with 1"1/2 valve. grey	1	134.80	12	128.06	24	121.32
	20170001	3566835524014	P-FI 400EH sand filter with 1"1/2 valve. grey	1	145.50	12	138.23	24	130.95
	20270001	3566835523987	P-FI 500 sand filter with 1"1/2 valve. grey	1	172.90	12	164.26	24	155.61

P-GFI FILTRATION GROUPS

TECHNICAL DATA:

- » Light grey, ABS injection moulded sand filter,
- » Self-priming pump, with prefilter
- » Pump/ filter connection kit, including 2 hose tails, Ø 38, tube of glue and 2 clamps,
- » 6-way valve integrated into the upper section of the filter, fitted with 3 solvent inlets/outlets, Ø 50mm,
- » Collector plate covering the entire surface area of the filter simplifies assembly (no individual laterals),
- » The filter lid may be lifted off completely for easy access to the filter media,
- » The filter comes with a black ABS base as standard,
- » Maximum operating pressure (according to the French standard NF EN 16713-1): 1.1 bar.



These filters are delivered without the filter media (use sand with a grain size between 0.6 to 1.25).

	Code	EAN13	Description	Qty	Unit price	Qty	Unit price	Qty	Unit price
2	20575110	3566835525370	P-GFI 400 filtration group. 4m ³ /h. grey	1	308.00	12	292.60	24	277.20
	20575210	3566837022679	P-GFI 400 filtration group. 6m ³ /h. grey	1	328.00	12	311.60	24	295.20
	20675210	3566837022662	P-GFI 400EH filtration group. 6m ³ /h. grey	1	339.00	12	322.05	24	305.10
	20775410	3566837022655	P-GFI 500 filtration group. 8m ³ /h. grey	1	376.00	12	357.20	24	338.40
	20775610	3566835528081	P-GFI 500 filtration group. 11m ³ /h. grey	1	398.00	12	378.10	24	358.20

	P-FI 400	P-FI 400EH	P-FI 500	P-FI 400/4	P-FI 400/6	P-FI 400EH/6	P-FI 500/8	P-FI 500/11
QUANTITY OF SAND RECOMMENDED PER MODEL (KG)	20	25	50	20	20	20	50	50
RECOMMENDED POOL VOLUME (M ³)	24	24	32	24	24	24	32	32
PACKAGING DIMENSIONS (LxWxH, CM)	43x43x43	43x43x53	53x53x57	51x43x65	51x43x65	51x43x75	53x53x78	53x53x78
PACK WEIGHT (KG)	7	8	11	14	15	16	23	24



P-FS SAND FILTERS

TECHNICAL DATA:

- » High density polyethylene tank,
- » 6-way valve with 1 pressure gauge and 1 clamp,
- » Maximum operating pressure (according to the French standard NF EN 16713-1): 1.2 bar.

These filters are not delivered with the filter media (use sand with a grain size between 0.6 to 1.25).



Code	EAN13	Description	Qty	Unit price	Qty	Unit price	Qty	Unit price
260000	3566831003582	P-FS 400 sand filter with 1"1/2 valve, blue	1	141.80	12	134.71	24	127.62
260500	3566831003629	P-FS 400EH sand filter with 1"1/2 valve, grey	1	152.30	12	144.69	24	137.07
1 261000	3566831003674	P-FS 500EH sand filter with 1"1/2 valve, grey	1	192.10	12	182.50	24	172.89
263000	3566831004107	P-FS 610 sand filter with 1"1/2 valve, grey	1	210.00	12	199.50	24	189.00

GROUPES DE FILTRATION P-GFS

GROUP COMPONENTS:

- » Filter without sand (sand is sold separately in 25Kg bags),
- » 6-way valve with configurable pressure gauge and clamp,
- » Self-priming pump, with prefilter
- » Pump/ filter connection kit,
- » Fibreglass reinforced polypropylene base,
- » Flow rates quoted are indicative, the flow rates will vary depending on the load loss across the installation and the pump's performance curve.



Code	EAN13	Description	Qty	Unit price	Qty	Unit price	Qty	Unit price
111000	3566835445777	P-GFS 400 filtration group. 6m ³ /h. blue	1	353.00	12	335.35	24	317.70
111500	3566835483694	P-GFS 400-EH filtration group. 6m ³ /h. grey	1	370.00	12	351.50	24	333.00
2 111100	3566835445784	P-GFS 500-EH filtration group. 8m ³ /h. grey	1	439.00	12	417.05	24	395.10
113000	3566837058180	P-GFS 610 filtration group. 11m ³ /h. grey	1	472.00	12	448.40	24	424.80

	P-FS 400	P-FS 400EH	P-FS 500	P-FS 610	P-GFS 400	P-GFS 400EH	P-GFS 500	P-GFS 610
QUANTITY OF SAND RECOMMENDED PER MODEL (KG)	20	25	75	100	20	25	75	100
RECOMMENDED POOL VOLUME (M ³)	24	24	32	43	24	24	32	43
PACKAGING DIMENSIONS (LXWXH, CM)	41x41x71	44x41x79	56x56x96	61x61x89	73x43x52	80x60x66	56x56x96	61x61x89
PACK WEIGHT (KG)	9	10	16	16	20	19	27	27



P-FSE SAND FILTERS



TECHNICAL DATA:

- » Bobbin wound fibreglass reinforced high density polyethylene tank,
- » Fibreglass loaded polypropylene base,
- » Transparent ABS lid, with air bleed valve and collar clamp,
- » 6-way side valve, pre-mounted with bulkhead fittings and a pressure gauge,
- » P-FSE Side filters internal pipework diameter Ø 63mm,
- » Max operating pressure (according to NF EN 16782-1): 1.6 bar.
- » These filters are delivered without the filter media (use sand with a grain size between 0.6 to 1.25 and gravel between 2.0 and 4.0).



	Code	EAN13	Description	Qty	Unit price	Qty	Unit price	Qty	Unit price
1	120000	3566835421443	P-FSE 500-EH sand filter	1	372.00	4	353.40	12	334.80
	125000	3566835421450	P-FSE 610 A sand filter	1	376.00	4	357.20	12	338.40
	125005	3566837156374	P-FSE 610 B sand filter	1	405.00	4	384.75	12	364.50

Description	Max. flow rate m ³ /h	Filter Ømm H mm		Filter medium gravel/ sand	Valve	Recommended pool volume (m ³)	Packaging dimensions (LxWxH, cm)	Package weight (Kg)
P-FSE 500-EH sand filter	10	500	835	75 (of which 25kg is gravel)	1"1/2	32	56x56x94	22
P-FSE 610 A sand filter	14	610	765	100 (of which 25kg is gravel)	1"1/2	43	62x62x91	23
P-FSE 610 B sand filter	14	610	765	100 (of which 25kg is gravel)	2"	43	62x62x91	23



EVERBAG PRE-FILTER

TECHNICAL DATA:

- » The Everbag pre-filter is made up of a rigid ABS ring with a fastener, handle and a filter bag made of rigid woven fabric with retention rating of 500-microns.
- » This pre-filter traps large debris (leaves, grass, insects, etc.) drawn in by the skimmer, preventing clogging of the filter and protecting the pump.
- » It is cleaned simply by turning it inside out and gently brushing the material.
- » EVERBAG pre-filters are available in 5 sizes (P2 to P7). P2 pre-filters are compatible with JUMBOSKIM skimmers, pre-filters P3 to P7 fit TWINFILTERS and SKIMFILTERS.



Code	EAN13	Description	Qty	Unit price	Qty	Unit price	Qty	Unit price
PRE-FILTER EVERBAG								
85002932	3760094188103	Pre-filter Everbag Weltico - P2	10	30.87	20	29.16	30	27.44
85002933	3760094188110	Pre-filter Everbag Weltico - P3	10	32.94	20	31.11	30	29.28
85002934	3760094188134	Pre-filter Everbag Weltico - P5	10	36.81	20	34.77	30	32.72
85002935	3760094188707	Pre-filter Everbag Weltico - P6	10	38.52	20	36.38	30	34.24
85002936	3760094188738	Pre-filter Everbag Weltico - P7	10	40.14	20	37.91	30	35.68

SKIMMER BASKET DISPOSABLE PRE-FILTER, WELBAG



TECHNICAL DATA:

- » Reduces maintenance and limits clogging of cartridge and sand filters by trapping debris suspended in the pool water (leaves, grass, insects, etc.)
- » Generously sized to adapt to all skimmer filters and skimmer baskets.
- » Excellent resistance to chlorinated products.
- » Sold in packs of 10.

Code	EAN13	Description	Qty	Unit price	Qty	Unit price	Qty	Unit price
85003501	3760094182668	Welbag disposable prefilter for skimmer basket	10	9.54	20	9.01	30	8.48

FILTRATION SAND

Code	EAN13	Description	Qty	Unit price	Qty	Unit price	Qty	Unit price
241109	3566837156602	Sand 0.6/1.25 - 48 25Kg bags	1	363.00	10	344.85	19	326.70
81519	3566837157142	Sand freight charges per pallet	1	POA	10	POA	19	POA

Transport costs are quoted net of any discount



IN-GROUND PLANT HOUSING

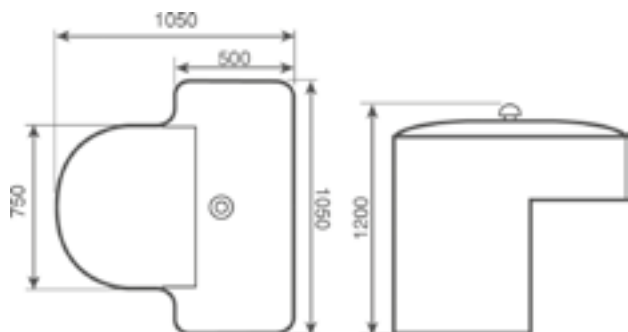

- » Compatible with all P-FI and P-FS filters except the P-FS 500EH filter



Code	EAN13	Description	Qty	Unit price	Qty	Unit price	Qty	Unit price
758000	3566831019033	P.M.T. plant housing	1	709.00	2	673.55	4	638.10

FILTER CARTRIDGES

WELTICO SKIMFILTER CARTRIDGES

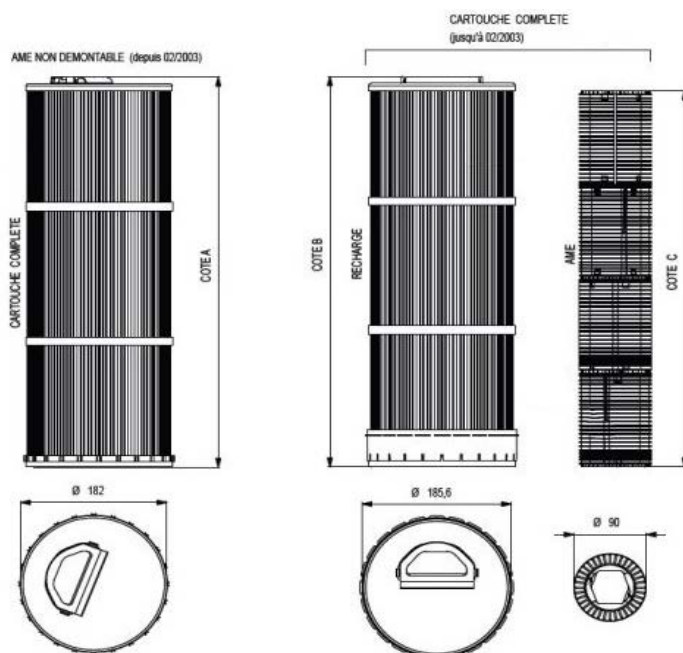

TECHNICAL DATA:

- » WELTICO cartridges are available in 5 sizes (C2 to C7) with a filtration surface area between 2.5 and 7.6m². The cartridges have a retention rating of 15microns.
- » Use of a flocculent can improve filtration finesse.
- » The cartridges are fitted with an anti-clogging device to prevent the folds from adhering together.
- » The EVERBAG pre-filter is perfect partner for the cartridge for deep cleans at the beginning of the season.
- » The cartridges should be cleaned at least once a month by soaking them in a solution of WELCLEAN and rinsing them with water. The filter cartridges have a service life of 1 to 3 seasons, depending on pool use.
- » Good water treatment is mandatory for the filter to work properly.

Code	EAN13	Description	PAGES
796350	3760094185515	Cartridge for Skimfilter C2 non-separable	15
796400	3760094185522	Cartridge for Skimfilter C3 non-separable	15
796450	3760094185539	Cartridge for Skimfilter C5 non-separable	15
796500	3760094185546	Cartridge for Skimfilter C6 non-separable	15
796550	3760094185553	Cartridge for Skimfilter C7 non-separable	15

TYPE	DIM A	DIM B	DIM C
CARTRIDGE FOR C2 FILTER	270	269	250
CARTRIDGE FOR C3 FILTER	395	394	375
CARTRIDGE FOR C5 FILTER	520	519	500
CARTRIDGE FOR C6 FILTER	645	644	625

CARTRIDGES FOR FC SERIES FILTERS

Code	EAN13	Description	PAGES
9660050	3566837090135	Cartridge for FC25 filters	15
9660250	3566837090142	Cartridge for FC50 filters	15
9660450	3566837090159	Cartridge for FC70 filters	15

	NUMBER OF FOLDS	INNER DIAMETER (MM)	OUTER DIAMETER (MM)	HEIGHT (CM)
CARTRIDGE FOR FC25 FILTERS	111	176	76	24.92
CARTRIDGE FOR FC50 FILTERS	110	178	76	49.85
CARTRIDGE FOR FC70 FILTERS	120	178	76	64.77

FILTRATION CARTRIDGES



CODE	OVERALL HEIGHT	OUTER Ø	INNNER Ø
9704250	200	106	50
9704200	305	145	45
1014050	-	-	-
27931650	254	92	24
27900320	180	125	screwed 1.5"
31090207	230	145	screwed 1.5"
31090208	230	145	50
8493410	360	250	145

	Code	EAN13	Description	Qty	Unit price	Qty	Unit price	Qty	Unit price
1	9704250	3566837130916	Bottom filtration cartridge, compatible Intex 8*	12	7.56	24	7.14	48	6.72
	9704200	3566837130909	Upper filtration cartridge, compatible Intex 12*	12	24.75	24	23.38	48	22
2	1014050	3566837120979	Star Vac II NG compatible filtration cartridge	1	40.10	4	38.10	12	36.09
	27931650	3566837162061	Pistoche pool filter cartridge	Page 83					
	27900320	3566837206369	Urban pool filter cartridge	Page 89					
	31090207	3566837157753	Skimmer filtration cartridge SF-2C for spas, set of 2	Page 156					
	31090208	3566837157760	Skimmer filtration cartridge SF-1C for spas	Page 156					
	8493410	3566835474333	Soliflow filter cartridge	Page 166					

FILTERING CARTRIDGE CLEANER

At last, a cleaner for filtering cartridges that takes the pain out of cleaning the filter. Easy to use, it mounts simply on a garden hose. A button switches the cleaner on. Ergonomic, the filter cleaner looks like a shower head with an integrated comb. The comb opens and separates 8 cartridge folds while the nozzles spray jets of pressurised water. Very practical, no splashing.

TECHNICAL DATA:

- » Cleans 8 folds at once in just a few minutes
- » No splashing while it cleans
- » 8 fingers to open the folds
- » Mounts simply on a garden hose
- » Dimensions: 9 x 5 x 22cm



Code	EAN13	Description	Qty	Unit price	Qty	Unit price	Qty	Unit price
8500114	4038755049834	Cartridge brush	1	33.40	4	31.73	12	30.06

CLEANING TANK FOR WELTICO CARTRIDGES

CLEANING TANK

- » Designed to allow the cartridges to soak in a solution of Welclean without wasting any product.
- » Stores the solution safely between cleans.
- » The Welclean solution is sold separately.
- » Compatible with C2, C3, C5, C6, C7 cartridges



- » Deep cleaning, descaling and removing embedded dirt from cartridges, filter bags and sand filters.
- » Concentrated product packaged in 5 litres containers, to be diluted in water.
- » Suitable for cartridge filters and sand filters.

Code	EAN13	Description	Qty	Unit price	Qty	Unit price	Qty	Unit price
85001141	3760094189285	Cleaning tank for Weltico C2 C3 C5 cartridges	1	79.40	2	75.43	6	71.46
85001139	3760094189292	Cleaning tank for Weltico C6 cartridges	1	86.70	2	82.37	6	78.03
85001140	3760094189308	Cleaning tank for Weltico C7 cartridges	1	94.10	2	89.40	6	84.69
85000401	3760094185119	Welclean filter cleaner, box of 8 tablets Weltico	1	17.39	24	16.47	36	14.64



P-AM FILTRATION PUMPS

TECHNICAL DATA

- » The P-AM filtration pump is fitted with hose tail outlet ports \varnothing 32 mm and \varnothing 38 mm,
- » Self-priming



1



	Code	EAN13	Description	Hmt	P1 (HP)	Qty	Unit price	Qty	Unit price	Qty	Unit price
1	50011000	3566835497219	Filtration pump P-AM 4 m ³ /h, single phase	3	0.45	1	138.70	8	131.77	32	124.83
	50021000	3566835497226	Filtration pump P-AM 6 m ³ /h, single phase	3	0.53	1	147.80	8	140.41	32	133.02

P-AP FILTRATION PUMPS

ECHNICAL DATA

- » The P-AP filtration pump is fitted with, two hose tails \varnothing 32/38 mm and 2 solvent unions \varnothing 50 mm, as standard,
- » Self-priming,
- » The pump is fitted with a pre-filter and basket.



2



	Code	EAN13	Description	Hmt	P1 (HP)	Qty	Unit price	Qty	Unit price	Qty	Unit price
2	50211200	3566835496366	Filtration pump P-AP 4 m ³ /h, 1ph	8	0.48	1	164.90	10	156.66	40	148.41
	50221200	3566835496724	Filtration pump P-AP 6 m ³ /h, 1ph	8	0.62	1	185.80	10	176.51	40	167.22
	50231200	3566835496731	Filtration pump P-AP 8 m ³ /h, 1ph	8	0.82	1	194.60	10	184.87	40	175.14
	50241200	3566835496748	Filtration pump P-AP 11 m ³ /h, 1ph	8	0.95	1	220.00	10	209.00	40	198.00

P-AMX FILTRATION PUMPS

TECHNICAL DATA

- » The P-AMX filtration pump is delivered with 1 solvent union \varnothing 50 mm and one solvent union \varnothing 63 mm as standard,
- » Self-priming,
- » The pump is fitted with a pre-filter and basket.



3



	Code	EAN13	Description	Hmt	P1 (HP)	Qty	Unit price	Qty	Unit price	Qty	Unit price
3	50311300	3566835496779	Filtration pump P-AMX 5 m ³ /h, 1ph	8	0.42	1	288.00	8	273.60	32	259.20
	50331300	3566835496816	Filtration pump P-AMX 10 m ³ /h, 1ph	8	0.62	1	302.00	8	286.90	32	271.80
	50351300	3566835496823	Filtration pump P-AMX 16 m ³ /h, 1ph	8	0.89	1	323.00	8	306.85	32	290.70
	50371300	3566835496830	Filtration pump P-AMX 22 m ³ /h, 1ph	8	1.10	1	384.00	8	364.80	32	345.60

LOGISTICS DATA	P-AM 4M ³ /H P-AM 6M ³ /H	P-AP 4M ³ /H P-AP 6M ³ /H	P-AP 8M ³ /H	P-AP 11M ³ /H	P-AMX 5M ³ /H P-AMX 10M ³ /H	P-AMX 16M ³ /H	P-AMX 22M ³ /H
BOX DIMENSIONS (LXLXH, CM)	32x16x21	49x22x28		60x40x32	58x21x33		
BOX WEIGHT (KG)	6	7	8	11	9.7	11.1	15.5



BADU SUPERPRO RP1 1/2 - RP2

TECHNICAL DATA:

- » May be used as a drop-in replacement for the "Super Pump" by Hayward and the "SuperFlo" pump by Pentair.
- » Pump compatible with saline water, max salt concentration 0.5 %, that is 5 g salt/l.
- » Transparent lid to check easily for debris.
- » Painted motor.
- » Adjustable unions simplify installation.
- » Easily serviceable 4-bolt design and handle for transport and installation.
- » Rp 1½ : Tapped 1½ inch inlet and outlet ports that receive the solvent female half unions, 50 mm, delivered with the pump.
- » Rp 2 : Tapped 2 inch inlet and outlet ports that receive the solvent female half unions, 63 mm, delivered with the pump.



Code	EAN13	Description	Qty	Unit price	Qty	Unit price	Qty	Unit price
BADU SUPERPRO RP1								
51501100	3566837235413	BADU SuperPro 8m ³ /h, Rp1"1/2, 0.5HP 1ph	1	261.00	3	247.95	6	234.90
51501300	3566837235420	BADU SuperPro 8m ³ /h, Rp1"1/2, 0.5HP 3ph	1	285.00	3	270.75	6	256.50
51502100	3566837235437	BADU SuperPro 11m ³ /h, Rp1"1/2, 0.7HP 1ph	1	270.00	3	256.50	6	243.00
51502300	3566837235444	BADU SuperPro 11m ³ /h, Rp1"1/2, 0.7HP 3ph	1	289.00	3	274.55	6	260.10
51503100	3566837235451	BADU SuperPro 14m ³ /h, Rp1"1/2, 0.9HP 1ph	1	304.00	3	288.80	6	273.60
51503300	3566837235468	BADU SuperPro 14m ³ /h, Rp1"1/2, 0.9HP 3ph	1	308.00	3	292.60	6	277.20
51504100	3566837235475	BADU SuperPro 18m ³ /h, Rp1"1/2, 1.1HP 1ph	1	313.00	3	297.35	6	281.70
51504300	3566837235482	BADU SuperPro 18m ³ /h, Rp1"1/2, 1.1HP 3ph	1	332.00	3	315.40	6	298.80
51505100	3566837235499	BADU SuperPro 22m ³ /h, Rp1"1/2, 1.4HP 1ph	1	369.00	3	350.55	6	332.10
51505300	3566837235505	BADU SuperPro 22m ³ /h, Rp1"1/2, 1.4HP 3ph	1	373.00	3	354.35	6	335.70
51506100	3566837235512	BADU SuperPro 27m ³ /h, Rp1"1/2, 1.8HP 1ph	1	350.00	3	332.50	6	315.00
51506300	3566837235529	BADU SuperPro 27m ³ /h, Rp1"1/2, 1.8HP 3ph	1	354.00	3	336.30	6	318.60
51507100	3566837235536	BADU SuperPro 30m ³ /h, Rp1"1/2, 2.5HP 1ph	1	588.00	3	558.60	6	529.20
51507300	3566837235543	BADU SuperPro 30m ³ /h, Rp1"1/2, 2.5HP 3ph	1	700.00	3	665.00	6	630.00
51508100	3566837235550	BADU SuperPro 36m ³ /h, Rp1"1/2, 3HP 1ph	1	662.00	3	628.90	6	595.80
51508300	3566837235567	BADU SuperPro 36m ³ /h, Rp1"1/2, 3HP 3ph	1	742.00	3	704.90	6	667.80
BADU SUPERPRO RP2								
51511100	3566837235574	BADU SuperPro 9m ³ /h, Rp2", 0.5HP 1ph	1	261.00	3	247.95	6	234.90
51511300	3566837235581	BADU SuperPro 9m ³ /h, Rp2", 0.5HP 3ph	1	285.00	3	270.75	6	256.50
51512100	3566837235598	BADU SuperPro 12m ³ /h, Rp2", 0.7HP 1ph	1	270.00	3	256.50	6	243.00
51512300	3566837235604	BADU SuperPro 12m ³ /h, Rp2", 0.7HP 3ph	1	289.00	3	274.55	6	260.10
51513100	3566837235611	BADU SuperPro 15m ³ /h, Rp2", 0.9HP 1ph	1	304.00	3	288.80	6	273.60
51513300	3566837235628	BADU SuperPro 15m ³ /h, Rp2", 0.9HP 3ph	1	308.00	3	292.60	6	277.20
51514100	3566837235635	BADU SuperPro 19m ³ /h, Rp2", 1.1HP 1ph	1	313.00	3	297.35	6	281.70
51514300	3566837235642	BADU SuperPro 19m ³ /h, Rp2", 1.1HP 3ph	1	332.00	3	315.40	6	298.80
51515100	3566837235659	BADU SuperPro 23m ³ /h, Rp2", 1.4HP 1ph	1	369.00	3	350.55	6	332.10
51515300	3566837235666	BADU SuperPro 23m ³ /h, Rp2", 1.4HP 3ph	1	373.00	3	354.35	6	335.70
51516100	3566837235673	BADU SuperPro 29m ³ /h, Rp2", 1.8HP 1ph	1	350.00	3	332.50	6	315.00
51516300	3566837235680	BADU SuperPro 29m ³ /h, Rp2", 1.8HP 3ph	1	354.00	3	336.30	6	318.60
51517100	3566837235697	BADU SuperPro 33m ³ /h, Rp2", 2.5HP 1ph	1	588.00	3	558.60	6	529.20
51517300	3566837235703	BADU SuperPro 33m ³ /h, Rp2", 2.5HP 3ph	1	700.00	3	665.00	6	630.00
51518100	3566837235710	BADU SuperPro 40m ³ /h, Rp2", 3HP 1ph	1	662.00	3	628.90	6	595.80
51518300	3566837235727	BADU SuperPro 40m ³ /h, Rp2", 3HP 3ph	1	742.00	3	704.90	6	667.80

Pentair® and SuperFlo® are brands belonging to Pentair Water Pool and Spa, Inc. or a company belonging to Pentair Water Pool and Spa, Inc.
Hayward® and Super Pump® are brands belonging to Hayward Industries, Inc.

ACCESSORIES FOR WOODEN POOLS

WOOD TREATMENT

INFOS

This product is formulated to protect cut surfaces (trimming, reworking ,etc.) of the wooden pool structure (or any other treated outdoor wood) against wood eating insects and fungus.



Code	EAN13	Description	Qty	Unit price	Qty	Unit price	Qty	Unit price
27900000	3566837189860	100ml bottle of wood treatment	1	10.00	6	9.50	12	9.00

PINE PLANT HOUSING FOR OCTAGONAL ABOVE-GROUND WOODEN POOLS

- » Provides housing and protection for technical elements close to the pool.
- » The housing is fitted with a lock.
- » The installation must be protected by an electrical panel equipped with a 30mA circuit breaker.



INFOS

Not compatible with rectangular pools.

Code	EAN13	Description	Qty	Unit price	Qty	Unit price	Qty	Unit price
27900010	3566837096472	Pine plant housing. Ht:120	1	232.00	4	220.40	8	208.80
27900015	3566837086589	Pine plant housing. Ht:133	1	246.00	4	233.70	8	221.40
27900020	3566837086596	Pine plant housing. Ht:146	1	256.00	4	243.20	8	230.40

PINE PLANT HOUSING, STRUCTURE ONLY

- » Wooden box 1200 × 1200 × 1100 (holds a 610 diameter filter and a pump).
- » Class IV treated pine, FSC certified.
- » Structure delivered empty.
- » Fitted with a lock.
- » Delivered as a flat pack to be assembled.

INFOS

The plant housing must be set on flat surface (it does not have a floor). It must be set against a wall (it does not have a back wall). It requires clearance height of 1.75m to allow opening of the lid.

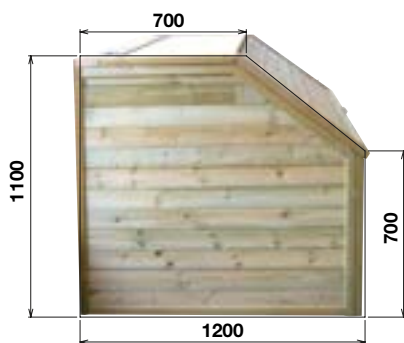

Code	EAN13	Description	Qty	Unit price	Qty	Unit price	Qty	Unit price
765000	3566837121679	Plant housing, class IV treated pine, height 1.10m, structure only	1	378.00	4	359.10	8	340.20

DELTA MS DRAINAGE MEMBRANE



- » Roll height of 1.50m.
- » Mandatory to protect the wood of in-ground or partially in-ground pools and insulate it from backfill.



Code	EAN13	Description	Qty	Unit price	Qty	Unit price	Qty	Unit price
3360650	3566837068875	Delta MS height 1.50m, 20m roll	1	108.10	4	102.70	8	97.29



INFOS

Each of our electrical panels are made of top quality components carefully selected on the basis of their excellent performance data. They are delivered with appropriate circuit breaker. They comply with the French electrical safety standard NF 60439-1 and the French EMC safety standards NF 55014 and NF 55104.

X	Circuit breaker	Power	
		1ph	3ph
2	1 to 1.6A	-	1/2 HP
3	1.6 to 2.5A	-	3/4 to 1 HP
4	2.5 to 4 A	1/2 HP	1,5 to 2 HP
5	4 to 6.3 A	3/4 HP	3 HP
6	6.3 to 10A	1 to 1.5 HP	4 HP

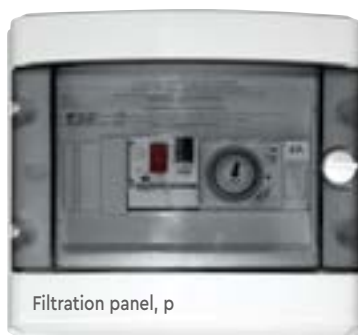

1

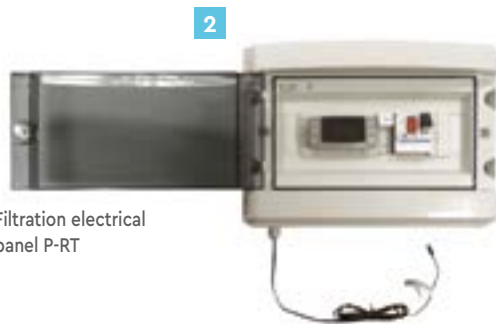

Filtration electrical panel P-RT

2

3



FILTRATION ELECTRICAL PANELS P

TECHNICAL DATA:

- » Hinge mounted glass door,
- » All the controls are protected behind the glass door,
- » Delivered with a circuit breaker (up to 10 Amp),
- » Terminal block to facilitate wiring,
- » Delivered with the necessary bushings, screws and cable glands,

» All our electrical panels are delivered with an appropriately rated circuit breaker.

INFOS

In order to select the appropriate circuit breaker, replace the letter X with the number corresponding to the required rating.

	Code	Description	Qty	Unit price	Qty	Unit price	Qty	Unit price
1	6800X0	Electrical panel P-000. with circuit breaker. no UW light	1	137.60	30	130.72	60	123.84
	6803X0	Electrical panel P-050. with circuit breaker for 1 50W LED UW light	1	211.00	30	200.45	60	189.90
	6808X0	Electrical panel P-100. with circuit breaker for 2 50W LED UW lights	1	224.00	30	212.80	60	201.60

FILTRATION ELECTRICAL PANELS P-RT

TECHNICAL DATA:

- » Automatic regulation of the length of the filtration cycle depending on the water temperature,
- » Temperature sensor with 6m cable,
- » IP 55 protection rating,
- » Titanium thermowell that is mounted on a 1/2" reducing tee or a saddle clamp.

INFOS

In order to select the appropriate circuit breaker, replace the letter X with the number corresponding to the required rating.

	Code	Description	Qty	Unit price	Qty	Unit price	Qty	Unit price
2	6801X0	Coffrand de filtration P-RT-000. avec disjoncteur. sans Underwater lights	1	258.00	30	245.10	60	232.20
	6804X0	Coffrand de filtration P-RT-050. avec disjoncteur pour 1 Underwater lights LED 50W	1	303.00	30	287.85	60	272.70
	6809X0	Coffrand de filtration P-RT-100. avec disjoncteur pour 2 Underwater lights LED 50W	1	314.00	30	298.30	60	282.60

ELECTRICAL PANEL AND UNDERWATER LIGHT(S) SET FOR WOODEN POOLS

TECHNICAL DATA:

- » Hinge mounted glass door,
- » All the controls are protected behind the glass door,
- » Terminal block to facilitate wiring,
- » Delivered with the necessary bushings, screws and cable glands,
- » Extra flat 50W underwater lights,
- » Stainless steel throughwall flange.

INFOS

The electrical panel 109920 can manage a 6.3A 1 ph filtration pump

	Code	EAN13	Description	Qty	Unit price	Qty	Unit price	Qty	Unit price
3	109900	3566835499282	Electrical panel + 1 UW light 50 W	1	207.00	18	196.65	36	186.30
	109920	3566837066840	Electrical panel & two 50 W underwater lights	1	427.00	18	405.65	36	384.30

ADAPTER PLUG

	Code	EAN13	Description	Qty	Unit price	Qty	Unit price	Qty	Unit price
	708900	3566837065966	Programmer/male connector, 230V/16A outlet & timer	1	29.00	10	27.55	20	26.10



Everything you need to guarantee success

For the experienced do-it-yourselfer who wants to build their pool themselves! To help out, BWT MyPOOL offers two kits, with or without liner, and for three pool sizes: small, medium or large.

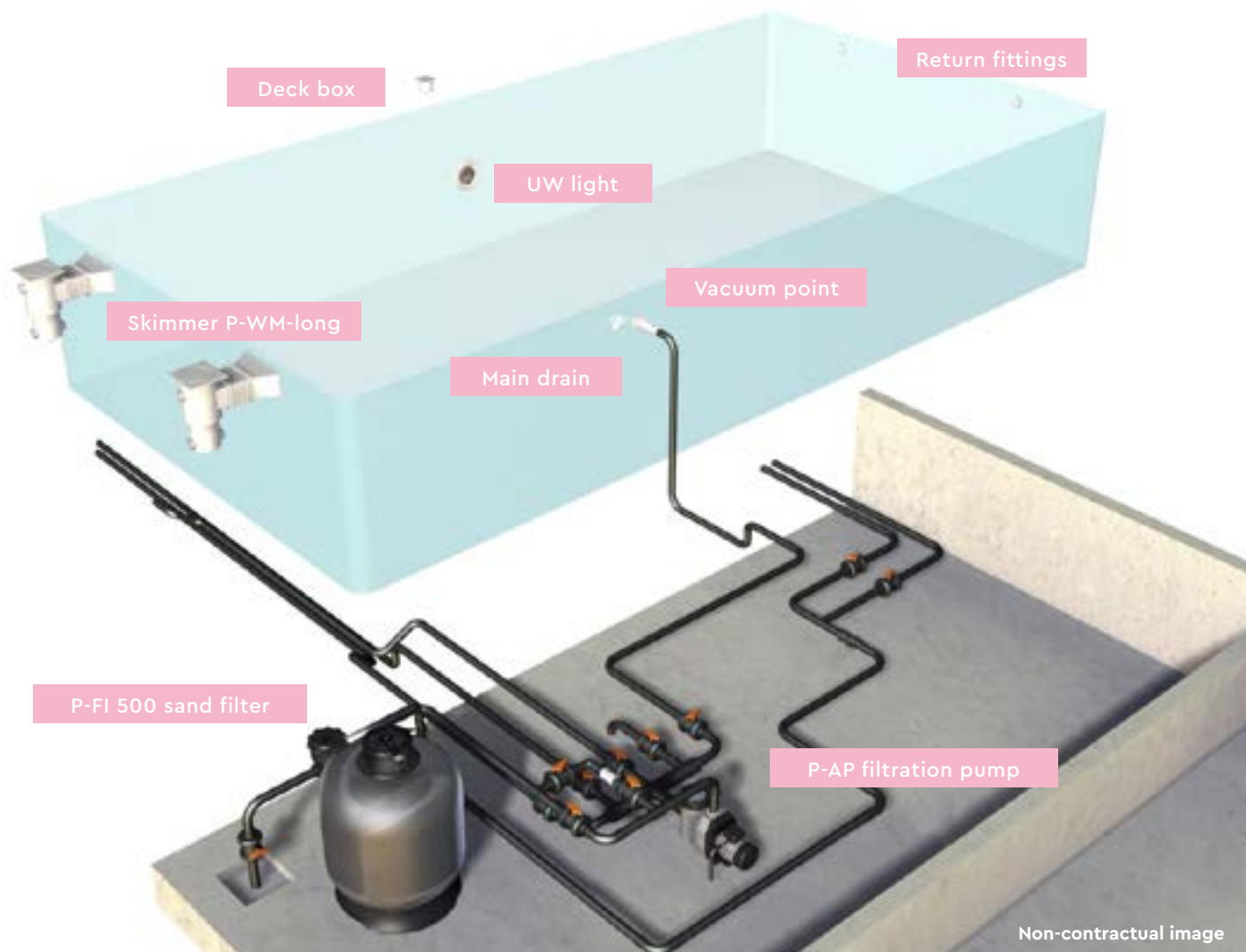

BWT MyPOOL has thought of everything, and kits include all the equipment and accessories that you need: filter, pump, pool fittings, pipe fittings, electrical panel, underlay, liner fastening system, cleaning accessories, and a liner if you chose this option.

KITS without LINER: Choose the kit depending on the pool volume.

KITS with LINER: Kit including a grey liner for pools of pre-defined dimensions*.

Désignation	Code	KITS WITHOUT LINER			KITS WITH LINER			
		30M ³	65M ³	85M ³	5X3 HT1,5	6X3 HT1,5	7X3 HT1,5	8X4 HT1,5
PUMPS								
P-AP filtration pump, 4m ³ /h, 1ph	50211200	-	-	-	1	-	-	-
P-AP filtration pump, 6m ³ /h, 1ph	50221200	-	-	-	-	1	-	-
P-AP filtration pump, 8m ³ /h, 1ph	50231200	1	1	1	1	1	1	1
P-AP filtration pump, 11m ³ /h, 1ph	50241200	-	1	-	-	-	-	1
P-AMX filtration pump, 16m ³ /h, 1ph	50351300	-	-	1	1	1	1	1
FILTERS								
P-FI 40 sand filter with 1"1/2 valve, grey	20070001	-	-	-	1	-	-	-
P-FI 500 sand filter with 1"1/2 valve, grey	20270001	1	-	-	-	1	1	1
P-FS 650 sand filter with 1"1/2 valve, grey	263000	-	1	1	-	-	-	-
Sand 0.6/1.25 - 25Kg bags	241109	2	3	3	1	2	2	2
Rolled gravel 2.00/4.00, 25Kg bags	-	-	1	1	-	-	-	-
POOL FITTINGS								
Skimmer P- GM-Long, liner, white	40061019	1	1	2	1	1	1	1
Return fitting + jet, liner, white	42030019	2	2	3	2	2	2	2
Main drain, liner, white	41012019	1	1	1	1	1	1	1
Vacuum point + cap, liner, white	42060019	1	1	1	1	1	1	1
LED UW light, liner, white	-	1	1	1	1	1	1	1
UW light deck box, white	45000019	1	1	1	1	1	1	1
PIPEWORK								
90° elbow 50mm, F/F solvent	1340059	13	13	18	13	13	13	13
3 part union 50mm, F/F solvent	1356059	5	5	5	5	5	5	5
Threaded nipple 50x1"1/2 F solvent x male screwed	1364059	1	1	1	1	1	1	1
Filtration manifold 3 x 50male / 63 female	-	2	2	2	2	2	2	2
Filtration manifold cap, 50/63	-	4	4	4	4	4	4	4
1/4 turn valve, 50mm, double union F/F solvent	1410009	5	5	5	5	5	5	5
Flexible PVC tubing, 50mm, 25m ring, per ml	1420059	50	50	50	50	50	50	50
Rigid PVC pipe, 16 Bars, 50mm, 1m bar	85006403	3	3	3	3	3	3	3
Pipe clips, 50mm	85006050	10	10	10	10	10	10	10
PVC pressure glue, 250ml	1396109	1	1	1	1	1	1	1
Special blue glue for flexible PVC tubing, 250ml	1396309	1	1	1	1	1	1	1
PVC stripper, 500ml	1396709	1	1	1	1	1	1	1
PTFE tape 12mm x 0.075mm x 12m	1397109	1	1	1	1	1	1	1
ELECTRICAL PANEL								
Filtration electrical panel P-50, 4 A circuit breaker.	680340	1	1	1	1	1	1	1
UNDERLAY								
Roll of Biotex 42m ² , per m ²	1821109	42	42	-	42	42	42	84
Roll of Biotex 63m ² , per m ²	1821209	-	-	63	-	-	-	-
Pot of underlay glue, 20Kg	3360919	1	1	3	1	1	1	1
LINER LOCKING TRACK								
Hung PVC straight 50mm, 2m strip, per m	1820119	18	28	32	16	18	20	24
CLEANING								
Telescopic pole, 1.00 to 3.00 m	9702950	1	1	1	1	1	1	1
Vacuum head, concrete, 8 wheels + brushes	9702400	1	1	1	1	1	1	1
Leaf rake	9702650	1	1	1	1	1	1	1
Test kit Chlorine - pH	9703800	1	1	1	1	1	1	1
LINER								
Liner P-75, rectangle 5x3 ht1.5, grey	72220040	-	-	-	1	-	-	-
Liner P-75, rectangle 6x3 ht1.5, grey	72220041	-	-	-	-	1	-	-
Liner P-75, rectangle 7x3 ht1.5, grey	72220042	-	-	-	-	-	1	-
Liner P-75, rectangle 8x4 ht1.5, grey	72220045	-	-	-	-	-	-	1
Kit code		49061019	49061119	49061219	49061519	49061619	49061719	49061819
EAN13		3566837220969	3566837220976	3566837220983	3566837220990	3566837221003	3566837221010	3566837221027
Kit prices		1,546.00	1,663.00	2,246.00	1,924.00	2,077.00	2,177.00	2,388.00

*Liner with a vertical corner radius of 15 cm



P-AS ALARM

- » The P-AS fall detection system was designed for in-ground family pools (maximum size: 10x5m), in compliance with the French safety standard NF P90-307 A1.
- » This alarm is the most popular fall detection system available on the market. It features a microprocessor that continuously monitors the pool status.
- » Powered by 4 LR-20 alkaline batteries (supplied), it has a powerful 100 dB siren.
- » In the event that an object falls into the pool, the P-AS alarm analyses the underwater wave and triggers the siren.
- » After bathing, the P-AS alarm resets automatically.



BOX DIMENSIONS (LXWXH):
53X29X23CM

Code	EAN13	Description	Qty	Unit price	Qty	Unit price	Qty	Unit price
6130000	3760137122132	P-AS alarm	1	294,00,	5	279,30,	10	264,60,

P-AM ALARM

The P-AM alarm is an economical and reliable system.

Although it provides excellent protection, it is not designed to comply with the French safety standard NF P 90-307-1 (April 2009) and must be installed in addition to another system that does comply with the standards in effect.

The ideal solution for camp sites, hotel, day care centres, etc.



THE P-AM ALARM COMPRISES:

- » Casing made of high density polyethylene,
- » Central control unit with integrated siren,
- » Wrist bands,
- » Charger 230 V/12 V,
- » Back-up battery (autonomy longer than 6 hours)

THE WRIST BAND:

- » Total safety, round the clock. The control unit can monitor an unlimited number of wrist bands.

PROXIMITY SENSOR:

- » Two pre-alarm systems may also be connected to the control unit.
- » The door open sensor and proximity sensor trigger a medium intensity alarm for 30 seconds, if no action is taken after 30 seconds, the alarm will sound at full power.
- » You are instantly alerted of an unsafe situation and you can act before any contact with the pool water.

	Code	EAN13	Description	Qty	Unit price	Qty	Unit price	Qty	Unit price
1	6159000	3566837056216	P-AM alarm with 2 wrist bands	1	567.00	5	538.65	10	510.30
OPTIONS									
2	6159109	3566837157630	Additional wrist band for P-AM alarm	1	67.90	5	64.51	10	61.11
3	6159409	3566837157647	Proximity sensor for P-AM alarm	1	161.40	5	153.33	10	145.26
4	6159459	3566837157661	Door open sensor. P-AM alarm	1	93.40	5	88.73	10	84.06
ACCESSORIES									
	6159359	3566837157678	Additional siren for P-AM alarm	1	287.00	5	272.65	10	258.30
	6159509	3566837157685	220V-14V charger for P-AM alarm	1	45.10	5	42.85	10	40.59
	6159559	3566837157692	12V. 2 Amp battery for P-AM alarm	1	28.90	5	27.46	10	26.01



SOLAR SHOWERS

- » Solar showers are the ideal environmental solution. The water is warmed by the sun's rays. No other energy source is required. The black colour allows the water reservoir to absorb and accumulate a maximum amount of heat from UV light.
- » The shower reservoirs are made of PVC and do not contain any hazardous chemicals.
- » Very easy to use, the water temperature can be adjusted using a mixing tap.



	Code	EAN13	Description	Qty	Unit price	Qty	Unit price	Qty	Unit price
1	848500	3566837151324	Solar shower with wide head and mixing tap, 35 litres	1	111.70	8	106.12	20	100.53
2	9705000	3566837060671	Solar shower, 2 elements, 18 litres	1	93.10	8	88.45	16	83.79

LADDER WITH 3 STAINLESS STEEL TREADS, TO BE MOUNTED ON WOODEN POOLS

- » 304 L stainless steel ladder,
- » Stainless steel treads with resin bumpers,
- » The upper section is fitted with anchor flanges to be mounted on the composite or wood coping,
- » The submerged section is fitted with buffers to protect the liner,
- » In the case of composite wood coping, two sets of counter plates will be needed to mount the ladder.



Code	EAN13	Description	Qty	Unit price	Qty	Unit price	Qty	Unit price
60622300	3566835508526	SS ladder, 3 treads, wooden pools	1	218.00	4	207.10	8	196.20
60922011	3566837066574	Amboise counter plate, set of 2	1	22.00	4	20.90	8	19.80



H²O STEPS

Two-sided ladder, designed so that the in-pool side lies flat against the pool wall to prevent a child from becoming caught. This section fills with water to ballast the ladder,

ADVANTAGES

- » Sécurité Child safety: the access section of the ladder can be swung up,
- » UV resistant polyethylene,
- » Comes with straps to fasten the ladder to the pool (between the ladder platform and the pool coping),

TECHNICAL DATA

- » Designed for aboveground pools, height 1.20m to 1.35m,
- » Maximum weight supported: 180Kg.



	Code	EAN13	Description	Qty	Unit price	Qty	Unit price	Qty	Unit price
1	927200	3566837151133	H2O steps only, interior	1	165.30	4	157.04	8	148.77
2	927700	3566837058241	H 2O steps + safety ladder, interior/ exterior	1	230.00	4	218.50	8	207.00

FIESTA STEPS

ADVANTAGES

- » Anti UV treated polyethylene,
- » Hand rails on both sides,
- » Non-slip, ergonomic and aesthetic,
- » Ballast in the bottom step for added stability,
- » Space under the step to allow the circulation of water to prevent stagnation and the growth of micro-organisms.

TECHNICAL DATA

- » Maximum weight supported: 180kg.



	Code	EAN13	Description	Qty	Unit price	Qty	Unit price	Qty	Unit price
3	927300	3566837058227	Fiesta steps only, interior	1	384.00	4	364.80	8	345.60
4	927400	3566837151140	Fiesta steps + safety ladder, interior/ exterior	1	670.00	4	636.50	8	603.00

SAFETY LADDER FOR H2O AND FIESTA STEPS

ADVANTAGES

- » Pool access ladder, to be position outside the pool,
- » Ladder compatible with H2O and FIESTA steps,
- » Child safety: the ladder can be swung up when the pool is not in use.



Code	EAN13	Description	Qty	Unit price	Qty	Unit price	Qty	Unit price
927600	3566837151126	Safety ladder for H ² O and Fiesta steps, exterior	1	176.70	4	167.87	8	159.03

MAJESTIC STEPS

The Majestic steps adapt to any pool - No need for bags! Simply pull out the cylinder out of the tread and fill it with sand

ADVANTAGES

- » Raised step to allow water to circulate underneath the steps to prevent the growth of algae.
- » Majestic steps are solid and spacious.
- » Suction cups provide for easy installation.
- » Includes a suction cup system and a place for an underwater light.

TECHNICAL DATA

- » Suitable for pools deeper than 90cm.
- » Made of virgin polyethylene.
- » 100% resin hand rail.
- » Non-slip, spacious treads.
- » UV resistant.

DIMENSIONS - POIDS

- » Height: 188cm (with ramp)
- » Ballast weight: 8Kg
- » Weight: 36Kg
- » Load bearing capacity: up to 182Kg

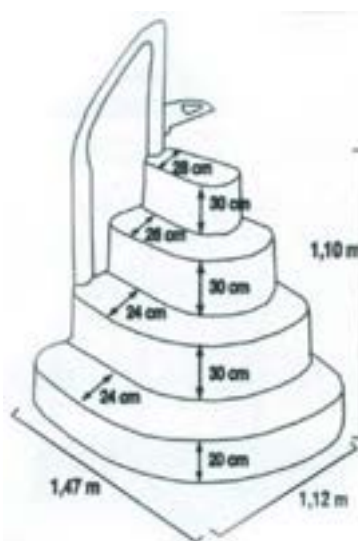

Excellent stability thanks to the ballast and suction cups.



Code	EAN13	Description	Qty	Unit price	Qty	Unit price	Qty	Unit price
927150	3566837170318	Majestic steps, in -pool	1	484.00	4	459.80	8	435.60



AQUA FLOW JET COUNTER SWIM UNIT

Aqua Flow Jet is a compact unit, delivered pre-assembled (2 x Aqua Flow Jet). Given its very reasonable price, it is ideal for low budget pools.



TECHNICAL DATA TECHNIQUES:

- » Flow rate: 60m³/h (2 x 30m³/h),
- » Power P1 at the input, 1.2 kW
- » Power P2 at the output, 0.8 kW
- » Pressure at the jet outlet: 0.4 bar,
- » Flow rate at 2m from the jet: 0.7m/s
- » Massage pressure: max. 1.3 bar,
- » Power supply: 230 V 1ph,
- » Adjustable and directional jets,
- » Separate pneumatic controls.
- » Code

ADVANTAGES

- » Completely pre-assembled to facilitate installation,
- » Adjustable and directional jets,
- » Pneumatic controls,
- » May be started/ stopped from within the pool,
- » By closing the valve, the pump may be removed without having to lower the water level in the pool.

	Code	EAN13	Description	Qty	Unit price	Qty	Unit price	Qty	Unit price
1	938000	3566837056469	Aqua Flow Jet double counter swim unit	1	984.00	2	934.80	4	885.60
2	939000	3566837089436	Aqua Flow Jet double counter swim unit. wooden pool	1	1,81.00	2	1,786.95	4	1,692.90
3	27435220	3566837096601	Pack of slats for AquaflowJet. octo+540 pool	1	82.00	2	77.90	4	73.80
	27436220	3566837096496	Pack of slats for AquaflowJet. octo+640 pool	1	90.00	2	85.50	4	81.00
	27438220	3566837096502	Pack of slats for AquaflowJet. octo+840 pool	1	99.00	2	94.05	4	89.10
	27484220	3566837096489	Pack of slats for AquaflowJet. rectangular pool	1	96.00	2	91.20	4	86.40

BADU JET OUTBOARD COUNTER SWIM UNIT



4 ACTIVE



5 PERLA / RIVA



6 STELLA

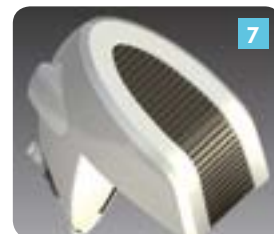

7

	Code	EAN13	Description.	Qty	Unit price	Qty	Unit price	Qty	Unit price
4	958000	3566837099275	BADU Jet outboard Active, 20m ³ /h 1.40 kW, 230 V 1ph	1	1,511.00	2	1,435.45	4	1,359.90
	958100	3566837099299	BADU Jet outboard Perla, colour LEDs, 40m ³ /h 2.30 kW, 230 V 1ph	1	2,530.00	2	2,403.50	4	2,277.00
5	958200	3566837099312	BADU Jet outboard Perla, colour LEDs, 40m ³ /h 2.10 kW, 230/400 V 3ph	1	2,470.00	2	2,346.50	4	2,223.00
	958300	3566837099398	BADU Jet outboard Riva, colour LEDs, 54m ³ /h 2.90 kW, 230 V 1ph*	1	3,135.00	2	2,978.25	4	2,821.50
5	958400	3566837099404	BADU Jet outboard Riva, colour LEDs, 58m ³ /h 3.30 kW, 230/400 V 3ph*	1	3,075.00	2	2,921.25	4	2,767.50
6	958500	3566837099411	BADU Jet outboard Stella, colour LEDs, 75m ³ /h 3.80 kW, 230/400 V 3ph*	1	3,561.00	2	3,382.95	4	3,204.90
7	958150	3566837099435	Option wood trim for counter swim units Perla, Riva and Stella	1	468.00	2	444.60	4	421.20

SWIM TETHER



The swim tether allows you to swim for pleasure, train, walk in water or do aqua fitness in pools as small as 1.50m x 3m. Comprised of a neoprene harness (waist circumference 60-105cm) and an elastic strap (length 200cm), it is the ideal system for aquatic activities in a small pool. The tether is delivered with a stainless steel D6 peg bushing to fasten it to the pool deck.



Code	EAN13	Description	Qty	Unit price	Qty	Unit price	Qty	Unit price
27781183	3566837184742	Swim tether with peg bushing	1	33.90	6	32.21	12	30.51

SKAMPER RAMP FOR ANIMALS



Allows animals to scamper out of the pool to safety. The ramp is made of thick plastic. It is light (2.5kg), hard wearing and very durable. The ramp is easy to remove from the water while the pool is in use. The ramp is designed along the principal that all living beings can see the colour white. Animals will see the ramp rising from the water and will realise that they have a way of exiting the pool themselves. The Skamper-Ramp can be used in an pool, and even with boats and in ports. Furthermore it protects the liner and boat hull against scratches. The Skamper-Ramp is sold all over the world and has twice been voted one of the "TOP 50 PRODUCTS" by the leading pool magazine in the United States. The Skamper-Ramp has received the seal of approval from the American Pet Association.



TECHNICAL DATA

- » Designed to bear loads of up to 100Kg
- » UV stable, resistant to pool chemicals
- » Adapts to nearly every pool
- » Also for boats and ports
- » Height: 68.6cm / Width: 34.30cm
- » Thickness: 6.35cm / weight 2.5Kg

Code	EAN13	Description	Qty	Unit price	Qty	Unit price	Qty	Unit price
85003655	769397146202	Skamper Ramp for animals 1,84.00	1	92.70	4	88.07	12	83.43



02

BWT myPool Heating

INVERTER HEAT PUMPS

36



INVERTER TECHNOLOGY FOR MORE COMFORT

INVERTER SYSTEM:

The Comfortline Inverter heat pump compressor runs at between 20% and 80% of its capacity depending on the operating conditions and the outdoor temperature.

The Comfortline Inverter heat pump captures heat calories from the air and transfers them to your pool water.

At the beginning of the pool season, when the heating demand is high, the Inverter compressor and the fan run at high speed (around 100%). As the pool water temperature approaches the set point, the Inverter compressor reduces its heating capacity and runs at lower speeds. This operating mode generates significant energy savings.

TECHNICAL SPECIFICATIONS:

- » GMCC compressor,
- » Titanium heat exchanger,
- » Magnetic flow switch, allows complete isolation of water from electricity,
- » All the copper tubes in the heat pump are silver welded. This welding technique prevents risks associated with gas leaks,

MAIN ADVANTAGES:

Runs at air temperatures between 0 at 35°C (depending on the relative humidity) and so prolongs your pool season. Inverter heat pumps have an average COP of 9 under the following operating conditions: Air 26°C, Water 15°C, Humidity 80%*.

DIGITAL REGULATOR:

The high and low pressure limiters, the flow switch, the cycle inversion defrosting system and the 5 temperature sensors are all controlled by a digital regulator to optimise protection of the heat pump and to ensure precise control of the pool water temperature.

CASING:

The Comfortline Inverter heat pump casing is made of galvanised steel coated with a protective polymer. This protective, anticorrosion polymer coating is longer lasting and more efficient.

- » "Blue Fin" treated evaporator,
- » Stainless steel screws,
- » Elegant small size, small footprint,
- » Runs silently (Inverter technology),
- » Simple to install, easy to maintain.

- » HP-BOOSTER technology,
- » Results in a COP 20% higher than conventional On/Off heat pumps on the market.

OPERATES DOWN TO 0°

GALVANISED STEEL CABINET

4 WAY VALVE DEFROSTING BY CYCLE INVERSION





COMFORTLINE INVERTER HEAT PUMPS



Code	EAN13	Description	Qty	Unit price	Qty	Unit price	Qty	Unit price
7730000	3566837234874	Comfortline heat pump BPNR05 5 kW	1	734.00	2	676.40	6	640.80
7731000	3566837234881	Comfortline heat pump BPNCR06 6 kW	1	754.00	2	695.40	6	658.80
7732000	3566837234898	Comfortline heat pump BPNCR08 8 kW	1	943.00	2	869.25	6	823.50
7850060	3566837126476	By-pass RC38 or 45 for Comfortline Inverter heat pump	1	100.50	2	95.48	6	90.45

Modèles	BPNR05	BPNR06	BPNR08
Code	7730000	7731000	7732000
Recommended pool volume (m ³)	12~25	14~28	20~35
Operating temperature ranges (°C)	0~43		
OPERATING CONDITIONS: AIR 26°C, WATER 26°C, HUMIDITY 80%*			
Heating capacity (kW)	5,0	6,0	8,0
C.O.P.	9.5~6.0	9.5~5.9	9.1~5.6
OPERATING CONDITIONS: AIR 15°C, WATER 26°C, HUMIDITY 70%*			
Heating capacity (kW)	3,6	4,3	6,0
C.O.P.	6.0~4.3	5.9~4.4	5.9~4.1
Rated power (kW)	0.29~0.83	0.29~1.0	0.34~1.4
Refrigerant	R32		
Rated current (A)	1.26~3.61	1.26~4.2	1.48~6.0
Power supply	230 V / 1ph / 50 Hz		
Recommended water flow rate (m ³ /h)	2~4	2~4	2~4
Acoustic power at 1m dB(A) / 10m dB(A)	18.8~30.2	19.8~31.2	20.8~31.1
Heat exchanger	Titanium spiral tube in PVC		
Cabinet	Plastic coated metallic casing		
Hydraulic connections (mm)	50		
Net weight/ Gross weight (Kg)	42	42	46
Dimensions - LxWxH (mm)	744x359x648	744x359x648	864x359x648

* Data is valid under the following conditions: Pool covered with an isothermal cover at night. Filtration running 15 hours a day during the heating season: from May 1st to September 15th. If operating under different conditions, please choose a more powerful model.



A vertical background image showing a close-up of water splashing, with a blue-to-purple gradient overlay. The number '03' is printed in large white font over the image.

03

BWT myPool Water treatment and maintenance

POOL CHEMICALS	40
WATER REGULATION	44
AUTOMATIC CLEANER	45
POOL ROBOTS	46
MAINTENANCE ACCESSORIES	48



INFOS Example shown, 5Kg pot



MULTIFUNCTION TABLETS (NON COMBUSTIVE)

- » Destroys micro-organisms.
- » Flocculates suspended particles.
- » Renders water crystal clear.

CHLORINE TABLETS (NON COMBUSTIVE)

- » Maintains a stable Chlorine concentration.
- » Continuous disinfection of the pool water.
- » Inhibits the growth of algae.

BLOC 500 (CHLORINE)

- » 500g block of Chlorine, slow even release.
- » Contains 99% stabilised slow release Chlorine.
- » Provides 15 days water treatment.

CHLORIT

- » Suitable for non-saline water.
- » Chlorine without stabiliser, does not add Cyanuric acid to the water.

CHLORIT 300G STICKS

- » Suitable for soft water.
- » Slow release product.
- » Chlorine without stabiliser, does not add Cyanuric acid to the water.

SHOCK CHLORINE PELLETS

- » Increases the Chlorine concentration rapidly and destroys micro-organisms.
- » Dissolves quickly and completely.

CHLORINE GRANULES 60

- » Fast dissolving stabilised Chlorine.
- » Contains approx 56% stabilised Chlorine.

2 LIQUID CHLORINE 36°

- » Calcium sequestering agent.
- » Does not contain stabiliser.
- » Provides continuous chlorination using automatic regulation and a dosing pump.

BROMINE PELLETS

- » Slow dissolving 20 g pellets.
- » Oxidises and destroys organic impurities.
- » Gentle of the eyes and skin, does not give rise to unpleasant odours.

BROMINE ACTIVATOR

- » Shock disinfection.
- » Reduces turbidity, increases water clarity and reduces irritation of the eyes and strong Chlorine odours by eliminating Chloramines.
- » Allows regeneration of Bromine.

1

Code	EAN13	Description	Qty	Unit price	Qty	Unit price	Qty	Unit price
8995070	3661931262362	Senet piscine – Multifunction tablets – 5Kg	4	25.80	12	24.51	36	23.22
8995020	3661931262812	Senet piscine – Cl slow release tablets – 5Kg	4	25.80	12	24.51	36	23.22
8995000	3661931270350	Senet piscine – Cl slow release 500g tablets – 5Kg	4	27.40	12	26.03	36	24.66
8995100	3661931257573	Senet piscine – Chlorit – 5Kg	4	34.50	12	32.78	36	31.05
8995140	3566837212209	Senet piscine – Chlorit, 300g stick – 5.4Kg	4	40.50	12	38.48	36	36.45
8995120	3661931253391	Senet piscine – Cl shock 20g pellets – 5Kg	4	20.00	12	19.00	36	18.00
8995150	3661931257290	Senet piscine – Chlorine granules 60 – 5Kg	4	23.00	12	21.85	36	20.70
8995450	3661931270336	Senet piscine – Liquid Chlorine – 10L	2	14.70	6	13.97	14	13.23
8995600	3661931269828	Senet piscine – Bromine 20g pellet – 5Kg	4	66.80	12	63.46	36	60.12
8995620	3566837160586	Senet piscine – Bromine activator – 5Kg	4	32.40	12	30.78	36	29.16

POOL CHEMICALS - ALGAECIDE AND WINTERIZING 



1 ALGICIDE 100

- » Preventative and curative action.
- » Inhibits the growth of algae and eliminates algae present in the water.
- » Compatible with all types of water treatments and pool finishes.

ALGICIDE 200

- » Dual action: preventative and curative.
- » Eliminates micro-algae and inhibits their growth.
- » Concentrated, non-foaming preventative and curative algaecide.

ALGICIDE

- » Multi-function algaecide with a preventative and curative action, eliminates limescale.
- » It flocculates organic matter so that it can be retained by the filter.
- » It slows down the deposition of limescale, the development of rust spots and limits pH fluctuations.
- » When used simultaneously with Chlorine or Bromine, it reduces the consumption of these chemicals.
- » Non-foaming.

2 ALGICIDE TARGETING YELLOW ALGAE

- » Algaecide eliminates yellow algae.
- » Settles on the pool floor and against the pool walls.
- » Compatible with all types of water treatment.

WINTERIZING

- » Algaecide specifically for winterizing.
- » Inhibits the growth of algae.
- » Prevents the deposition of limescale.

SUPER WINTERIZING

- » Concentrated winter treatment with 4 broad spectrum actions: algaecide, fungicide, bactericide and anti-scale.
- » Compatible with all types of water treatment.
- » Does not contain Copper Sulphate, EDTA or polyphosphates.
- » To be used when water temperature < 16°C. To be poured in front of the return fittings.
- » Non-foaming.

SOFT (ACTIVE OXYGEN)

- » Active Oxygen based disinfectant enriched with quaternary Ammonium with a residual disinfectant effect.
- » Does not contain Chlorine, odourless, does not alter the pH.
- » Gentle on the skin.
- » Compatible with UV treatment.

3 SHOCK TREATMENT

- » Contains 35% Hydrogen Peroxide.
- » Powerful oxidiser used as a shock treatment.
- » Rapidly eliminates organic matter present in the water in the event of high temperatures or a high bather load.

	Code	EAN13	Description	Qty	Unit price	Qty	Unit price	Qty	Unit price
1	8995420	3661931257917	Senet piscine – Algicide 100 – 5L	4	9.80	12	9.31	36	8.82
	8995410	3661931255425	Senet piscine – Concentrated algaecide – 5L	4	10.60	12	10.07	36	9.54
	8995440	3566837212223	enet piscine – Multi-function algaecide – 5L	4	9.70	12	9.22	36	8.73
2	8995425	3661931276215	Senet piscine – Algicide targeting yellow algae – 1L	6	19.90	12	18.91	36	17.91
	8995990	3661931256071	Senet piscine – Winterizing – 5L	4	11.40	12	10.83	36	10.26
	8995980	3661931250062	Senet piscine – Winterizing super – 5L	4	15.90	12	15.11	36	14.31
	8995500	3661931257542	Senet piscine – Soft liquid- 20L	1	45.60	12	43.32	36	41.04
3	8995400	3661931256576	Senet piscine – Shock treatment – 5L	4	11.20	12	10.64	36	10.08

POOL CHEMICALS - MAINTENANCE 



- CAL**
- » Prevents the deposition of limescale in hard water, even heated.
 - » Recommended for water : TH>200 ppm.
 - » Poured directly in front of the return fittings while filtration is running.
 - » Contains sequestering agents, does not contain EDTA or phosphates.

- FILTER AND ELECTRODE DESCALER**
- » Removes limescale deposits and sedimentation from the sand filter and electrodes.
 - » Dosage depends on the size of the filter. Slight foaming action.

- ALKALINE WATER LINE CLEANER**
- » Cleans deposits and removes grease from the water line.
 - » Suitable for all types of pool finish.
 - » Acts on organic matter.
 - » Apply the cream and rub evenly.

- ACID WATER LINE CLEANER**
- » Selective acid cleaner for the water line.
 - » Removes mineral materials deposited along the water line.
 - » Pour a small amount onto a sponge and rub the soiled area.

- METAFLCOC**
- » Metallic ion sequestering agent.
 - » Prevents the deposition of dissolved metals.

- » LIQUID FLOCCULANT**
- » Clarifying agent that create flocculates that are bigger than usual.
 - » Compatible with all pool chemicals.
 - » Use only with sand filters.

INFOS

WELCLEAN FILTER CLEANER

Solution for the Weltico cartridge cleaning tank.

See page **XXXX**



- FLOVIL FLOCCULANTS**
- » Improves the retention capacity of sand filters, cartridge filters and bag filters up to 5 micron.
 - » Compatible with all types of pool water treatment.
 - » Acts quickly, in just a few hours.

- FLOCCULANT FOR FILTERS**
- » Odourless, does not create and discomfort for bathers.

- SHOCK FLOCCULANT**
- » Continuous use.
 - » One-off use (after winterizing, heavy rain, high bather load or on water that has "turned").

- FLOCCULANT AND ALGICIDE DUOS**
- » Same actions ad the flocculant.
 - » Also inhibits the growth of algae.



- FLOCCULANT SOCK**
- » Pre-dosed, long acting flocculant.
 - » Improves filter performance.
 - » Renders water crystal clear.
 - » Reduces the consumption of disinfectant.

- CHLORINE, SMALL POOLS**
- » 3.3g pellets of stabilised Chlorine with 44.8% active Chlorine.
 - » Rapidly increases Chlorine concentration.
 - » Eliminates micro-organisms and acts against

- the destructive effect of UV light.
- » Dissolves completely and rapidly.
- » May be used in hard

- POOL-GRADE SALT IN PELLETS**
- » 25Kg bag.
 - » Compliant with the French standard NF EN 16401.

Code	EAN13	Description	Qty	Unit price	Qty	Unit price	Qty	Unit price		
	8995650	3566837220525	Senet piscine - Cal 5L	4	4.25	12	4.04	36	3.83	
1	8995680	3661931257962	Senet piscine - Filter descaler - 5L	4	7.90	12	7.51	36	7.11	
	8995435	3661931256569	Senet piscine - Water line cleaner - 1L	6	5.90	12	5.61	36	5.31	
	8995430	3661931255418	Senet piscine - Water line acid gel - 1L	4	4.83	12	4.59	36	4.35	
2	8995520	3566837212230	Senet piscine - Metallic ion sequestering agent - 1L	6	9.10	12	8.65	36	8.19	
	8995910	3661931255401	Senet piscine - Liquid flocculant- 5L	4	8.30	12	7.89	36	7.47	
	85000401	3760094185119	Welclean filter cleaner, box of 8 tablets, Weltico	Page 22						
3	85000402	3760094188141	Flocculant Flovil for filters, Weltico	4	14.16	20	13.41	40	11.92	
4	85000403	3760094185041	Flocculant Flovil Shock, Weltico	4	13.87	12	13.14	36	11.68	
5	85000404	3760094185072	Flovil Duo Flocculant and algicide, Weltico	4	15.68	12	14.85	36	13.20	
6	8995900	3661931265080	Senet piscine - Flocculant sock 1Kg	12	4.51	24	4.28	48	4.06	
7	8995930	3566837212247	Senet piscine - Chlorine, small pool 500 gr, set of 12	4	55.50	12	52.73	36	49.95	
	9109110	3566837156848	BWT myPool pool grade salt. 1000Kg	1	447.00	12	424.65	24	402.30	
	81529	3566837157159	Freight charges. 1 pallet of salt	POA						

POOL CHEMICALS - WATER EQUILIBRIUM 



PH MINUS LIQUID

- » Rapidly lowers the pH.
- » Compatible with automatic pH regulation systems.
- » Compatible with all types of pool water treatment.

PH MINUS POWDER

- » Lowers the pH rapidly.
- » Compatible with all types of water treatment.

PH PLUS LIQUID

- » Rapidly increase the pH (highly concentrated base).
- » Compatible with automatic pH regulation systems.

PH PLUS POWDER

- » Rapidly increase the pH.
- » Compatible with all types of water treatment.

CHLORESTAB

- » Protects Chlorine against destruction by UV light.
- » Regulates and decreases the consumption of Chlorine.
- » Improves the efficacy of Chlorine

TAC +

- » Increases the Total Alkalinity (TAC).

	Code	EAN13	Description	Qty	Unit price	Qty	Unit price	Qty	Unit price
1	8995700	3661931274327	Senet piscine – pH minus liquid – 5L	4	6.80	12	6.46	36	6.12
	8995210	3661931255531	Senet piscine – pH minus powder – 5Kg	4	9.10	12	8.65	36	8.19
2	8995810	3661931271500	Senet piscine – Ph plus liquid – 10L	2	27.80	6	26.41	14	25.02
	8995310	3661931255517	Senet piscine – pH plus powder – 5Kg	4	8.50	12	8.08	36	7.65
3	8995170	3661931253827	Senet piscine – Chlorestab 1Kg	6	6.30	12	5.99	36	5.67
4	8995050	3661931257283	Senet piscine – TAC+ – 5Kg	5	11.30	12	10.74	36	10.17

SPA WATER TREATMENT CHEMICALS 



SPA DISINFECTANT

- » Eliminates bacteria.
- » Removes organic impurities from the water.

SPA ANT-FOAMING AGENT

- » Prevents the formation of foam in the spa.

FLOCCULANT FOR SPAS

- » Improves filtration finesse of cartridge, sand and bag filters up to 5 microns
- » Compatible with all types of spa water treatment, with or without Chlorine.
- » Acts in a few hours, odourless, does not cause any discomfort to bathers

STARTER KIT

- » 1 Anti-foaming agent
- » 1 disinfectant
- » 1 PH plus
- » 1 PH minus
- » 10 test strips
- » 1 dosing jug and 1 instruction booklet

	Code	EAN13	Description	Qty	Unit price	Qty	Unit price	Qty	Unit price
5	8995950	3661931270558	Senet spa – Active Oxygen, 20g, 1Kg	6	17.80	12	16.91	36	16.02
6	8995940	3661931274099	Senet spa – Anti-foaming agent, 1L	6	5.60	12	5.32	36	5.04
7	85000405	3760094185089	Floculent Flovil Spa. Weltico	4	12.92	12	12.24	36	10.88
8	8995970	3661931256538	Senet spa – Start up kit	6	53.00	12	50.35	36	47.70

WATER REGULATION

DECHLORINATOR



THE RIGHT THING FOR THE ENVIRONMENT

- » Being highly aware of the impact that chlorinated water can have on the environment, Procopi developed a new product: the back wash water dechlorinator.
- » The system can be installed quickly and easily on the waste line of any filter.
- » During a back wash, or while draining the pool, waste chlorinated water is mixed with a neutralising agent, the resulting dechlorinated water can then be released to waste.

- » The quantity of neutralising agent injected will depend on the flow rate of the filtration pump.
- » The dechlorinator can be adapted to any of the Proswell pumps by adjusting the valve.
- » The neutralised water can be stored and subsequently used to water the garden or wash the car.

	Code	EAN13	Description	Qty	Unit price	Qty	Unit price	Qty	Unit price
1	9120100	3566837075460	Back wash water dechlorinator, 7L	1	184.80	10	175.56	20	166.32
2	8995590	3566837156763	Purissimeau - Neutral 5L	4	10.10	64	9.60	128	9.09

AUTOMATIC REGULATION



	Code	EAN13	Description	Qty	Unit price	Qty	Unit price	Qty	Unit price
	9167900	3566837077082	Regul Eco pH - peristaltic, LED	1	252.00	4	239.40	10	226.80

THE POOLCLENER AUTOMATIC CLEANER



THE POOLCLENER IS WELL MADE AND HARDWEARING, AND RUNS VERY QUIETLY.

- » An impeller in the PoolCleaner drives the wheels and moves the cleaner: the impeller's clever design and top quality manufacturing ensure silent operation, even at full power.
- » For even freer movement, The PoolCleaner is plugged into a swivel connection.
- » To ensure easy maintenance and a longer service life, The PoolCleaner is entirely mechanical.

TECHNICAL SPECIFICATIONS:

- » Plugs simply into a suction fitting (delivered with 8 hose sections).
- » The PoolCleaner requires a minimum flow rate of 5m³/h to operate.
- » Installed in just a few minutes.
- » The PoolCleaner does not require any parameter setting.
- » Changes direction automatically.

YOU'LL NEED TO LISTEN REALLY HARD TO HEAR IT!... AND ADMIRE ITS PERFORMANCE



INFOS

BOX DIMENSIONS (LxWxH) : 103x33x31cm
Weight: 8Kg

Code	EAN13	Description	Qty	Unit price	Qty	Unit price	Qty	Unit price
1021800	3566837120948	The PoolCleaner, 2 wheel automatic cleaner, liner - paint - polyester	1	301.00	8	285.95	16	270.90

AUTOMATIC CLEANER

DESIGNED FOR ALL POOL TYPES, THESE CLEANERS ARE VERY EASY TO USE.

- » Simply plug the cleaner directly into a vacuum point and it's ready to go, it sucks up everything in its path, nothing escapes.
- » It is compatible with pools of every shape and size.



TECHNICAL SPECIFICATIONS:

- » Easy to use, installation takes just a few minutes.
- » Designed for in-ground and above-ground family pools.
- » Cleans quickly and silently.



INFOS

BOX DIMENSIONS (LxWxH) :

1 108x48x13 cm, 7Kg

2 94x43x17 cm, 7.2Kg

	Code	EAN13	Description	Qty	Unit price	Qty	Unit price	Qty	Unit price
1	9704150	3566837130893	Hydraulic pool vacuum	1	63.90	12	60.71	24	57.51
2	9700000	3566837061029	Automatic cleaner, 13 hose sections, length 0.8m	1	153.00	12	145.35	24	137.70

JETVAC



TECHNICAL SPECIFICATIONS:

- » Compatible with all pool shapes,
- » Compatible with all pool contours,
- » Inner lining: PVC, polyester, tiles or decorative plaster,
- » Pool dimensions: Maximum 6 x 11m,
- » Material used: mass dyed ABS,
- » Weight: 2.6Kg (robot only), 6.9Kg (total weight),
- » Length of the power cable: 12.5m (5 modules, length 2.45m),
- » Booster: Between 0.75 and 1.20kW,
- » Accessories not included: Booster pump, electrical panel.



INFOS

BOX DIMENSIONS (LxWxH) :

51x50x32cm
Weight: 7Kg

	Code	EAN13	Description	Qty	Unit price	Qty	Unit price	Qty	Unit price
3	1004000	3566837059897	Jet-Vac, no booster pump, 12.50m hose	1	424.00	4	402.80	12	381.60
4	1004900	3566837156794	Jet-Vac booster 1HP, 230V 1ph	1	309.00	4	293.55	12	278.10
5	689269	3566837157722	P-BA electrical panel, 10A	1	188.90	4	179.46	12	170.01

**ROBOT ÉLECTRIQUE ÉCONOMIQUE
AVEC OPTION PANNEAU SOLAIRE**

Les robots Clean & Go E15 et E20 sont adaptés pour toutes les formes de piscines simples, ils ne nécessitent aucune installation particulière.

Ils permettent d'effectuer un nettoyage parfait du fond de la piscine.

Ce sont des appareils compacts, qui se composent d'un moteur de traction et d'une cartouche de filtration lavable permettant de retenir les impuretés.

La faible consommation électrique et l'option à panneau solaire font des Clean & Go, des robots eco-responsables.



1
Support anti-pivot
Pas de torsion possible

Caractéristiques techniques générales

MODÈLE	E15	E20
LONGUEUR DU CÂBLE ÉLECTRIQUE (M)	9	12
VITESSE DE DÉPLACEMENT RÉGLABLE (CM/SEC)	10 à 16	12 à 19
ZONE D'ASPIRATION ET DE NETTOYAGE	Fond plat et pente à 10°	Fond plat et pente à 30°
ALIMENTATION ÉLECTRIQUE	230V/50 Hz	
MODES DE FONCTIONNEMENT POSSIBLES :	- une alimentation électrique (5W), ou - un panneau solaire en mode Eco (15 W)	- une alimentation électrique (12W), ou - un panneau solaire en mode Eco (20 W)
POMPE À DOUBLE JET		
CYCLES DE NETTOYAGE	1h ou 2h	
TYPE DE PANIER	Ramasse débris en nylon	Ramasse débris en inox
POIDS NET / POIDS BRUT (KG)	4,4	
POIDS DU CARTON (KG)	7	8
DIMENSIONS - LXPXH (MM)	410 x 350 x 260	
DIMENSIONS DU CARTON - LXLXH (CM)	44 x 38 x 36	

CARACTÉRISTIQUES TECHNIQUES DES PANNEAUX SOLAIRES :

- » Puissance : 5 W pour la version E15 et 12 W pour la version E20,
- » Autonomie du panneau solaire :
1h pour la version 5 W (2), 3h pour la version 12 W (3)
- » Batterie rechargeable,
- » Support anti-pivot évitant la torsion du câble.

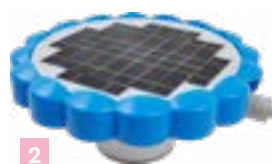

	Code	EAN13	Désignation	Qté	Prix H.T. unitaire	Qté	Prix H.T. unitaire	Qté	Prix H.T. unitaire
1	1014100	3566837179281	Robot Clean & Go E15, avec câble de 9 m	1	385,00	4	365,75	12	346,50
	1014140	3566837179304	Robot Clean & Go E20, avec câble de 12 m	1	428,00	4	406,60	12	385,20
OPTIONS									
2	1014170	3566837179311	Panneau solaire pour robots Clean & Go E15 et E20, 5 Watts	1	86,40	4	82,08	12	77,76
3	1014180	3566837179373	Panneau solaire pour robots Clean & Go E15 et E20, 12 Watts	1	216,00	4	205,20	12	194,40



ROBOT STAR VAC II - NG

Star Vac II NG robots are very easy to use, simply plug and play. Star Vac II NG are suitable for pools of all shapes up to a maximum water surface area of 80m².

Optimised programming allows the robot to adapt to all types of pool waterproofing, efficiently cleaning the pool floor, walls and water line.

THE STAR VAC II NG ROBOT FEATURES 2 CLEANING CYCLES:

- » A 1 1/2 hour cycle to clean the pool floor.
- » A 3 hour cycle to clean the pool floor, walls and water line at the height of the pool season.
- » It is a compact machine comprised of a motor, a filtration pump and a large capacity, reusable filtration bag to trap debris.



INFOS
BOX DIMENSIONS (LxWxH) :
 52x52x52cm
Weight : 21Kg

1



TECHNICAL DATA:

- » 100% autonomous cleaner,
- » Length of the electrical cable: 18 m,
- » Vacuums, cleans the pool floor, walls and water line,
- » Scanning rate: 550m²/h,
- » Electrical consumption: 185 W / 12 V,
- » Power supply: 230 V / 50 Hz,
- » Pump: 24 V DC,
- » No Water' protection system,
- » No buoyancy adjustment,
- » Cleaning cycles: 1 1/2 hours – floor, 3 hours – floor+walls+water line,
- » Delivered with a transport trolley,
- » Delivered with 1 reusable filtration bag and 5 disposable bags,
- » Simple to use,
- » Easy to maintain.

2



	Code	EAN13	Description	Qty	Unit price	Qty	Unit price	Qty	Unit price
1	1014000	3566837119959	Star Vac II NG – with transport trolley and 18m floating cable	1	946.00	4	898.70	12	851.40
WEAR PARTS									
2	1014001	3566837131302	Disposable bags for Star Vac II NG, set of 5	1	32.00	4	30.40	12	28.80

ROBOT TRIVAC 500

The only robot that also cleans the skims the surface of your pool.



TECHNICAL DATA

- » **Easy:** twist the setting to "floor" or "surface", the robot takes care of the rest.
- » **Efficient:** optimal scanning of the pool. It's high power Aqua-Drive propulsion system and sweep hose ensure both speed and access to places that are most difficult to reach (corners, steps; etc.).
- » **Hard-wearing:** the casing, that is fitted with wheels, easily absorbs impacts and the robot does not get blocked against obstacles. This ingenious system protects both the robot and the pool waterproofing.
- » **Constant motion:** its "back-up" function allows it to turn around, allowing it to move freely around the pool without getting blocked.
- » **Productive:** its large capacity a Kg (patented) prevents the robot from slowing down when the bag is full.

	Code	EAN13	Description	Qty	Unit price	Qty	Unit price	Qty	Unit price
	1002200	3566837229542	TriVac 500 electric robot	1	653.00	4	620.35	12	587.70

MAINTENANCE ACCESSORIES



Code	EAN13	Description	Qty	Unit price	Qty	Unit price	Qté	Unit price	
BRUSHES									
1	9702700	3566837107734	Wall brush, 45cm	12	2.94	24	2.78	48	2.62
2	9703350	3566837130862	Water line brush	12	0.98	24	0.93	48	0.87
3	9703300	3566837130855	Corner vacuum brush	12	1.48	24	1.39	48	1.31
ROLLERS AND HOSES									
4	9703000	3566837132873	Floating hose roller	2	35.10	12	33.15	24	31.20
5	867350	3566837132880	Floating hose for above-ground pools, Ø 32 - Scored at 1.58m intervals - 15.80m dispensing box	1	36.40	14	34.58	28	32.76
	867450	3566837145439	Floating hose for above-ground pools, Ø 38 - Scored at 1.58m intervals - 15.80m dispensing box	1	38.20	14	36.29	28	34.38
	9703120	3566837145453	Floating hose, 7m - with two Ø 38mm end-pieces	4	23.04	24	21.76	48	20.48
	9703160	3566837145460	Floating hose, 10m - with two Ø 38mm end-pieces	4	28.35	18	26.78	36	25.20
	9703180	3566837145477	Floating hose, 12m - with two Ø 38mm end-pieces	4	33.75	18	31.88	36	30.00
	9703200	3566837130848	Floating hose, 15m - with two Ø 38mm end-pieces	4	41.76	14	39.44	28	37.12
6	9703950	3566837107819	Mini floating dispenser	24	1.53	48	1.45	96	1.36
7	9703900	3566837130817	Floating dispenser for 200g tablet	12	3.06	48	2.89	96	2.72
8	9704000	3566837130817	Skimmer adaptor for cleaner	24	1.94	48	1.84	96	1.73



REPAIR KIT

Code	EAN13	Description	Qty	Unit price	Qty	Unit price	Qty	Unit price
9703450	3566837107765	Liner repair kit	12	1.60	24	1.51	48	1.42

TEST KITS AND REFILLS

Code	EAN13	Description	Qty	Unit price	Qty	Unit price	Qty	Unit price	
9	9703800	3566837107796	Cl - pH kit refill, Duo Test (Ort.)	24	3.20	48	3.03	96	2.85
10	9703850	3566837107802	Cl - pH kit refill, Duo Test (Ort.)	24	1.24	48	1.17	96	1.10



MAINTENANCE ACCESSORIES



	Code	EAN13	Description	Qty	Unit price	Qty	Unit price	Qty	Unit price
SKIMMERS									
1	9703100	3566837107758	Hand skimmer	12	1.97	24	1.86	48	1.75
2	9702650	3566837107727	Leaf rake	12	2.90	24	2.74	48	2.58
3	9703150	3566837130824	Hand skimmer with 1.30m pole	12	3.93	24	3.71	48	3.50
TELESCOPIC POLES									
4	9702950	3566837130800	Telescopic pole, 100-300	20	10.62	40	10.03	80	9.44
	9702900	3566837107741	Telescopic pole, 180-360	20	12.51	40	11.82	80	11.12
	9702750	3566837130794	Telescopic pole, 240-480	20	14.76	40	13.94	80	13.12
VACUUMS & VACUUM HEADS									
5	9702500	3566837107710	Half moon vacuum head	12	3.67	24	3.47	48	3.26
6	9702150	3566837130770	Standard triangular vacuum head	6	6.21	12	5.87	24	5.52
7	9702400	3566837130787	Concrete vacuum head 8 wheels + brushes	12	10.44	24	9.86	48	9.28
8	9702210	3566837131272	Venturii only, may be mounted on the vacuum head	12	3.38	24	3.19	48	3.00

THERMOMETERS



	Code	EAN13	Description	Qty	Unit price	Qty	Unit price	Qty	Unit price
9	9703600	3566837130831	Floating thermometer, various animals, set of 12	1	25,60	2	24,32	4	23,04
10	9703650	3566837107772	Universal thermometer	24	0,93	48	0,88	96	0,82

FOOT BATH



	Code	EAN13	Description	Qty	Unit price	Qty	Unit price	Qty	Unit price
	9704100	3566837130886	Foot bath	12	4.20	24	3.97	48	3.74



04

BWT myPOOL Custom orders

AUTOMATIC COVERS	52
SURFACE AREA CALCULATIONS	53
AUTOMATIC COVERS	54
BUBBLE COVERS	56
BUBBLE COVERS FOR WOODEN POOLS	58
UNDERLAY	59
WINTER AND SAFETY COVERS	60
WINTER COVERS	63
BAR COVERS	64
BAR COVERS FOR WOODEN POOLS	65
0.75MM LINERS	66
0.75MM LINERS FOR WOODEN POOLS	68
0.50MM LINERS FOR WOODEN POOLS	69
COMPATIBLE LINERS	70
LINER ACCESSORIES	71



SAFETY ASSURED

The P-HS E automatic cover is the best means of preventing accidental falls into your pool. This cover complies with the French safety standard NF P90-308 and allows you to enjoy your pool with complete peace of mind.

TEMPERATE WATER

The P-HS E automatic cover shelters your pool against cool nights and cold gusting winds. You can begin your pool season in early spring and extend it into late Indian summers.

PURE WATER

The P-HS E automatic cover inhibits photosynthesis and the growth of microscopic algae. Cleaner, your water requires less filtration and a smaller quantity of chemicals.

A SIMPLE, WELL DESIGNED COVER

The P-HS E automatic covers are manufactured with all the know-how and professionalism expected of a market leader.

EXCLUSIVE ANTI-TILT MECHANISM

The P-HS E automatic cover is fitted with a slat hinge mechanism that has the smallest bending angle available on the market. This confers an increased load bearing capacity on the cover and therefore increased safety in the event of a fall onto the cover.



BECOME AN ECOCITIZEN

By keeping your pool clean and reducing filtration time, the P-HS-E automatic cover saves on energy and on pool chemicals.

Because the P-HS-E automatic cover reduces the quantity of water treatment products necessary, it lessens your pool's ecological impact on the environment.

Lastly, as part of its overall environmental design, the PVC that makes up your cover can be recycled. With the P-HS-E automatic cover, you get cutting edge technology and reduce your environmental foot print.



INFOS

Winter and summer covers are invoiced at a price per m² applied to a surface area calculated as described below

The surface area is calculated based on pool dimensions and the shape of the pool.

Steps and cut-outs are invoiced separately according to the fixed prices listed on the following pages.

Given that covers shrink by 1% during the first weeks following installation, they are made slightly larger than the pool.

Simple shape

A simple shape is a perfectly symmetrical square or rectangle. The calculation formulae apply with no surcharge..

Surface area = L x W

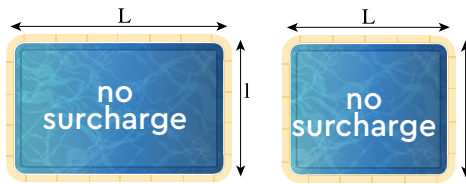

Geometric shape

A geometric shape is a perfectly symmetrical shape that may include rounded corners, re-entrant corners and truncated corners that can be traced with a ruler or a compass, without any need for triangulation (point coordinates).

In the case of a geometric shape, a surcharge of 10% is applied to the surface area calculated by our design office.

The price of the geometrically shaped winter or summer cover is then calculated by multiplying the surface area by the price per m² listed on the following pages..

Surface area = 1.10 x (L x W)

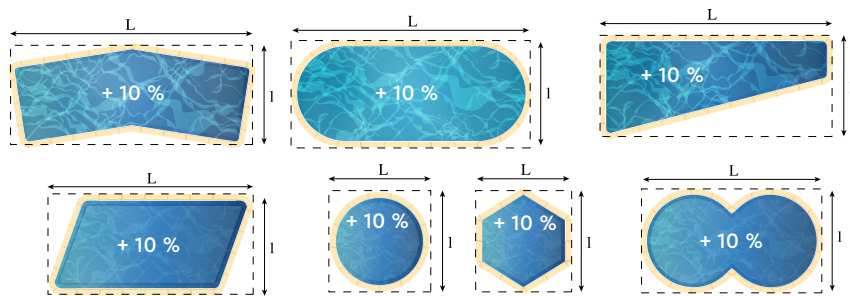

PRICE CALCULATION

Price = Surface area x Price per m²

In the case of soft covers, do not forget to add the following overlaps to the length and width measurement:

0.40 m for bar covers (that is 0.20 m around the periphery of the pool),

0.70 m for an extruded strip and double eyelet finish (that is 0.35 m around the periphery of the pool).



P-HS E MECHANICAL ASSEMBLIES - SLAT COVER APRONS - STEPS AND FASTENERS 

STEPPED FINISH

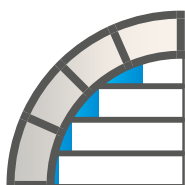

STEPS



P-HS E FASTENERS

The P-HS E fasteners are colour matched to the liner.



WHITE

BEIGE

GREY

LIGHT
BLUE

DARK
BLUE

GREEN

INFOS



The French safety standard NF P 90-308 prohibits an uncovered gap of more than 250mm. In the case of an order for a stepped finish, if a gap wider than 250mm is noted, the finish in the effected area will automatically shaped silicon.

The BWT MyPOOL automatic cover comprises the mechanical assembly, the slat cover apron and the cover fasteners. Transport to your BWT agency is included in the price. The maximum size of a P-HS E automatic cover is 5.09 × 12metres.

THE VARIOUS COMPONENTS MAY NOT BE ORDERED SEPARATELY.

Code	EAN13	Description	Qty	Unit price
MECHANICAL ASSEMBLY				
34205000	3566837156176	P-HS E mechanical assembly <3.10m	1	1,960.00
34205100	3566837155919	P-HS E mechanical assembly <4.10m	1	2,039.00
34205300	3566837155926	P-HS E mechanical assembly <5.10m	1	2,119.00
SLAT COVER APRONS				
34000300	3566837155902	P-HS E slat cover apron. white per m ²	1	33.00
34000500	3566837156152	P-HS E slat cover apron. beige per m ²	1	35.70
34000800	3566837156145	P-HS E slat cover apron. grey per m ²	1	35.70
34002600	3566837157012	P-HS E slat cover stepped finish	1	2.21
ROMAN STEP. STEPPED FINISH				
32104309	3566837209070	P-HS E roman step. stepped finish. white	1	463.00
32104509	3566837209063	P-HS E roman step. stepped finish. beige	1	470.00
32104809	3566837209056	P-HS E roman step. stepped finish. grey	1	470.00
STRAIGHT STEP. STEPPED FINISH				
32101309	3566837209100	P-HS E straight step. stepped finish. white	1	327.00
32101509	3566837209094	P-HS E straight step. stepped finish. beige	1	332.00
32101809	3566837209087	P-HS E straight step. stepped finish. grey	1	332.00
MISC STEP. STEPPED FINISH				
32107309	3566837209049	P-HS E misc step. stepped finish. white	1	467.00
32107509	3566837209032	P-HS E misc step. stepped finish. beige	1	474.00
32107809	3566837209025	P-HS E misc step. stepped finish. grey	1	474.00
WALL MOUNTED FASTENERS				
34800319	3566837155599	P-HS E wall mounted fastener. white	1	12.40
34800519	3566837155605	P-HS E wall mounted fastener. beige	1	12.40
34800819	3566837155612	P-HS E wall mounted fastener. grey	1	12.40
34800119	3566837156725	P-HS E wall mounted fastener. light blue	1	12.30
34800219	3566837156732	P-HS E wall mounted fastener. dark blue	1	12.30
34800419	3566837156749	P-HS E wall mounted fastener. green	1	12.30

ABOVE-GROUND AUTOMATIC COVER FOR WOODEN POOLS, WHITE 

INFOS

If the pool is fitted with an automatic cover, the ladder will need to be pulled up each time the cover is deployed.
On pools fitted with a peripheral deck at the same height as the coping, installation of a hinged hand rail (60223009) will avoid the need to remove the ladder.

Code	EAN13	Description	Qty	Unit price
1 ABOVE-GROUND AUTOMATIC COVER FOR WOODEN POOLS, WHITE				
34820300	3566837107246	P-HS E automatic cover, rect 6×3, white	1	2,623.00
34822300	3566837127558	P-HS E automatic cover, rect 9×3, white	1	2,918.00
34821300	3566837107253	P-HS E automatic cover, rect 8×4, white	1	3,134.00
34824300	3566837127589	P-HS E automatic cover, rect 12×3, white	1	3,213.00
34825300	3566837127619	P-HS E automatic cover, rect 12×4, white	1	3,660.00
34823300	3566837107260	P-HS E automatic cover, rect 10×5, white	1	3,800.00
2 ABOVE-GROUND AUTOMATIC COVER FOR WOODEN POOLS, GREY				
34820800	3566837107277	P-HS E automatic cover, rect 6×3, grey	1	2,648.00
34822800	3566837127572	P-HS E automatic cover, rect 9×3, grey	1	2,961.00
34821800	3566837107284	P-HS E automatic cover, rect 8×4, grey	1	3,183.00
34824800	3566837127602	P-HS E automatic cover, rect 12×3, grey	1	3,272.00
34825800	3566837127633	P-HS E automatic cover, rect 12×4, grey	1	3,734.00
34823800	3566837107291	P-HS E automatic cover, rect 10×5, grey	1	3,875.00
3 ABOVE-GROUND AUTOMATIC COVER FOR WOODEN POOLS, BEIGE				
34820500	3566837107307	P-HS E automatic cover, rect 6×3, beige	1	2,652.00
34822500	3566837127565	P-HS E automatic cover, rect 9×3, beige	1	2,964.00
34821500	3566837107314	P-HS E automatic cover, rect 8×4, beige	1	3,188.00
34824500	3566837127596	P-HS E automatic cover, rect 12×3, beige	1	3,274.00
34825500	3566837127626	P-HS E automatic cover, rect 12×4, beige	1	3,738.00
34823500	3566837107321	P-HS E automatic cover, rect 10×5, beige	1	3,882.00

DELIVERY OF P-HS E AUTOMATIC COVERS

Code	Description	Qty	Unit price
32900000	P-HS E automatic cover transport costs < 3.10 m, delivery to the installer, no appointment, no forklift	1	POA
32900100	P-HS E automatic cover transport costs < 4.10 m, delivery to the installer, no appointment, no forklift	1	POA
32900300	P-HS E automatic cover transport costs < 5.10 m, delivery to the installer, no appointment, no forklift	1	POA
32902000	P-HS E automatic cover transport costs < 3.10 m, delivery by appointment, with a forklift	1	POA
32902100	P-HS E automatic cover transport costs < 4.10 m, delivery by appointment, with a forklift	1	POA
32902300	P-HS E automatic cover transport costs < 5.10 m, delivery by appointment, with a forklift	1	POA

Transport costs are quoted net of any discount.



ISOTHERMAL, BUBBLE, SUMMER COVERS

The classic isothermal cover, keeps your pool water clean and warm.

PROTECT YOUR POOL WATER

The 300/400 bubble cover keeps the pool water warm by protecting it against gusts of wind and chilly nights.

HARD WEARING AND DURABLE

This 300/ 400 bubble cover is made of anti UV treated alveolar polyethylene 300 or 400 microns thick. It is hemmed across each width and edged down each length to protect it from friction where it touches the pool wall.

ECONOMICAL

The cover prevents evaporation. A must for indoor pools, and even more important for outdoor pools as the even higher rate of evaporation is even more costly in terms of water and pool chemicals.

TOUGH

The cover is solidly hemmed across the width to withstand the tensile stress exerted by the roller straps.

In addition, the cover features an eyelet at approx 50 cm intervals on the roller side as well as an eyelet in each corner on the side opposite the roller.

BUBBLE COVERS - CUSTOM MADE

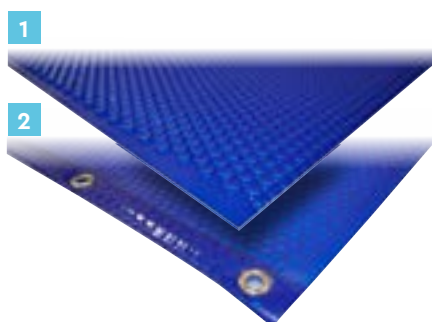

TECHNICAL DATA:

- » Ultrasonically welded, lengthwise
- » Strip width is 2 metres, strips 1 m wide may be welded on to create 'odd' widths,
- » The roll may feature one or two transversal weld seams.

INFOS For surface area calculation, see page 53

Code	EAN13	Description	Qty	Unit price
1 BUBBLE COVERS, UNHEMMED, NO EYELETS				
2067109	3566837157913	P-NB-300 bubble cover, blue	1	4.52
2037109	3566837157920	P-NB-400 bubble cover, blue	1	5.60
2 STANDARD FINISH, HEMMED ACROSS EACH WIDTH AND HEMMED DOWN EACH LENGTH				
2065109	3566837157906	P-O-300 bubble cover, blue	1	5.10
2035109	3566837157944	P-O-400 bubble cover, blue	1	6.20

OPTIONS FOR CUSTOM-MADE BUBBLE COVERS

STEPS

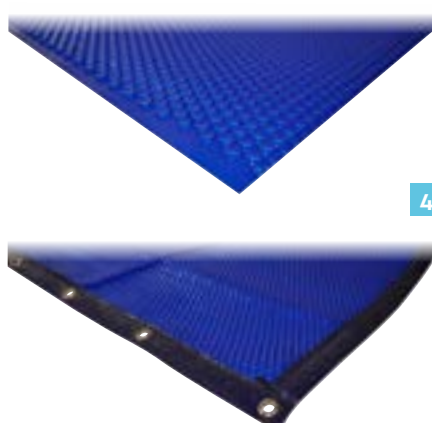

Code	EAN13	Description	Qty	Unit price
2035999	3566837157937	P bubble cover ladder cut-out	1	38.20
3 BUBBLE COVERS. UNHEMMED				
2250929	3566837158033	Straight steps /Bubble cover P-NB-300. blue	1	21.10
2260929	3566837157999	Roman steps /Bubble cover P-NB-300. blue	1	34.80
2280929	3566837157951	Misc steps /Bubble cover P-NB-300. blue	1	34.80
2250829	3566837158057	Straight steps /Bubble cover P-NB-400. blue	1	25.70
2260829	3566837158019	Roman steps /Bubble cover P-NB-400. blue	1	43.30
2280829	3566837157975	Misc steps /Bubble cover P-NB-400. blue	1	43.30
4 BUBBLE COVER. REINFORCED BAND FINISH				
2250919	3566837158040	Straight steps /Bubble cover P-C-300. blue	1	54.50
2260919	3566837158002	Roman steps /Bubble cover P-C-300. blue	1	67.90
2280919	3566837157968	Misc steps /Bubble cover P-C-300. blue	1	67.90
2250819	3566837158064	Straight steps /Bubble cover P-C-400. blue	1	59.20
2260819	3566837158026	Roman steps /Bubble cover P-C-400. blue	1	76.30
2280819	3566837157982	Misc steps /Bubble cover P-C-400. blue	1	76.40

BUBBLE COVER, IN ROLLS

» Although the Silver version of the cover is completely opaque, the cover does not look dark, its aesthetic appeal is maintained.

Code	EAN13	Description	Qty	Unit price	Qty	Unit price	Qty	Unit price
BUBBLE COVER, BLUE								
2039000	3566835446057	P-400 bubble cover, blue – 50 × 3m	1	733.00	3	696.35	8	659.70
2039100	3566835411635	P-400 bubble cover, blue – 50 × 4m	1	892.00	3	847.40	8	802.80
2039300	3566835411628	P-400 bubble cover, blue – 50 × 5m	1	1,204.00	3	1,143.80	8	1,083.60
2039500	3566835411666	P-400 bubble cover, blue – 50 × 6m	1	1,372.00	3	1,303.40	8	1,234.80
2039700	3566835454625	P-400 bubble cover, blue – 50 × 7m	1	1,694.00	3	1,609.30	8	1,524.60
COUVERTURES À BULLES SILVER								
2029000	3566835454571	P-400 bubble cover, silver – 50 × 3m	1	794.00	3	754.30	8	714.60
2029100	3566835454588	P-400 bubble cover, silver – 50 × 4m	1	973.00	3	924.35	8	875.70
2029300	3566835454595	P-400 bubble cover, silver – 50 × 5m	1	1,306.00	3	1,240.70	8	1,175.40
2029500	3566835454601	P-400 bubble cover, silver – 50 × 6m	1	1,494.00	3	1,419.30	8	1,344.60
2029700	3566835454618	P-400 bubble cover, silver – 50 × 7m	1	1,835.00	3	1,743.25	8	1,651.50

BUBBLE COVERS - ROUND

TECHNICAL DATA: :

- » Ultrasonically welded, not hemmed, no eyelets
- » Material: Polyethylene.



Code	EAN13	Description	Qty	Unit price	Qty	Unit price	Qty	Unit price
2041030	3566831130929	P-180 bubble cover. round. diameter 2.44m	1	20.50	8	19.48	24	18.45
2041130	3566835420262	P-180 bubble cover. round. diameter 3.05m	1	27.50	8	26.13	24	24.75
2041230	3566835420279	P-180 bubble cover. round. diameter 3.66m	1	39.10	8	37.15	24	35.19
2041330	3566835009306	P-180 bubble cover. round. diameter 3.97m	1	48.10	8	45.70	24	43.29
2041430	3566835420286	P-180 bubble cover. round. diameter 4.58m	1	62.40	8	59.28	24	56.16
2061630	3566835435495	P-280 bubble cover. round. diameter 5.49m	1	98.70	8	93.77	24	88.83
2061830	3566835435396	P-280 bubble cover. round. diameter 6.40m	1	134.30	8	127.59	24	120.87
2061930	3566835435402	P-280 bubble cover. round. diameter 7.32m	1	172.60	8	163.97	24	155.34

BUBBLE COVERS - OVAL

TECHNICAL DATA: :

- » Ultrasonically welded, not hemmed, no eyelets
- » Material: Polyethylene.



Code	EAN13	Description	Qty	Unit price	Qty	Unit price	Qty	Unit price
2061131	3566835435334	P-280 bubble cover. oval. 5.49 × 3.66m	1	73.50	8	69.83	24	66.15
2061331	3566835435341	P-280 bubble cover. oval. 7.32 × 3.66m	1	99.60	8	94.62	24	89.64
2061431	3566835435358	P-280 bubble cover. oval. 8.24 × 4.58m	1	138.00	8	131.10	24	124.20
2061531	3566835435365	P-280 bubble cover. oval. 9.15 × 4.58m	1	156.10	8	148.30	24	140.49
2061631	3566835435372	P-280 bubble cover. oval. 10.00 × 5.49m	1	197.30	8	187.44	24	177.57
2061731	3566835435389	P-280 bubble cover. oval. 12.00 × 5.49m	1	245.00	8	232.75	24	220.50



BUBBLE COVERS - WOODEN POOLS



ECONOMICAL

The cover prevents evaporation. A must for indoor pools, and even more important for outdoor pools as the even higher rate of evaporation is even more costly in terms of water and pool chemicals.

HARD WEARING AND DURABLE

This bubble cover is made of anti UV treated alveolar polyethylene 280 microns thick. It is hemmed across each width and edged down each length to protect it from friction where it touches the pool wall.

TOUGH

The cover is solidly hemmed across the width to withstand the tensile stress exerted by the roller straps. In addition, the cover features an eyelet at approx 50 cm intervals on the roller side as well as an eyelet in each corner on the side opposite the roller.



TECHNICAL DATA::

- » Polyethylene 280 µ.
- » Edged down each length.
- » Hemmed across each width.

Code	EAN13	Description	Qty	Unit price	Qty	Unit price	Qty	Unit price
2061252	3566837123734	P-280 bubble cover, wooden pools, H410	1	65.50	4	62.23	12	58.95
2061256	3566835418467	P-280 bubble cover, wooden pools, 414	1	80.50	4	76.48	12	72.45
2061456	3566835418450	P-280 bubble cover, wooden pools, 505	1	101.50	4	96.43	12	91.35
2061258	3566837187873	P-280 bubble cover, wooden pools, +450	1	71.90	4	68.31	12	64.71
2061356	3566837034320	P-280 bubble cover, wooden pools, +460	1	72.50	4	68.88	12	65.25
2061458	3566837123703	P-280 bubble cover, wooden pools, +510	1	77.00	4	73.15	12	69.30
2061556	3566837029548	P-280 bubble cover, wooden pools, +540	1	85.70	4	81.42	12	77.13
2061856	3566837034344	P-280 bubble cover, wooden pools, +610	1	99.00	4	94.05	12	89.10
2061756	3566835444282	P-280 bubble cover, wooden pools, +640	1	100.60	4	95.57	12	90.54
2061956	3566835444299	P-280 bubble cover, wooden pools, +840	1	148.40	4	140.98	12	133.56
2061250	3566837123666	P-280 bubble cover, wooden pools, 3x3	1	49.90	4	47.41	12	44.91
2061350	3566837123727	P-280 bubble cover, wooden pools, 4x4	1	67.00	4	63.65	12	60.30
2061550	3566837123710	P-280 bubble cover, wooden pools, 5x5	1	99.20	4	94.24	12	89.28
2061155	3566837123741	P-280 bubble cover, wooden pools, 4.5x3	1	61.20	4	58.14	12	55.08
2061455	3566835405504	P-280 bubble cover, wooden pools, 6x3	1	75.40	4	71.63	12	67.86
2061655	3566835405559	P-280 bubble cover, wooden pools, 8x4	1	116.00	4	110.20	12	104.40
2061355	3566837123758	P-280 bubble cover, wooden pools, 9x3	1	108.00	4	102.60	12	97.20
2061955	3566837078409	P-280 bubble cover, wooden pools, 10x5	1	199.20	4	189.24	12	179.28
2061555	3566835415572	P-280 bubble cover, wooden pools, 12x3	1	131.50	4	124.93	12	118.35
2061055	3566837235406	P-280 bubble cover, Pool'n Box pool, 5x2	1	49.90	4	47.41	12	44.91

ROLLER FOR ISOTHERMAL COVERS



HARMONIOUS SHAPE FOR SEAMLESS INTEGRATION

TECHNICAL DATA: :

- » Straight posts made of 304 L stainless steel, fastened to the ground using the two 304L stainless steel flanges (delivered with all screws and washers necessary).
- » Axle height: 350mm.
- » Axle diameter: 95mm.
- » Delivered with 15 bungee straps.
- » This model is designed for installation on the coping, directly over the pool wall.

Code	EAN13	Description	Qty	Unit price	Qty	Unit price	Qty	Unit price
1868201	3566837172640	BWT MyPOOL roller for Octo/ Octo+ wooden pools	1	316.00	6	300.20	12	284.40
1868305	3566835448594	BWT MyPOOL roller for rectangular wooden pools 3.5 – 5.0m	1	387.00	6	367.65	12	348.30

UNDERLAY FOR WOODEN POOLS - HDPE 200 G/M²

Code	EAN13	Description	Qty	Unit price	Qty	Unit price	Qty	Unit price		
5491252	3566837122102	Underlay P-160. wooden pool. Hexa 410	1	34.70	18	32.97	36	31.23		
5495257	3566835499107	Underlay P-160. wooden pool. octo 360	1	35.70	18	33.92	36	32.13		
5495357	3566835474906	Underlay P-160. wooden pool. octo 414	1	42.20	18	40.09	36	37.98		
5495457	3566835474913	Underlay P-160. wooden pool. octo 505	1	63.30	18	60.14	36	56.97		
5491258	3566837175436	Underlay P-160. wooden pool. octo +450	1	46.00	18	43.70	36	41.40		
5491357	3566837023034	Underlay P-160. wooden pool. octo +460	1	46.60	18	44.27	36	41.94		
5495458	3566837122119	Underlay P-160. wooden pool. octo +510	1	48.50	18	46.08	36	43.65		
5491557	3566835530855	Underlay P-160. wooden pool. +540	1	51.40	18	48.83	36	46.26		
5491757	3566835530862	Underlay P-160. wooden pool. +610	1	62.00	18	58.90	36	55.80		
5495757	3566835474883	Underlay P-160. wooden pool. octo +640	1	65.60	18	62.32	36	59.04		
5495857	3566835474890	Underlay P-160. wooden pool. octo +840	1	109.30	18	103.84	36	98.37		
5491250	3566837123291	Underlay P-160. wooden pool. 3 × 3m	1	36.00	18	34.20	36	32.40		
5491350	3566837123307	Underlay P-160. wooden pool. 4 × 4m	1	62.30	18	59.19	36	56.07		
5491550	3566837123260	Underlay P-160. wooden pool. 5 × 5m	1	86.80	18	82.46	36	78.12		
5491154	3566837123253	Underlay P-160. wooden pool. 4.5 × 3m	1	49.40	18	46.93	36	44.46		
5491254	3566837025403	Underlay P-160. wooden pool. 6 × 3m	1	68.50	18	65.08	36	61.65		
5491554	3566837063757	Underlay P-160. wooden pool. 8 × 4m	1	110.90	18	105.36	36	99.81		
5491354	3566837123277	Underlay P-160. wooden pool. 9 × 3m	1	88.80	18	84.36	36	79.92		
5491854	3566837063764	Underlay P-160. wooden pool. 10 × 5m	1	161.90	18	153.81	36	145.71		
5491454	3566837123284	Underlay P-160. wooden pool. 12 × 3m	1	115.60	18	109.82	36	104.04		
5491754	3566837123314	Underlay P-160. wooden pool. 12 × 4m	1	161.70	18	153.62	36	145.53		
5491059	3566837179342	Underlay for Pistoche 2×2m	Page 82							
5491155	3566837175092	Underlay P-160. Urban pool. 3.6 × 6m	1	33.60	18	31.92	36	30.24		
5491055	3566837175108	Underlay P-160. Urban pool. 5.5 × 2m	1	46.70	18	44.37	36	42.03		
5491255	3566837224257	Underlay P-160, Pool'N box pool, 5 × 2 m	1	38.90	18	36.96	36	35.01		

UNDERLAY FOR SHEET METAL WALL POOLS - HDPE 200 G/M²

Code	EAN13	Description	Qty	Unit price	Qty	Unit price	Qty	Unit price
5491300	3566831131551	Underlay / Round pool. diameter 2.44m	1	25.10	18	23.85	36	22.59
5491301	3566831131568	Underlay / Round pool. diameter 3.05m	1	38.40	18	36.48	36	34.56
5491302	3566831131575	Underlay / Round pool. diameter 3.66m	1	51.70	18	49.12	36	46.53
5491303	3566835013723	Underlay / Round pool. diameter 4.05m	1	60.20	18	57.19	36	54.18
5491304	3566831131582	Underlay / Round pool. diameter 4.58m	1	77.40	18	73.53	36	69.66
5491306	3566831131599	Underlay / Round pool. diameter 5.49m	1	113.80	18	108.11	36	102.42
5491308	3566831131605	Underlay / Round pool. diameter 6.40m	1	143.30	18	136.14	36	128.97
5491309	3566831131612	Underlay / Round pool. diameter 7.32m	1	184.80	18	175.56	36	166.32
5491310	3566831131629	Underlay / Oval pool. 5.03 × 3.20m	1	66.20	18	62.89	36	59.58
5491311	3566831131636	Underlay / Oval pool. 5.49 × 3.66m	1	82.90	18	78.76	36	74.61
5491312	3566831131643	Underlay / Oval pool. 6.10 × 3.66m	1	93.00	18	88.35	36	83.70
5491313	3566831131650	Underlay / Oval pool. 7.32 × 3.66m	1	114.10	18	108.40	36	102.69
5491314	3566831131667	Underlay / Oval pool. 8.24 × 4.58m	1	152.30	18	144.69	36	137.07
5491315	3566831131674	Underlay / Oval pool. 9.15 × 4.58m	1	170.80	18	162.26	36	153.72
5491316	3566831131681	Underlay / Oval pool. 10.00 × 5.49m	1	222.00	18	210.90	36	199.80
5491317	3566831131698	Underlay / Oval pool. 12.00 × 5.49m	1	270.00	18	256.50	36	243.00



P-PB-580 WOODEN POOL WINTER AND SAFETY COVERS 

TECHNICAL DATA: :

- » Cover made of PVC coated fabric (580 g/m²). The top side is grey while the underside is beige.
- » The cover overlaps the entire periphery of the pool structure (coping included) by 10 cm.
- » Fastened in position with individual bungee straps and stainless steel hooks that are fixed under the coping,
- » Complies with the French standard NF P90-308.



Code	EAN13	Description	Qty	Unit price	Qty	Unit price	Qty	Unit price	
2183252	3566837123598	P-PB 580 winter safety cover. grey. H410	1	230.00	4	218.50	8	207.00	
2183256	3566837070366	P-PB 580 winter safety cover. grey. 414	1	241.00	4	228.95	8	216.90	
2183456	3566837070373	P-PB 580 winter safety cover. grey. 505	1	347.00	4	329.65	8	312.30	
2183258	3566837187880	P-PB 580 winter safety cover. grey. +450	1	273.00	4	259.35	8	245.70	
2183356	3566837070311	P-PB 580 winter safety cover. grey. +460	1	273.00	4	259.35	8	245.70	
2183458	3566837123550	P-PB 580 winter safety cover. grey. +510	1	283.00	4	268.85	8	254.70	
2183556	3566837070328	P-PB 580 winter safety cover. grey. +540	1	289.00	4	274.55	8	260.10	
2183656	3566837073510	P-PB 580 winter safety cover. grey. +610	1	330.00	4	313.50	8	297.00	
1	2183756	3566837070335	P-PB 580 winter safety cover. grey. +640	1	354.00	4	336.30	8	318.60
	2183956	3566837070342	P-PB 580 winter safety cover. grey. +840	1	582.00	4	552.90	8	523.80
	2183250	3566837123581	P-PB 580 winter safety cover. grey. 3x3	1	230.00	4	218.50	8	207.00
2	2183350	3566837123604	P-PB 580 winter safety cover. grey. 4x4	1	306.00	4	290.70	8	275.40
	2183550	3566837123574	P-PB 580 winter safety cover. grey. 5x5	1	465.00	4	441.75	8	418.50
	2183154	3566837123628	P-PB 580 winter safety cover. grey. 4.5x3	1	298.00	4	283.10	8	268.20
3	2183254	3566837070380	P-PB 580 winter safety cover. grey. 6x3	1	330.00	4	313.50	8	297.00
	2183654	3566837070397	P-PB 580 winter safety cover. grey. 8x4	1	512.00	4	486.40	8	460.80
	2183354	3566837123611	P-PB 580 winter safety cover. grey. 9x3	1	487.00	4	462.65	8	438.30
	2183954	3566837070359	P-PB 580 winter safety cover. grey. 10x5	1	768.00	4	729.60	8	691.20
	2183454	3566837123543	P-PB 580 winter safety cover. grey. 12x3	1	556.00	4	528.20	8	500.40
	2183750	3566837123567	P-PB 580 winter safety cover. grey. 12x4	1	701.00	4	665.95	8	630.90
	2183054	3566837235390	P-PB 580 winter safety cover, grey, Pool'n Box	1	298.40	4	283.48	8	268.56

POOL SHAPE/ COVER CORRESPONDENCE

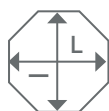

OCTAGONAL POOLS

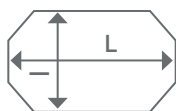

ELONGATED OCTAGONAL POOLS

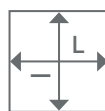

SQUARE POOLS

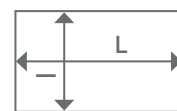

RECTANGULAR POOLS

Code	Description	Cover shape	Max pool length, coping included (m)	Max pool width, coping included (m)	Cover length (m)	Cover width (m)
2183252	P-PB 580 winter safety cover, grey, H410	Hexagonal	4.19	3.63	4.39	3.83
2183256	P-PB 580 winter safety cover, grey, 440	Octagonal	4.03	4.03	4.23	4.23
2183456	P-PB 580 winter safety cover, grey, 530	Octagonal	4.88	4.88	5.08	5.08
2183258	P-PB 580 winter safety cover, grey, +450	Elongated octagonal	4.52	3.13	4.72	3.33
2183356	P-PB 580 winter safety cover, grey, +460	Elongated octagonal	4.81	3.31	5.01	3.51
2183458	P-PB 580 winter safety cover, grey, +510	Elongated octagonal	4.95	3.45	5.15	3.65
2183556	P-PB 580 winter safety cover, grey, +540	Elongated octagonal	5.23	3.13	5.43	3.33
2183656	P-PB 580 winter safety cover, grey, +610	Elongated octagonal	6.13	4.03	6.33	4.23
2183756	P-PB 580 winter safety cover, grey, +640	Elongated octagonal	6.43	4.03	6.63	4.23
2183956	P-PB 580 winter safety cover, grey, +840	Elongated octagonal	8.42	4.88	8.62	5.08
2183250	P-PB 580 winter safety cover, grey, 3x3	Square	3.53	3.53	3.73	3.73
2183350	P-PB 580 winter safety cover, grey, 4x4	Square	4.53	4.53	4.73	4.73
2183550	P-PB 580 winter safety cover, grey, 5x5	Square	5.53	5.53	5.73	5.73
2183154	P-PB 580 winter safety cover, grey, 4.5x3	Rectangle	5.03	3.53	5.23	3.73
2183254	P-PB 580 winter safety cover, grey, 6x3	Rectangle	6.53	3.53	6.73	3.73
2183654	P-PB 580 winter safety cover, grey, 8x4	Rectangle	8.53	4.53	8.73	4.73
2183354	P-PB 580 winter safety cover, grey, 9x3	Rectangle	9.53	3.53	9.73	3.73
2183954	P-PB 580 winter safety cover, grey, 10x5	Rectangle	10.53	5.53	10.73	5.73
2183454	P-PB 580 winter safety cover, grey, 12x3	Rectangle	12.53	3.53	12.73	3.73
2183750	P-PB 580 winter safety cover, grey, 12x4	Rectangle	12.53	4.53	12.73	4.73
2183054	P-PB 580 winter safety cover, grey, Pool'n Box	Rectangle	6.10	2.37	6.30	2,57





CUSTOM MADE P-W 580 WINTER AND SAFETY COVERS



TECHNICAL DATA: :

- » The P-W 580 cover is made of opaque, PVC coated 580g reinforced woven polyester.
- » The surface in contact with the ground is beige coloured, to avoid the risk of staining,
- » Cleverly spaced perforations allow rain water to drain rapidly, preventing the formation of water pockets,
- » On pools that features steps and free form pools, additional perforations are made,
- » The PVC coating on the P-W 580 cover is treated to block UV, it is also resistant to chlorine,
- » The P-W 580 cover is edged with a continuous extruded snap rod designed to receive individual straps,
- » There is a 35 cm overlap around the periphery of the pool,
- » Colour: grey/ beige.



INFOS For surface area calculation, see page 53

Code	EAN13	Description	Qty	Unit price
8388009	3566837158149	P-W 580 winter safety cover, grey, per m ²	1	13,50

P-W-580 COVERS STEP PIECES AND LADDER CUT OUTS

INFOS Do not forget to indicate the side on which the roller is located. Include the ladder cut-out measurements when ordering the cover.

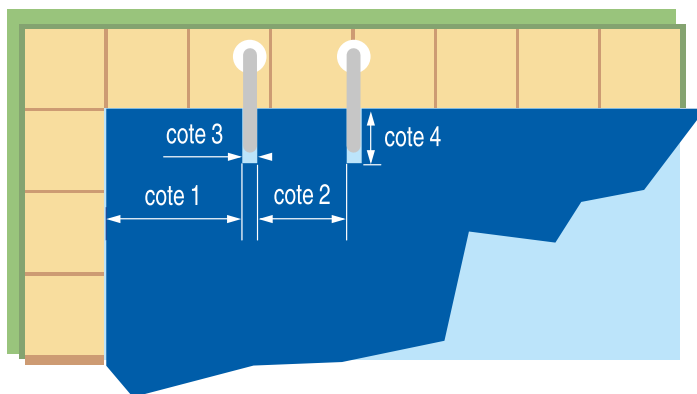

STEPS



Code	EAN13	Description	Qty	Unit price
2253809	3566837158187	P-W 580 straight step piece, grey	1	102.40
2263809	3566837158163	P-W 580 roman step piece, grey	1	160.50
2283809	3566837158132	P-W 580 misc step piece, grey	1	180.20
8329009	3566837159573	P-W 580 winter safety cover ladder cut-out	1	20.80

P-HS WINTER COVERS, ROUND OR OVAL 

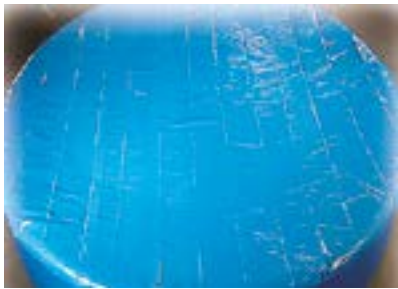

TECHNICAL DATA :

- » Ultrasonic assembly, fastened in place with a peripheral bungee strap, 20 cm overlap around the entire periphery of the pool structure.
- » Material: Woven polyethylene, 200 g.
- » Colour, blue, reversible Black.



Code	EAN13	Description	Qty	Unit price	Qty	Unit price	Qty	Unit price
2181030	3566831131063	P-HS 200 winter cover, round, 2.44m	1	33.90	4	32.21	12	30.51
2181130	3566831131070	P-HS 200 winter cover, round, 3.05m	1	46.90	4	44.56	12	42.21
2181230	3566835420323	P-HS 200 winter cover, round, 3.66m	1	63.40	4	60.23	12	57.06
2181330	3566835009665	P-HS 200 winter cover, round, 3.97m	1	73.40	4	69.73	12	66.06
2181430	3566835420330	P-HS 200 winter cover, round, 4.58m	1	92.20	4	87.59	12	82.98
2181630	3566835420347	P-HS 200 winter cover, round, 5.50m	1	126.10	4	119.80	12	113.49
2181830	3566831131124	P-HS 200 winter cover, round, 6.40m	1	166.90	4	158.56	12	150.21
2181930	3566831131131	P-HS 200 winter cover, round, 7.32m	1	216.00	4	205.20	12	194.40
2181031	3566831131148	P-HS 200 winter cover, oval, 5.03 × 3.20m	1	79.40	4	75.43	12	71.46
2181131	3566831131155	P-HS 200 winter cover, oval, 5.48 × 3.66m	1	95.70	4	90.92	12	86.13
2181331	3566835420354	P-HS 200 winter cover, oval, 7.32 × 3.66m	1	129.40	4	122.93	12	116.46
2181431	3566831131186	P-HS 200 winter cover, oval, 8.24 × 4.58m	1	170.70	4	162.17	12	153.63
2181531	3566835420361	P-HS 200 winter cover, oval, 9.15 × 4.58m	1	190.60	4	181.07	12	171.54
2181631	3566831131209	P-HS 200 winter cover, oval, 10.00 × 5.50m	1	242.00	4	229.90	12	217.80
2181731	3566831131216	P-HS 200 winter cover, oval, 12.00 × 5.50m	1	292.00	4	277.40	12	262.80

WINTER COVER ACCESSORIES



	Code	EAN13	Description	Qty	Unit price	Qty	Unit price	Qty	Unit price
1	2394025	3566837165512	Ø6 SS anchor bushing with plug + hole cap set of 25	1	33.70	4	32.02	12	30.33
2	2394026	3566837165505	Anchor bushing Ø 10 SS/alu	1	31.00	4	29.45	12	27.90
2	2394024	3566837212124	Anchor bushing Ø 12 SS/alu	1	37.60	4	35.72	12	33.84
3	2394027	3566837165543	Peg for wooden deck	1	161.90	4	153.81	12	145.71
4	2394028	3566837165499	Fastening hook/wooden pool with screws set of 25*	1	94.50	4	89.78	12	85.05
5	2394029	3566837165529	Beige bungee strap. 8mm per 100 m	1	75.20	4	71.44	12	67.68

*vertical fastener on the wooden pool wall



CUSTOM MADE BAR COVERS, P-580

TECHNICAL DATA: :

- » The P-580 bar cover is made of very hard wearing PVC coated polyester (580g/m²), treated to withstand U.V.
- » The material is unbroken where it passes under the bars to provide increased mechanical strength. Both sides of the cover are varnished to protect it from damage from chemical products, wear and abrasion.
- » Anodised aluminium bars strengthen and reinforce the cover,

- allowing it to bear the weight of a child falling onto it without sustaining any damage.
- » The flywheel or crank is included.
- » The overlap around the periphery of the pool is 20 cm.
- » Straps are held in position by D8 bushings (provided).



Code	EAN13	Description	Qty	Unit price
6316009	3566837159627	P-580 bar cover < 3.45 grey, with flywheel per m ²	1	35.00
6316209	3566837159696	P-580 bar cover < 4.45 grey, with flywheel per m ²	1	29.50
6316409	3566837159689	P-580 bar cover < 5.45 grey, with flywheel per m ²	1	28.50
6314009	3566837159634	P-580 bar cover < 3.45 grey, with hand crank per m ²	1	37.40
6314209	3566837159719	P-580 bar cover < 4.45 grey, with hand crank per m ²	1	30.50
6314409	3566837159702	P-580 bar cover < 5.45 grey, with hand crank per m ²	1	30.00

STEP PIECES FOR CUSTOM MADE P-580 BAR COVERS

Code	EAN13	Description	Qty	Unit price
6326009	3566837160012	P-580 step across the width. grey < 3.50 metres	1	210.00
6336009	3566837160043	P-580 step across the width. grey >= 3.50 metres	1	216.00
6366009	3566837160036	P-580 step down the length. grey < 3.50 metres	1	358.00
6376009	3566837159993	P-580 step down the length. grey >= 3.50 metres	1	396.00

FLYWHEEL AND CRANK FOR P-580 COVERS

INFO: The installation of a bar cover implies removal of the ladder each time the cover is deployed over the pool. If the pool is fitted with a peripheral deck the same height as the coping, installation of a hinged hand rail, art. no. 60223009 avoids the necessity to remove the ladder. The hinged hand-rail comprises a hand-rail and a plate that allows the ladder to pivot by 90°. Installation of this hand-rail requires a peripheral deck at least 400mm wide.

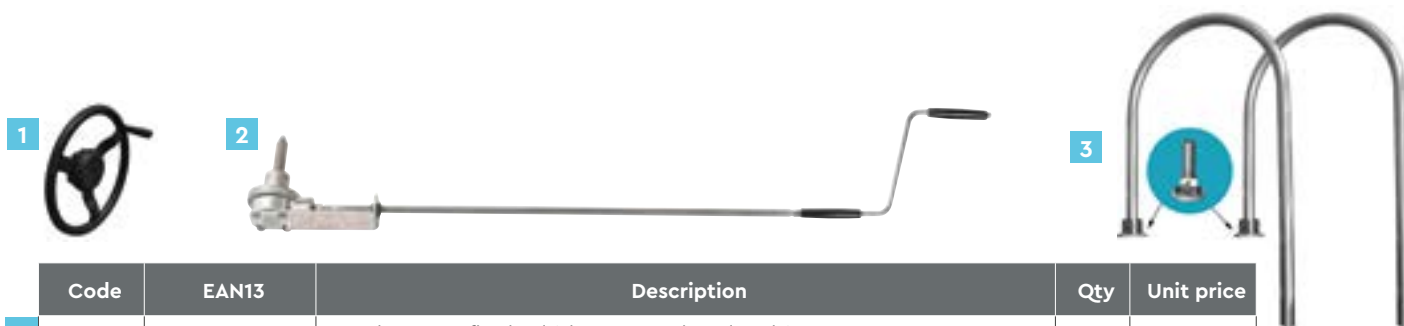

	Code	EAN13	Description	Qty	Unit price
1	6309059	3566837162009	P-580 bar cover flywheel (above ground pools only)	1	41.60
2	6309069	3566837159795	P-580 bar cover crank	1	76.60
3	60223009	3566837174941	BWT MyPOOL hinged hand rail/ Bar covers *	1	248.00

* Hinges must be fixed to the peripheral deck and not to the coping.

BAR COVER TRANSPORT COSTS

Code	EAN13	Description	Qty	Unit net price exVAT
6490100	3566835485506	Bar cover transports costs, delivery by appointment	1	216.00

Transport costs are quoted net of any discount.



THE BAR COVER IS EASY TO USE

- » To deploy the cover, simply pull on the central strap.
- » The cover is rolled up using a flywheel or a hand crank. No complicated mechanisms or risk of break down.

THE BAR COVER IS PRACTICAL

- » A single cover to install for years of care-free enjoyment. You escape the nuisance of seasonal cover changes and the drudgery: cleaning, folding and storing the cover removed unfolding and installation of the other cover. Choose comfort, choose a bar cover.

THE BAR COVER IS EASY TO CLEAN

- » With its two lacquered surfaces, the bar cover stays clean, it is easily washed down with a blast of water.

THE BAR COVER IS TOUGH

- » To increase the service life of the cover, the bars are made of natural anodised aluminium.

THE BAR COVER IS STRONG

- » The cover is made of hard wearing polyester (580g/m²), treated to withstand the effects of UV radiation.
- » To increase the mechanical strength of the cover, the cover fabric is not cut where it passes under the bars. Both surfaces of this resilient cover are lacquered to help withstand chemical attacks and the effects of wear and tear.
- » Straps are fastened to the pool wall using SS hooks (provided).



INFOS Handcrank included

BAR COVERS P-580 FOR WOODEN POOLS 

Code	EAN13	Description	Qty	Unit price	Qty	Unit price	Qty	Unit price
6304244	3566837148577	P-580 bar cover/ wooden pools. 410	1	531.00	4	504.45	8	477.90
6304146	3566837148591	P-580 bar cover/ wooden pools. 414	1	599.00	4	569.05	8	539.10
6304346	3566837148522	P-580 bar cover/ wooden pools. 505	1	796.00	4	756.20	8	716.40
6304547	3566837187866	P-580 bar cover/ wooden pools. +450	1	654.00	4	621.30	8	588.60
6304047	3566837148621	P-580 bar cover/ wooden pools. +460	1	656.00	4	623.20	8	590.40
6304247	3566837148553	P-580 bar cover/ wooden pools. +510	1	697.00	4	662.15	8	627.30
6304147	3566837148584	P-580 bar cover/ wooden pools. +540	1	748.00	4	710.60	8	673.20
6304347	3566837148508	P-580 bar cover/ wooden pools. +610	1	795.00	4	755.25	8	715.50
6304447	3566837146924	P-580 bar cover/ wooden pools. +640	1	830.00	4	788.50	8	747.00
6304747	3566837148447	P-580 bar cover/ wooden pools. +840	1	1,093.00	4	1,038.35	8	983.70
6304143	3566837148614	P-580 bar cover/ wooden pools. 3x3	1	586.00	4	556.70	8	527.40
6304343	3566837148546	P-580 bar cover/ wooden pools. 4x4	1	700.00	4	665.00	8	630.00
6304543	3566837148485	P-580 bar cover/ wooden pools. 5x5	1	998.00	4	948.10	8	898.20
6304145	3566837148607	P-580 bar cover/ wooden pools. 4.5x3	1	723.00	4	686.85	8	650.70
6304245	3566837148560	P-580 bar cover/ wooden pools. 6x3	1	802.00	4	761.90	8	721.80
6304645	3566837148478	P-580 bar cover/ wooden pools. 8x4	1	1,065.00	4	1,011.75	8	958.50
6304345	3566837148539	P-580 bar cover/ wooden pools. 9x3	1	1,033.00	4	981.35	8	929.70
6304945	3566837148454	P-580 bar cover/ wooden pools. 10x5	1	1,400.00	4	1,330.00	8	1,260.00
6304445	3566837148492	P-580 bar cover/ wooden pools. 12x3	1	1,250.00	4	1,187.50	8	1,125.00
6304745	3566837148461	P-580 bar cover/ wooden pools. 12x4	1	1,449.00	4	1,376.55	8	1,304.10
6304045	3566837235383	P-580 bar cover/ Pool'n Box	1	800.00	4	760.00	8	720.00



INFOS

HARPON LINER LOCK BEADING

(For pools of all types fitted with a Hung locking track)
The Harpon is the same colour as the liner.

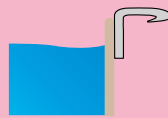

INFOS

LINER SURFACE AREA CALCULATIONS

Liner surface area calculations are shown on page 184

INFOS

LINER SURFACE AREA LESS THAN 60M²

If the surface area of P-75 liner is less than 60m², a surcharge of 10% will be applied to the total net surface area.

Price of a liner with a surface area less than 60m² = (TNSA* x 1.10) x price per m²

• TNSA = Total Net Surface Area



White



Light blue



Dark blue



Green



Beige



Grey

0.75MM LINERS - FLAT POOL FLOOR CONTOUR- RECTANGLE AND SQUARE ONLY

Code	EAN13	Description	Unit price
70220800	3566837156473	Liner P-75 rectangular, flat bottom, white, per m ²	9.20
70220810	3566837156398	Liner P-75 rectangular, flat bottom, light blue, per m ²	9.20
70220820	3566837156497	Liner P-75 rectangular, flat bottom, dark blue, per m ²	9.20
70220830	3566837156503	Liner P-75 rectangular, flat bottom, green, per m ²	9.20
70220840	3566837156510	Liner P-75 rectangular, flat bottom, beige, per m ²	9.20
70220860	3566837156527	Liner P-75 rectangular, flat bottom, grey, per m ²	9.20

0.75MM LINERS - OTHER POOL SHAPES

Code	EAN13	Description	Unit price
70221900	3566837156534	Liner P-75. non flat floor contour. white, per m ²	11.10
70221910	3566837156541	Liner P-75. non flat floor contour. light blue, per m ²	11.10
70221920	3566837156558	Liner P-75. non flat floor contour. dark blue, per m ²	11.10
70221930	3566837156480	Liner P-75. non flat floor contour. green, per m ²	11.10
70221940	3566837156466	Liner P-75. non flat floor contour. beige, per m ²	11.10
70221960	3566837156411	Liner P-75. non flat floor contour. grey, per m ²	11.10

STEP LINER PIECES

STEPS



Code	EAN13	Description	Unit price
CORNER STEP LINERS			
71222200	3566837209728	Corner step, liners P-75, white	294.00
71222210	3566837209735	Corner step, liners P-75, light blue	294.00
71222220	3566837209742	Corner step, liners P-75, dark blue	294.00
71222230	3566837209759	Corner step, liners P-75, green	294.00
71222240	3566837209766	Corner step, liners P-75, beige	294.00
71222260	3566837209773	Corner step, liners P-75, grey	294.00
STRAIGHT STEP LINERS			
71220200	3566837209780	Straight steps, liners P-75 ≤ 2.10, white	383.00
71220210	3566837209803	Straight steps, liners P-75 ≤ 2.10, light blue	383.00
71220220	3566837209827	Straight steps, liners P-75 ≤ 2.10, dark blue	383.00
71220230	3566837209834	Straight steps, liners P-75 ≤ 2.10, green	383.00
71220240	3566837209841	Straight steps, liners P-75 ≤ 2.10, beige	383.00
71220260	3566837209858	Straight steps, liners P-75 ≤ 2.10, grey	383.00
71220700	3566837209865	Straight steps, liners P-75 > 2.10, white	407.00
71220710	3566837209872	Straight steps, liners P-75 > 2.10, light blue	407.00
71220720	3566837209889	Straight steps, liners P-75 > 2.10, dark blue	407.00
71220730	3566837209896	Straight steps, liners P-75 > 2.10, green	407.00
71220740	3566837209902	Straight steps, liners P-75 > 2.10, beige	407.00
71220760	3566837209919	Straight steps, liners P-75 > 2.10, grey	407.00
LINERS FOR STRAIGHT STEPS ACROSS THE WIDTH			
71221200	3566837209926	Straight steps across the width, liners P-75 ≤ 4.10, white	475.00
71221210	3566837209971	Straight steps across the width, liners P-75 ≤ 4.10, light blue	475.00
71221220	3566837209995	Straight steps across the width, liners P-75 ≤ 4.10, dark blue	475.00
71221230	3566837210007	Straight steps across the width, liners P-75 ≤ 4.10, green	475.00
71221240	3566837210014	Straight steps across the width, liners P-75 ≤ 4.10, beige	475.00
71221260	3566837210021	Straight steps across the width, liners P-75 ≤ 4.10, grey	475.00
71221300	3566837210038	Straight steps across the width, liners P-75 > 4.10, white	500.00
71221310	3566837210052	Straight steps across the width, liners P-75 > 4.10, light blue	500.00
71221320	3566837210069	Straight steps across the width, liners P-75 > 4.10, dark blue	500.00
71221330	3566837210076	Straight steps across the width, liners P-75 > 4.10, green	500.00
71221340	3566837210090	Straight steps across the width, liners P-75 > 4.10, beige	500.00
71221360	3566837210106	Straight steps across the width, liners P-75 > 4.10, grey	500.00
ROMAN STEP LINERS			
71222700	3566837210113	Roman steps, liners P-75 ≤ 3.10, white	435.00
71222710	3566837210120	Roman steps, liners P-75 ≤ 3.10, light blue	435.00
71222720	3566837210137	Roman steps, liners P-75 ≤ 3.10, dark blue	435.00
71222730	3566837210144	Roman steps, liners P-75 ≤ 3.10, green	435.00
71222740	3566837210151	Roman steps, liners P-75 ≤ 3.10, beige	435.00
71222760	3566837210168	Roman steps, liners P-75 ≤ 3.10, grey	435.00
71223200	3566837210199	Roman steps, liners P-75 > 3.10, white	484.00
71223210	3566837210205	Roman steps, liners P-75 > 3.10, light blue	484.00
71223220	3566837210212	Roman steps, liners P-75 > 3.10, dark blue	484.00
71223230	3566837210229	Roman steps, liners P-75 > 3.10, green	484.00
71223240	3566837210236	Escalier roman, liners P-75 > 3.10, sable	484.00
71223260	3566837210243	Roman steps, liners P-75 > 3.10, beige	484.00



P-75 LINERS FOR WOODEN POOLS

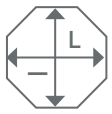

OCTAGONAL POOLS

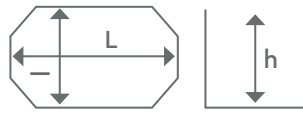

ELONGATED OCTAGONAL POOLS

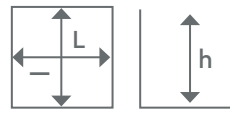

SQUARE POOLS

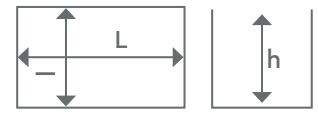

RECTANGULAR POOLS



0.75mm liner	Liner dimensions L x W x H	Code	EAN13	Code	EAN13	Code	EAN13	Unit price
OCTAGONAL POOLS, WEVA AND ODYSSEA								
Octo 440, H= 110	3.50 x 3.50 x 1.10	5252420	3566835474685	72215055	3566837159528	72220055	3566837159399	331.00
Octo 440, H= 120	3.50 x 3.50 x 1.20	5253820	3465843508101	72215056	3566837159511	72220056	3566837158491	340.00
Octo 440, H= 133	3.50 x 3.50 x 1.33	5263820	3465843508156	72215057	3566837159504	72220057	3566837159382	343.00
Octo 530, H= 117	4.35 x 4.35 x 1.20	5254820	3465843508118	72215059	3566837159498	72220059	3566837159375	413.00
Octo 530, H= 133	4.35 x 4.35 x 1.33	5264820	3465843508163	72215060	3566837159481	72220060	3566837159368	426.00
ELONGATED OCTAGONAL POOLS, WEVA AND ODYSSEA								
Octo+ 460, H= 120	4.28 x 2.78 x 1.20	5250730	3566837078546	72215070	3566837128562	72220070	3566837159351	350.00
Octo+ 540, H= 120	4.88 x 2.78 x 1.20	5256820	3566835530909	72215076	3566837159474	72220076	3566837159344	380.00
Octo+ 540, H= 133	4.88 x 2.78 x 1.33	5266820	3566837053192	72215077	3566837158484	72220077	3566837158507	392.00
Octo+ 610, H= 120	5.60 x 3.50 x 1.20	5259820	3566835531043	72215086	3566837159467	72220086	3566837159337	454.00
Octo+ 610, H= 133	5.60 x 3.50 x 1.33	72206087	3566837156817	72215087	3566837127244	72220087	3566837159320	467.00
Octo+ 640, H= 120	5.91 x 3.50 x 1.20	5257820	3465843508132	72215089	3566837159443	72220089	3566837159313	469.00
Octo+ 640, H= 133	5.91 x 3.50 x 1.33	5267820	3465843508187	72215090	3566837128579	72220090	3566837158514	484.00
Octo+ 640, H= 146	5.91 x 3.50 x 1.46	5277820	3566835498872	72215091	3566837128586	72220091	3566837158521	563.00
Octo+ 840, H= 120	7.91 x 4.35 x 1.20	5258820	3465843508149	72215096	3566837159436	72220096	3566837159306	635.00
Octo+ 840, H= 133	7.91 x 4.35 x 1.33	5268820	3465843508194	72215097	3566837128593	72220097	3566837158538	653.00
Octo+ 840, H= 146	7.91 x 4.35 x 1.46	5278820	3566835498865	72215098	3566837128609	72220098	3566837159290	755.00
SQUARE POOLS, WEVA AND ODYSSEA								
Square 3 x 3, H= 120	3.00 x 3.00 x 1.20	72606103	3566837123352	72215103	3566837128616	72220103	3566837159283	291.00
Square 3 x 3, H= 133	3.00 x 3.00 x 1.33	72606104	3566837123369	72215104	3566837128623	72220104	3566837159276	301.00
Square 4 x 4, H= 133	4.00 x 4.00 x 1.33	72606107	3566837123376	72215107	3566837128630	72220107	3566837159269	410.00
Square 5 x 5, H= 146	5.00 x 5.00 x 1.46	72206111	3566837149185	72215111	3566837161316	72220111	3566837161323	650.00
RECTANGULAR POOLS, WEVA AND ODYSSEA								
Rect. 4.5 x 3, H= 120	4.50 x 3.00 x 1.20	72606120	3566837123536	72215120	3566837128647	72220120	3566837159252	363.00
Rect. 6 x 3, H= 133	6.00 x 3.00 x 1.33	4802725	3566837078454	72215124	3566837159429	72220124	3566837159245	453.00
Rect. 8 x 4, H= 146	8.00 x 4.00 x 1.46	4815725	3566837078485	72215137	3566837159412	72220137	3566837159214	768.00
Rect. 9 x 3, H= 133	9.00 x 3.00 x 1.33	72606127	3566837123383	72215127	3566837128654	72220127	3566837159238	611.00
Rect. 10 x 5, H= 146	10.00 x 5.00 x 1.46	4818725	3566837078515	72215152	3566837159405	72220152	3566837159191	1,039.00
Rect. 12 x 3, H= 146	12.00 x 3.00 x 1.46	72606131	3566837123390	72215131	3566837128661	72220131	3566837159221	896.00
Rect. 12 x 4, H= 146	12.00 x 4.00 x 1.46	72606143	3566837123406	72215143	3566837128678	72220143	3566837159207	1,025.00
URBAN POOLS								
6.00 x 2.50 H=1,33	5.5 x 2.00 x 1.33	-	-	-	-	72220160	3566837175085	304.00
4.2 x 3.50 H=1,33	3.6 x 3.00 x 1.33	-	-	-	-	72220163	3566837175078	285.00
6.00 x 3,00 H=1,33	6.00 x 3.00 x 1.33	-	-	-	-	72220169	3566837224264	458.00
POOL'N BOX POOLS								
5.00 x 2.00 H=1.33	5.00 x 2.00 x 1.33	-	-	-	-	72220113	3566837224240	286.00



0.50MM LINERS FOR TROPIC POOLS

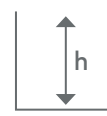
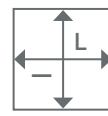
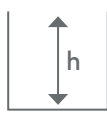
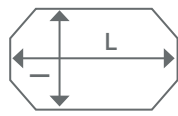
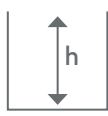
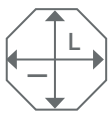

OCTOGONAL POOLS

ELONGATED OCTAGONAL POOLS

SQUARE POOLS



Code	EAN13	Description	Dimensions L x l x h	Unit price
HEXAGONAL POOLS				
72106050	3566837122126	Liner P-50, wooden pool, hexa 410, H= 117, Dark blue	3.05 × 3.05 × 1.20	237.00
OCTAGONAL POOLS				
5281420	3566835499121	Liner P-50, wooden pool, octo 360, H=090, Dark blue	2.78 × 2.78 × 0.93	213.00
5251420	3566835512080	Liner P-50, wooden pool, octo 360, H=106, Dark blue	2.78 × 2.78 × 1.09	223.00
5253420	3566835474715	Liner P-50, wooden pool, octo 414 or 440, H=117, Dark blue	3.50 × 3.50 × 1.20	264.00
5263420	3566835474760	Liner P-50, wooden pool, octo 414 or 440, H=129, Dark blue	3.50 × 3.50 × 1.33	271.00
5254420	3566835474722	Liner P-50, wooden pool, octo 505 or 530, H=117, Dark blue	4.35 × 4.35 × 1.20	317.00
5264420	3566835474777	Liner P-50, wooden pool, octo 505 or 530, H=129, Dark blue	4.35 × 4.35 × 1.33	327.00
ELONGATED OCTAGONAL POOLS				
72506068	3566837175429	Liner P-50, wooden pool, octo +450, H=120, Dark blue	4.16 × 2.78 × 1.20	275.00
5230720	3566837100841	Liner P-50, wooden pool, octo +460, H=133, Dark blue	4.28 × 2.78 × 1.13	377.00
72106073	3566837122133	Liner P-50, wooden pool, octo +510, H= 117, Dark blue	4.59 × 3.02 × 1.20	299.00
5250420	3566837104917	Liner P-50, wooden pool, octo +540, H=177, Dark blue	4.88 × 2.78 × 1.20	299.00
5257420	3566835474692	Liner P-50, wooden pool, octo +640, H=117, Dark blue	5.91 × 3.50 × 1.20	361.00
5267420	3566835474746	Liner P-50, wooden pool, octo +640, H=129, Dark blue	5.91 × 3.50 × 1.33	371.00
5258420	3566835474708	Liner P-50, wooden pool, octo +840, H=117, Dark blue	7.91 × 4.35 × 1.20	471.00
5268420	3566835474753	Liner P-50, wooden pool, octo +840, H=129, Dark blue	7.91 × 4.35 × 1.33	485.00
PISTOCHE AND TROPIC JUNIOR POOLS				
72506100	3566837158569	Liner P-50, Pistoche, 2 × 2, H= 68, Dark blue	2.00 × 2.00 × 0.68	80.80

0.50MM LINERS FOR ABOVE-GROUND SHEET METAL WALL POOLS - DARK BLUE

Code	EAN13	Description	Qty	Unit price	Qty	Unit price	Qty	Unit price
5300321	3566831113847	Liner P-50, above-ground, round, 2.44 × 0.40m	1	89.40	18	84.93	36	80.46
5301323	3566831113854	Liner P-50, above-ground, round, 3.05 × 0.60m	1	150.10	18	142.60	36	135.09
5302325	3566831113861	Liner P-50, above-ground, round, 3.66 × 0.90m	1	233.00	18	221.35	36	209.70
5303325	3566835013693	Liner P-50, above-ground, round, 3.97 × 0.90m	1	273.00	18	259.35	36	245.70
5304325	3566831113878	Liner P-50, above-ground, round, 4.58 × 0.90m	1	324.00	18	307.80	36	291.60
5304327	3566831113885	Liner P-50, above-ground, round, 4.58 × 1.20m	1	375.00	18	356.25	36	337.50
5306327	3566831131452	Liner P-50, above-ground, round, 5.48 × 1.20m	1	487.00	18	462.65	36	438.30
5308327	3566831131469	Liner P-50, above-ground, round, 6.40 × 1.20m	1	602.00	18	571.90	36	541.80
5309327	356683113915	Liner P-50, above-ground, round, 7.32 × 1.20m	1	782.00	18	742.90	36	703.80
5310327	3566831131476	Liner P-50, above ground, oval, 5.00×3.20×1.20m	1	296.00	18	281.20	36	266.40
5311327	3566831131483	Liner P-50, above ground, oval, 5.49×3.66×1.20m	1	343.00	18	325.85	36	308.70
5313327	3566831131506	Liner P-50, above ground, oval, 7.32×3.66×1.20m	1	463.00	18	439.85	36	416.70
5314327	3566831131513	Liner P-50, above ground, oval, 8.24×4.58×1.20m	1	554.00	18	526.30	36	498.60
5315327	3566831131520	Liner P-50, above ground, oval, 9.15×4.58×1.20m	1	629.00	18	597.55	36	566.10
5316327	3566831131537	Liner P-50, above ground, oval, 10.00×5.49×1.20m	1	745.00	18	707.75	36	670.50
5317327	3566831131544	Liner P-50, above ground, oval, 12.00×5.49×1.20m	1	887.00	18	842.65	36	798.30



AQUALUX, SUNBAY, UNIVERSO BOIS AND UBBINK

INFOS

PLEASE NOTE

BWT MyPOOL compatible liners will be invoiced per m² using the product codes listed on page 68.

LIGHT
BLUE

DARK
BLUE

Description	Dimensions liners (L x W x H)	m ² invoiced	Unit price*
Liner P-75/100 Aqualux – Octo +645, H=128, Dark blue	3.60 x 3.12 x 1.20	30	333,00
Liner P-75/100 Aqualux – Hexa 422, H=128, Dark blue	4.25 x 4.25 x 1.28	44	488,40
Liner P-75/100 Aqualux – Octo 520, H=128, Dark blue	5 x 3 x 1.28	39	432,90
Liner P-75/100 Aqualux – Octo +550, H=128, Dark blue	6 x 4.25 x 1.28	52	577,20
Liner P-75/100 Piscine Bois Octo 530, H= 120, Dark blue	4.37 x 4.37 x 1.20	43	477,30
Liner P-75/100 Piscine Bois Octo 530, H= 133, Dark blue	4.37 x 4.37 x 1.33	42	466,20
Liner P-75/100 Sunbay Hexa 360, H= 116, Dark blue	3.6 x 3.12 x 1.16	30	333,00
Liner P-75/100 Sunbay Octo 417, H= 116, Dark blue	3.85 x 3.85 x 1.16	36	399,60
Liner P-75/100 Sunbay Octo+ 500, H= 116, Dark blue	5 x 3.17 x 1.16	39	432,90
Liner P-75/100 Sunbay Octo+ 500, H= 130, Dark blue	5 x 3.17 x 1.30	41	455,10
Liner P-75/100 Sunbay Octo+ 600, H= 116, Dark blue	6 x 4 x 1.16	47	521,70
Liner P-75/100 Sunbay Octo+ 600, H= 130, Dark blue	6 x 4 x 1.30	50	555,00
Liner P-75/100 Sunbay Octo+ 637, H= 145, Dark blue	6.37 x 4.37 x 1.45	59	654,90
Liner P-75/100 Sunbay Octo+ 837, H= 145, Dark blue	8.37 x 4.37 x 1.45	74	821,40
Liner P-75/100 Sunbay Déca 529, H= 130, Dark blue	4.89 x 4.89 x 1.30	49	543,90
Liner P-75/100 Sunbay Déca+ 987, H= 145, Dark blue	9.87 x 5.58 x 1.45	100	1110,00
Liner P-75/100 Sunbay Rectangulaire – Octo 575, H= 130, Dark blue	5.75 x 3.8 x 1.30	47	521,70
Liner P-75/100 Sunbay Rectangulaire – Octo 776, H= 145, Dark blue	7.76 x 3.8 x 1.45	63	699,30
Liner P-75/100 Sunbay Rectangulaire 5,6x3,8, H= 145, Dark blue	5.63 x 3.8 x 1.45	49	450,80
Liner P-75/100 Sunbay Rectangulaire 7,7x3,8, H= 145, Dark blue	7.72 x 3.8 x 1.45	63	579,60
Liner P-75/100 Universo Bois Hexa 500, H= 120, Dark blue	4.2 x 3.64 x 1.20	37	410,70
Liner P-75/100 Universo Bois Hexa 500, H= 133, Dark blue	4.2 x 3.64 x 1.33	40	444,00
Liner P-75/100 Universo Bois Octo 430, H=133, Light blue	3.5 x 3.5 x 1.33	33	366,30
Liner P-75/100 Universo Bois Octo 490, H= 133, Dark blue	4.9 x 4.9 x 1.33	49	543,90
Liner P-75/100 Universo Bois Octo 510, H= 133, Light blue	4.23 x 4.23 x 1.33	44	488,40
Liner P-75/100 Universo Bois Octo 580, H= 133, Light blue	4.96 x 4.96 x 1.33	50	555,00
Liner P-75/100 Universo Bois Octo+ 603, H= 133, Dark blue	6.02 x 3.34 x 1.33	44	488,40
Liner P-75/100 Universo Bois Octo+ 604, H= 133, Dark blue	6.4 x 4 x 1.33	52	577,20
Liner P-75/100 Universo Bois Octo+ 804, H= 133, Dark blue	7.90 x 4 x 1.33	62	688,20
Liner P-75/100 Universo Bois ALL 550x400, H= 133, Light blue	5 x 3.5 x 1.33	43	477,30
Liner P-75/100 Universo Bois ALL 610x400, H= 133, Light blue	6.1 x 4 x 1.33	50	555,00
Liner P-75/100 Universo Bois ALL 670x400, H= 133, Light blue	6.7 x 4 x 1.33	54	599,40
Liner P-75/100 Universo Bois ALL 820x400, H= 133, Light blue	8.2 x 4 x 1.33	64	710,40
Liner P-75/100 Ubbink Hexa 410, H= 120, Dark blue	3.36 x 2.91 x 1.20	26	288,60
Liner P-75/100 Ubbink Octo 430, H= 120, Dark blue	3.4 x 3.4 x 1.20	30	333,00
Liner P-75/100 Ubbink Octo 510, H= 120, Dark blue	4.23 x 4.23 x 1.20	42	466,20
Liner P-75/100 Ubbink Octo 580, H= 128, Dark blue	4.91 x 4.91 x 1.28	49	543,90
Liner P-75/100 Ubbink Octo+ 550, H= 120, Dark blue	6 x 3.5 x 1.20	43	477,30
Liner P-75/100 Ubbink Octo+ 610, H= 128, Dark blue	6.1 x 4 x 1.28	50	555,00
Liner P-75/100 Ubbink Octo+ 860, H= 128, Dark blue	8.2 x 4.2 x 1.28	66	732,60

* Brand name owned by a company with which BWT has no ties. The brand name is mentioned here as a compatible reference for wooden pools of the named brand, in accordance with the provisions set out in article L713-6-b of the French Intellectual Property Code.



ACCESSORIES FOR LINERS 



	Code	EAN13	Description	Qty	Unit price	Qty	Unit price	Qty	Unit price
1	1820119	3566837158088	Conventional Hung liner lock	20	1.99	50	1.88	100	1.77
2	1820719	3566837158095	Sub coping Hung liner lock	20	1.99	50	1.88	100	1.77
	30309019	3566837175016	Hung Alu P liner lock - 90° Angle P-PSC Paradis Bleu panels	4	19.35	12	18.28	48	17.20



A photograph of a wooden pool with a blue interior, set in a grassy area with trees in the background. The image is partially obscured by a pink overlay on the right side.

05

BWT myPOOL Wooden pools

WINTERIZING	77
PROTECTION & SECURITY	79
THE POOL'N BOX	94
TROPIC JUNIOR	96
THE TROPIC RANGE	98
THE WEVA RANGE	104
THE ODYSSEA RANGE	112
WOODEN POOL PACKAGING DATA	122



WOOD A NATURAL MATERIAL

SUSTAINABLE FORESTRY

BWT is committed to using wood from sustainably managed forests. As a guarantee, we have had our products certified by a renowned organisation and we organise regular inspections by an independent body.

BWT is PEFC certified (chain of custody: FCBA/12-01382) for procurement of wood from sustainably managed forests according to the regulations set out by the Programme for the Endorsement of Forest Certification.

The PEFC label pertains to wood from European forests. This programme promotes the preservation of our heritage.

Being a natural material, wood will have some imperfections. These are normal and have no impact on the service life of the product.

A certain number are superficial and are not covered within the scope of the guarantee.

CAREFULLY SELECTED, CAREFULLY TREATED WOOD

**Class IV autoclaved northern wood:
the right choice for the pool structure**

The mechanical and aesthetic properties of this wood are the result of its slow growth imposed by rigorous climatic conditions north of the 57th parallel. Class IV treatment in the autoclave makes this wood perfect for use outdoors in contact with the ground.

INFOS **STORAGE**
If you do not intend to assemble your pool immediately, you should store it without opening it in a well-ventilated room, or failing this, in year area protected from humidity and sunlight. If, however, you were obliged to unpack your pool, redo and restrap the pallet. Once the pallets are undone, the kit must be assembled within 24 to 48 hours.

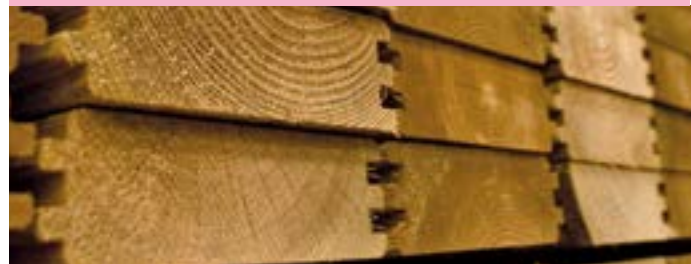

INFOS All in-ground and partially in-ground pools must be protected using a Delta MS drainage membrane.

MADE IN FRANCE
**Composite French wood:
ideal for pool coping.**
A balanced mix of fine wood particles and a thermoplastic polymer, composite wood is free of knots, splinters and boasts year excellent service life outdoors. Soft to the touch, it is also low maintenance and comes in a range of colours (Coastal Grey or Havana).

COLOUR VARIATIONS

Colour variations are common to every species of wood. Treatment brings them out because the depth of penetration of the product will depend on the wood density and grain. Weathering of wood outdoors will significantly attenuate these colour variations.



SALT STAINS

Small green stains are frequently found on the surface of autoclaved wood. These can be removed with light sanding. If left untreated, this colour will disappear over time.



SPLITTING AND CRACKING

Wood expands and contracts when exposed to variations in humidity and temperature. As it dries, wood contracts unevenly resulting in the appearance of cracks. While these can seem to be cause for concern, they have no impact on the mechanical properties of the product and therefore do not fall within the scope of the guarantee.



SURFACE MOULD

Mould, caused by microscopic fungi, can grow on wood, particularly on resinous species, on which the growth can appear as "blueing". It is a surface phenomenon, exacerbated by heat, humidity and inadequate aeration and is characterised by stains ranging from light to dark blue. They can be removed by wiping the surface.

Remember that class IV treated wood is protected against attack by fungi that could destroy the physical and mechanical properties of the wood. For further information, please refer to Procopi's guarantees concerning the types of wood and their treatment.



RESIN BEADING

When resinous wood species are autoclaved, the alternating pressure and vacuum can cause sticky resin residues to rise to the surface. To remove them, scrape them carefully with year appropriate tool, being careful not to touch the wood. Turpentine spirits could also be effective, but could stain the wood if too much is applied.



GREYING

Wood exposed to sunlight is susceptible to greying. Some people like the silvery sheen of this natural patina. If, however, you would prefer the wood to keep its original colour with brown tones, apply a protective coating (lasure, oil) when the product is assembled.



KNOTS

Knots mark the places where branches were attached. The quantity and size depends on the species of wood and the sorting process. For outdoor installations, small adherent knots are acceptable. The more stringent the sorting process to limit the number and size of knots, the more expensive the wood will be.



JOINED WOOD

To ensure the highest quality in the selection of our wood, it is sorted meticulously before planing. Planks that feature defects on both sides are taken out. Defects (knots, cracks, flashes) are removed and the planks are joined together (see the image above).

This is why it is not unusual to find joined elements in a wooden pool, it in no way penalises the mechanical properties of the wood. For the same reason, imperfections on the interior surface of the pool (knots, cracks, flashes) are entirely acceptable.



WARPED WOOD

Due to the constant pressure exerted by the pool water, the walls constituting the length of the pool may warp slightly over time.

this phenomenon, due to wood's natural elasticity, will stabilise of its own accord and will not cause the wood slats to fail.

This is not a defect and will not constitute grounds for a guarantee claim.



A SUITABLE FILTRATION GROUP

The majority of the fittings and accessories equipping BWT MyPOOL pools are made in France. You can be sure of excellent manufacturing quality, stringent quality control and perfect suitability.

Notably, each pool is fitted with a filtration group, that is a pump-filter combination, selected to filter the pool water in accordance with the standards in effect.

Only a good balance between the power of the pump and filtration

surface area can ensure efficient filtration. If the through rate is too high for the surface area of the sand (determined by the diameter of the filter), filtration will not be optimal. The maximum filtration rate for sand filters as defined by the standards is $50\text{m}^3/\text{h}/\text{m}^2$.

For this reason, BWT tests each pool model/filtration group configuration in situ and monitors the flow rates and through put rates. These tests are evaluated by independent laboratories who issue certificates of compliance.

THE PUMP DRIVES WATER CIRCULATION:

it draws water in through the skimmers and vacuum points (if any), pushes it through the filter and then returns the water to the pool through the return fittings.

THE SAND FILTER RETAINS IMPURITIES:

As it passes through the filter medium, impurities (leaves, dust, etc.) are retained and the water is purified. It flows out of the filter clear.

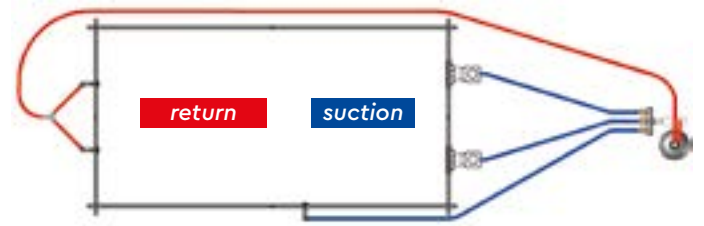

WATER TREATMENT AND HYGIENE, A FEW BASIC PRINCIPLES.

As regards hygiene, there are no official regulations governing private pools. However, for the sake of your own health and that of those closest to you, we have provided some information on water treatment and basic maintenance of the filtration group.

WATER TREATMENT

To get the most out of your pool, you will need to optimise pool water treatment. Follow the recommendations concerning use of your filtration group: commissioning, frequency of use, bather load, water regeneration, maintenance and monitoring of this system (pipes, bolts, screws) and build-up of dirt in the filter (refer to the back washing procedure in the installation instructions enclosed with the filter).

Failure to respect maintenance recommendations will entail serious health risks, notably for children.



HYGIENE

For the sake of your own health and that of those closest to you, you need to follow some rules!

This starts with good personal hygiene for the respect of all. Next, to ensure crystal clear water, follow the instructions set out under the "operation and maintenance" heading of the installation instructions. Pay particular attention to water treatment and testing intervals, as well as filtration and back wash cycles. Your pool water equilibrium depends mainly on you. Do not hesitate to consult any relevant documentation and follow the advice of professionals



WINTERIZING

WINTERIZING THE POOL AND THE HYDRAULIC INSTALLATION



- » Carry out a prolonged filter back wash. Never empty the pool for winter (or for any long period of time).
- » In fact, the liquid mass plays a dual role acting as both thermal insulation and ballast, keeping the liner and the pool structure in good condition. The water level, however, should be lowered to 10cm below the mouth of the skimmer.
- » To drain water from the pool, either use a siphon, or turn the handle on the multi-port pump to Drain and allow the water to run out under the effect of gravity.
- » Water will flow out through the waste line. Do not run the pump during procedure.
- » Disconnect the pipe underneath the skimmer to allow the skimmer to act as year overflow in the event that precipitation causes the water level to rise too high. Remove any water treatment products from the skimmer (Chlorine tablets, flocculent, etc.).
- » Unscrew the face ring on the return fitting inside the pool. Using a threaded or rubber winterizing cap (not supplied), seal the return fitting from inside the pool.
- » Disconnect the return line at the pump.
- » Drain water from the filter by unscrewing the drain plug at the bottom of the filter tank.
- » Do not replace the drain plug until the filter is being put back into service.
- » Unscrew the drain plugs on the pump and prefilter. In the case of unprotected outdoor installations, remove and store the pump.
- » Cut power to the filtration control panel.
- » Add year algacide and a winterizing product to the pool water (not supplied).
- » - Remove the stainless steel ladder.
- » - Deploy the winterizing cover over the pool.

NOTE: Winterizing is not mandatory, especially in climates where temperatures do not drop below zero. In this case, simply maintain the usual water level in the pool and run filtration for 2 to 3 hours each day. Check the water level in the pool at regular intervals.

THE WOOD

Wood is a living material, variations in temperature and humidity can cause it to contract or expand causing the wood to split or crack, this a natural phenomenon and in no way effects the service life of our products.

The wood is subjected to a class IV autoclaving treatment that complies with standards in effect and presents absolutely no danger to people or animals in direct contact with the wood.

Under no circumstances should you apply any product such as wood stain, paint, oil, micro-porous product, etc. to the wood.

Over time, the wood of the pool will inevitably get dirty. Clean the wood once a year using a high pressure jet, to remove dirt lodged in the pores in the wood. Regulate the water pressure to avoid damaging the surface of the wood or raising and fibres.

Inspect the wooden structure regularly (particularly the coping and access steps) and eliminate any splinters that may have appeared.

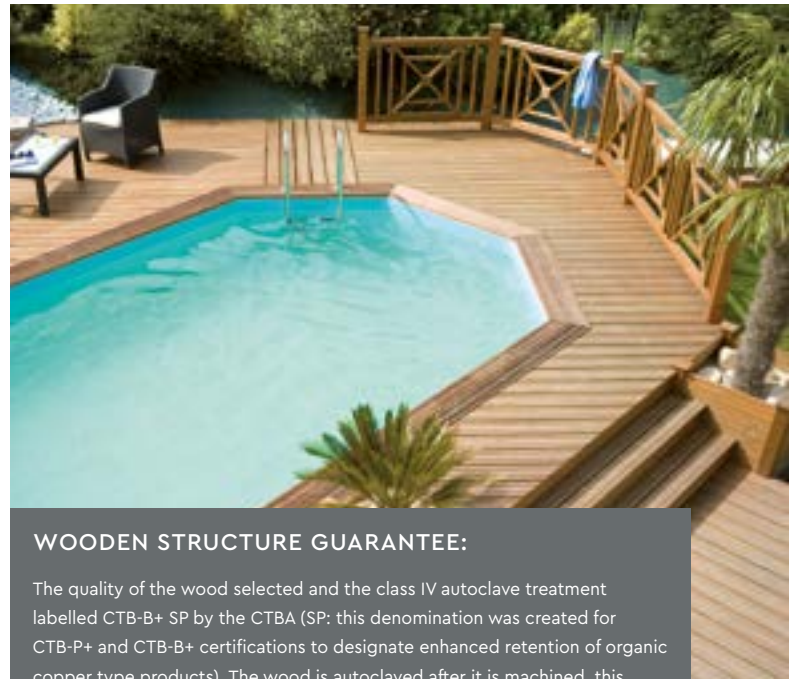

WOODEN STRUCTURE GUARANTEE:

The quality of the wood selected and the class IV autoclave treatment labelled CTB-B+ SP by the CTBA (SP: this denomination was created for CTB-P+ and CTB-B+ certifications to designate enhanced retention of organic copper type products). The wood is autoclaved after it is machined, this allows us to offer a 10 year guarantee on our wooden structures.



BWT

DOES NOT JUST OFFER A COMPREHENSIVE RANGE OF PRODUCTS,

*From deliveries to technical Advice,
we are there for you Every step of the way.*

DELIVERY TO YOUR DOOR,

Please contact us to discuss terms.

THE INTERNET SITE

- » Product data sheets,
- » Installation instructions,
- » Customer accounts, order tracking



STANDARD NF P90-307-1



STANDARD NF P90-306

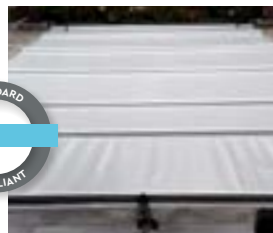
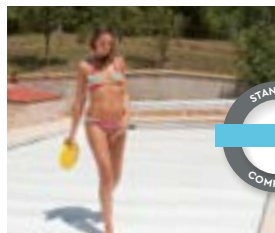

STANDARD NF P90-306



BWT myPOOL wooden pools may be installed above-ground, in-ground or partially in-ground. Partially in-ground refers to a configuration where the pool structure is under the ground level, irrespective of the depth to which the structure is sunk

All in-ground and partially in-ground pools must be equipped with at least one of 4 safety standard compliant devices designed to prevent the risk of drowning

In the case of above-ground pools, the pool must be secured by removing the access ladder. All BWT myPOOL pools are fitted with ladders that fold upwards as standard.

However, BWT recommends that you reinforce safety by installing one of the systems mandatory for in-ground and partially in-ground pools.

THE LAW PROVIDES FOR 4 MEANS OF SECURING THE POOL::

- » FRENCH STANDARD NF P90-306 | Security fence, minimum height 110cm measured from the ground with a gate that is held closed,
- » FRENCH STANDARD NF P90-307-1 | P-AS fall detection alarm,
- » FRENCH STANDARD NF P90-308 | Safety cover,
- » FRENCH STANDARD NF P90-309 | Pool shelter

In this BWT catalogue, you will find a range of standard compliant security systems: the P-AS alarm, winter and safety covers, bar covers and P-HS E automatic covers.

INFOS

Standard compliant security systems are no substitute for the constant vigilance of parents or responsible adults.

STANDARD COMPLIANT EQUIPMENT

Accreditation testing is carried out by year independent laboratory that may, if it is deemed necessary, request modification

of the equipment or the installation instructions, and/ or in our own laboratory.

Once all tests have been successfully passed, the laboratory issues a certificate of compliance for each pool model tested.

Every BWT myPOOL pool complies with French and European standards in effect governing pool kits :

- » NF EN 16582-1 | Private family pools/ part 1: general safety requirements and test methods.
- » NF EN 16582-2 | Private family pools/ part 2: general safety requirements and test methods for in-ground pools.
- » NF EN 16582-3 | Private family pools/ part 3: general requirements concerning security and test methods for above-ground pools.
- » NF EN 16713-1 | Private family pools/ Water distribution systems – Part 1: Filtration systems/ Requirements and test methods.
- » NF EN 16713-2 | Private family pools/ Water distribution systems – Part 2: Circulation systems/ Requirements and test methods
- » NF EN 16927 | Specific requirement, safety requirements and test methods

Pistoche

PISCINE URBAINE

TROPIC



Everyone into Pistoche!

Safe, solid, beautiful and very safe, the little Pistoche pool is year instant hit with small children and ensures instant peace of mind for the adults watching over them. Carefully designed for enjoyment and safety, Pistoche is the ideal pool for little children and cautious parents.



STYLISH FINISH!

» Pistoche pools are now equipped with Aluminium coping.



ABOVE-GROUND CHILDREN'S POOL



SAFE



SELF-WINDING SAFETY COVER. *

Pistoche is equipped with a safety cover. Discrete and easy to use, the cover secures the pool while it is not in use. In addition to securing the pool, the cover protects the pool against evaporation and night time cooling. It also prevents pollen, dust and leaves from falling into the pool. The water stays clean, always ready for your little swimmers. A Pistoche exclusive!



1
The cover is built into a cover pit that is hidden under the edging.

2
Once the edging on all 4 sides has been lifted, the cover can be rolled out in just a few seconds by pulling on the strap, a sharp tug will cause the cover to automatically roll up.

3
Strong and hard wearing and fitted with a purpose designed fastening system, the cover can bear the weight of a small child.

* This cover is no substitute for common sense or individual responsibility. Nor is it intended to replace the vigilance of parents and/or responsible adults which remains the key factor in ensuring the safety of young children.

SOLID



MADE IN FRANCE - 2 YEAR GUARANTEE.

Pistoche pools are made in Brittany in Northern France. Hard wearing materials and manufacturing quality are fully guaranteed.

WOOD

SOLID, TREATED WOOD - STRUCTURE MADE OF NORTHERN RED PINE (CLASS III & IV), GUARANTEED FOR 2 YEARS

Sturdy and aesthetic, Pistoche has a place in every garden.



EVOLUTIVE



ADJUSTABLE FILTRATION HEIGHT, FOR A WATER LEVEL BETWEEN 40 AND 60CM.

The cartridge filter, that ensures the quality of water in the pool, may be installed in any of the four corners so that it faces into the prevailing wind. The depth of the water may be adjusted depending on the height and age of the children: forty centimeters for the youngest children to splash around, and up to sixty centimeters for older children to start swimming. A Pistoche exclusive !

A Pistoche exclusive just for us!

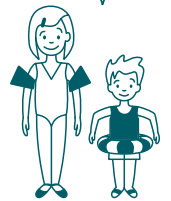



Pistoche

by PROCOPI | Member of BWT group.

ABOVE-GROUND CHILDREN'S POOL



COPING

- » May be locked
- » Lacquered, light grey aluminium

SAFETY COVER

- » Grey, reinforced 450g/m² PVC fabric

SELF-WINDING ROLLER

- » Housed discreetly under the coping

LINER

- » 0.50mm, dark blue

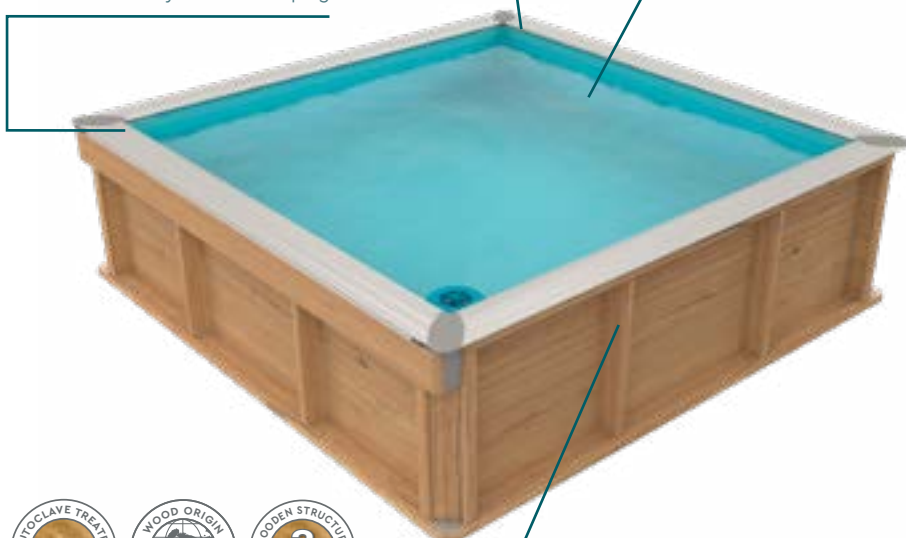

INTERLOCKING STRUCTURE

- » Northern pine, class III and IV,
- » Thickness, 28mm.



UNDERLAY

- » Underlay to be fitted under the liner.



CARTRIDGE FILTER

- » Height adjustable for a water level between 40 and 60cm.



Code	EAN13	Description	Qty	Unit price	Qty	Unit price	Qty	Unit price	Qty	Unit price	Qty	Unit price
27160209	3566837150624	Pistoche 2x2 x 0.64m	1	650.00	4	604.50	12	598.00	36	591.50	102	585.00

For transport costs, please enquire.

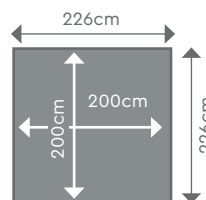

STANDARD EQUIPMENT

Description	
Lockable, light grey lacquered Aluminium coping	included
Planks of solid, class III and IV treated Northern Pine, thickness in mm, tolerance + or - 1mm	28
Liner thickness	0.50mm
Liner colour	Dark blue
Self-winding safety cover	grey

Description	
Height adjustable cartridge filter, water level from 40 to 60cm	included
Underlay	included
Guarantee on the structure	2 years
Liner guarantee	2 years
Filter guarantee	1 year

ABOVE-GROUND CHILDREN'S POOL

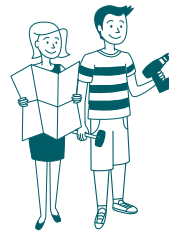

IN TWO PACKAGES

THE PISTOCHE POOL COMES IN TWO PACKAGES.

Package 1 contains: the height adjustable filtration system, blue, 0.50mm liner, the underlay and the screws. The wooden structure is enclosed in the second package (included in the advertised price), this package contains all the wooden elements, the aluminium coping, the PVC profiles and the roller pre-fitted with the safety cover and its strap.

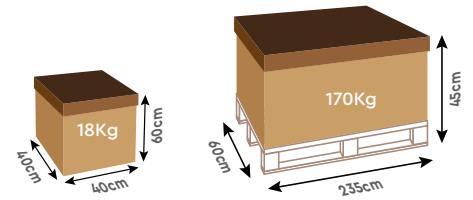

ACCESSORIES



THE MAINTENANCE KIT COMPRISES:

- » 3 graduated containers (1 litre) of bleach,
- » 1 graduated container (1 litre) of algicide



THE ACCESSORIES KIT COMPRISES: :

- » 1 venturi cleaner
- » 1 skimmer
- » 1 pole with 5 sections to be mounted on the cleaner or the skimmer
- » 1 thermometer
- » 1 water line brush with 3 refills



	Code	EAN13	Description	Qty	Unit price	Qty	Unit price	Qty	Unit price
PISTOCHE ACCESSORIES AND MAINTENANCE									
1	27900200	3566837170882	Pistoche cleaning accessories kit	1	28.70	10	27.27	20	25.83
2	27900210	3566837170899	Pistoche pool water treatment kit	1	30.00	10	28.50	20	27.00
3	27900215	3566837175511	Pistoche reversible winter cover (PE 200g/m ²) with 8 eyelets around the periphery	1	39.60	6	37.62	12	35.64
4	27931650	3566837162061	Pistoche spare cartridge	1	16.00	8	15.20	16	14.40

URBAN POOLS

my beautiful pool, where I want, when I want!

URBAN pools are innovative: they combine the advantages usually associated with top-end pools, with the practical advantages of more modestly sized pools. Thanks to its small size, you can install your URBAN pool wherever you want.



WOODEN STRUCTURE GUARANTEE

URBAN pools are made using wood from sustainably managed forests.

The quality of the wood selected and the class IV autoclave treatment are labelled CTB-B+ SP by the CTBA.

The autoclave treatment is carried out after machining, this allows us to offer a 10 year guarantee on the structure.

THE BEST OF TECHNICAL KNOW-HOW AND SAFETY

Fitted with submerged automatic covers that comply with the French pool safety standard (NF P 90-308), URBAN pools provide optimal safety and comfort of use.

Secreted under the pool edging, the submerged cover keeps the pool water clean and warm. It secures and protects your pool with total discretion.

In addition, URBAN pools are fitted out with high-end, state of the art technical equipment: LED underwater lights, automatic filtration management, in-pool ABS stainless steel ladder (2 sections), wooden access ladder, skimmer and return fittings the same colour as the liner and the automatic cover.



In just a few seconds, with the turn of a key, the cover hidden under the coping rolls out over the surface of the water. Effortless protection for your pool.



PURE LINES

The intelligent, elegant design of the URBAN POOL guarantees seamless aesthetic integration into your garden. The structure, made of carefully selected solid wood, is compatible with in-ground, partially in-ground or above-ground installation. If the pool is installed in-ground or partially in-ground, a wooden plant housing (option) must also be installed to allow access to the filtration equipment.



URBAN pools embellish any space, giving it instant visual appeal.



ACHIEVE THE IMPOSSIBLE
YOUR DREAMS
WITHIN YOUR
GRASP

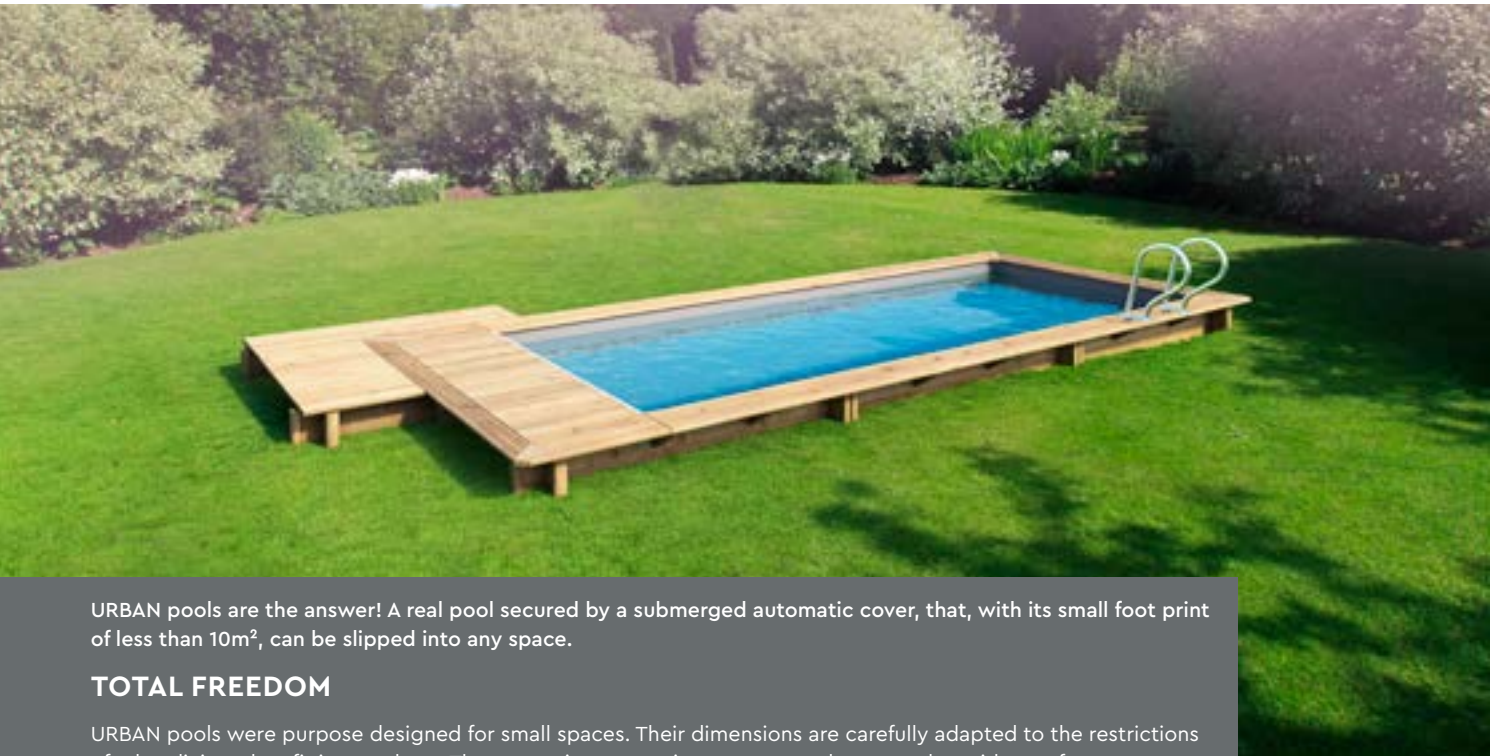

URBAN pools are the answer! A real pool secured by a submerged automatic cover, that, with its small foot print of less than 10m², can be slipped into any space.

TOTAL FREEDOM

URBAN pools were purpose designed for small spaces. Their dimensions are carefully adapted to the restrictions of urban living, they fit in anywhere. They come in two versions, square and rectangular, with a surface area never exceeding 10 m².

A SEDUCTIVE PRICE POINT

URBAN pools are real pools, fitted out like luxury pools and offered at a very interesting price. The Secret? Industrialisation of the design and manufacturing process. The factory in France where URBAN Pools are made, is a reference in this sector; it relies on tried and tested know-how and uses the best, state-of-the-art manufacturing equipment.



IDEAL FOR A BUSY LIFE-STYLE!

The URBAN pool is designed for busy city living. Its clever design simplifies and reduces maintenance, and the consumption of water, energy and pool chemicals is very low.

bwt.com

WARM, LIMPID WATER

URBAN pools were designed to accept optional equipment usually reserved to large top of the range pools. Notably a plant housing large enough to hold a sand filter and a heat pump. Warm, clean water; you can enjoy an extended pool season.



SWIM!

Whether for pleasure, or to train, URBAN pools may be fitted with static swim belts (included as standard); ideal for working out at the intensity that you want. Comprised of a neoprene belt (waist circumference 60-105cm) and year elastic strap (length 200cm), it is the ideal system for an aquatic work out in a small pool.



URBAN POOLS

my beautiful pool, where I want, when I want!

LADDER

- » Aluminium/ABS ladder, 2 sections, 3 treads
- » Wooden access ladder, 4 treads



COPING

- » Double pine
- » Thickness 28mm
- » Width 290mm



AUTOMATIC COVER

- » Light grey



LINER

- » 0.75mm, light grey

UNDERWATER LIGHTS

- » 1 halogen uw lights,
- » 1 electrical panel.



INTERLOCKING STRUCTURE

- » Class IV treated solid Northern pine
- » Thickness 45mm

SWIM TETHER

- » Neoprene belt
- » Tether with click 2m
- » Pool deck fastener, 1 SS peg with bushing D6



UNDERLAY

- » Undelay to be fitted under the liner



CARTRIDGE FILTER

- » Filtration 4 m³/h

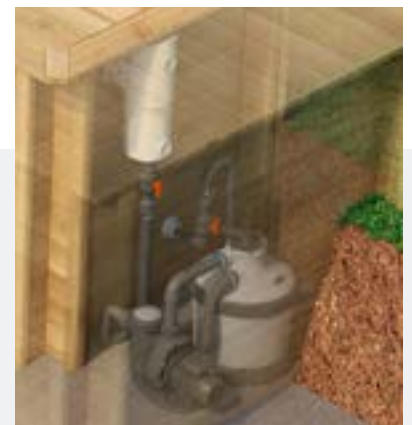

SAND FILTER (OPTION)

- » Light grey sand filter
- » P-GFI 400 4m³/h
- » Removable lid
- » 6-way valve
- » Self-priming pump with pre-filter
- » Pump/ filter connection kit
- » Black ABS base
- » Delivered with the filter medium



ABOVE-GROUND/ PARTIALLY IN-GROUND / IN-GROUND



INFOS Above-ground Urban pool with deck.



NON-CONTRACTUAL PHOTO

©ANAMIG



NON-CONTRACTUAL IMAGE

©ANAMIG



NON-CONTRACTUAL PHOTO

©ANAMIG

BEFORE/ AFTER

URBAN POOLS

My beautiful pool, where I want, when I want!



STRUCTURE
POOL FITTINGS



AUTOMATIC
COVER



LADDER
FILTRATION
LINER



4 LEVELS OF EQUIPMENT



*Integrated, automatic cover
and compact cartridge filter*

AUTOMATIC COVER*

Housed discreetly in the pool, the submerged cover keeps the pool water clean and warm. It effortlessly secures and protects your pool.

* Version without plant housing, above-ground only



*Integrated, automatic cover
and wooden plant housing*

WOODEN PLANT HOUSING

The wooden housing is made of slats 28mm thick. The lid profile corresponds to the pool coping. In accordance with the French safety standard NFP 90-308, the lid is hinged and fitted with a lock. The plant housing is mounted at a corner to house the electrical components of the automatic cover and the filtration system. The plant housing is mandatory for in-ground and partially in-ground installation configurations.



*Integrated, automatic cover, wooden
plant housing, and sand filtration group*

SAND FILTER

Comprised of a light grey sand filter P-GFI 400, 4m³/h, (delivered with the filter medium) with a removable lid, a self-priming pump with a pre-filter, a 6-way valve, a pump/ filter connection kit and a black ABS base.



*Integrated, automatic cover, wooden plant housing,
sand filtration group, and heating*

HEATING

The BWT myPOOL BPNR05 heat pump is ideal for URBAN pools with an air temperature of 15°C, water temperature 26°C. It is delivered with a P-GFI 400, 6m³/h sand filtration group, a by-pass and 9m of piping to allow the heat pump to be installed up to 3.50m from the pool.

ABOVE-GROUND/ PARTIALLY IN-GROUND / IN-GROUND



2 MODELS SQUARE OR RECTANGULAR



STANDARD EQUIPMENT

Description	
Double width pine coping, thickness 28mm, width 290mm	included
Planks of solid, class IV treated Northern Pine, thickness in mm, tolerance + or - 1mm	included
Liner thickness	0.75 mm
Liner colour	Light grey
Number of skimmers P-PM body (colour matched to the liner)	1
Number of return fittings (colour matched to the liner)	1
Hydraulic connections	included
Filtration 4 m ³ /h	see version

Description	
Metallic structural braces	4
LED underwater light	1
Flow rate at the return fitting (m ³ /h)	4
Automatic safety cover	Light grey
Electrical control panel (cover, filtration and UW light)	included
In-pool SS ladder in 2 parts	3 treads
Wooden, safety, access ladder	4 treads
Swim tether	included
Underlay	included

OPTIONAL EQUIPMENT FOR RETROFITTING TO EXISTING POOLS

Code	EAN13	Description	Qty	Unit price	Qty	Unit price	Qty	Unit price
27900320	3566837206369	Filtration cartridge for Urban pools	4	28.10	8	26.70	16	25.29
27900300	3566837170905	Plant housing for in-ground or partially in-ground Urban Pools	1	714.00	2	678.30	4	642.60
27900305	3566837170929	Option: Wooden plant housing and sand filtration, (4m ³ /h)						1,116.00
27900310	3566837170936	Option: Wooden plant housing, sand filtration (6m ³ /h) and heat pump						1,976.00

COMMISSIONING

INFOS A technical team comes to the installation site. The technician installs the liner and the automatic cover on the Urban Pool, without any participation from the end user. The end user must, however, be present on the day of installation.

Code	EAN 13	Description	Net price exVAT.
92250	3566837163884	Urban Pool liner and automatic cover installation service	690.00

URBAN POOLS 4.20M X 3.50M

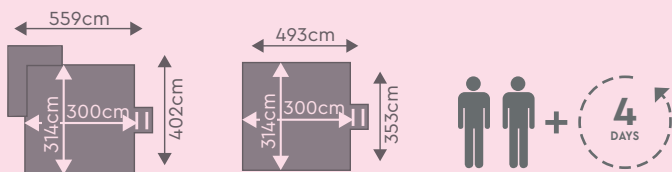

Outer dimensions (cm)	419.2 × 353
Outer dimensions with plant housing (cm)	485.7 × 401.4
Water surface dimensions (cm)	314 × 300
Height, coping included (cm)	133
Water volume (m ³)	13.32
Water surface area (m ²)	9.42

Code	EAN13	Description	Qty	Unit price	Qty	Unit price	Qty	Unit price
27181614	3566837163570	Urban pool 4.20×3.50, GR, Ht:1.33 with automatic cover	1	5,434.00	2	5,162.30	4	4,890.60
27181214	3566837184957	Urban pool 4.20×3.50, GR, Ht:1.33, automatic cover and plant housing	1	6,135.00	2	5,828.25	4	5,521.50
27181314	3566837184971	Urban pool 4.20×3.50, GR, Ht:1.33, automatic cover, plant housing and sand filter	1	6,532.00	2	6,205.40	4	5,878.80
27181414	3566837184988	Urban pool 4.20×3.50, GR, Ht:1.33, automatic cover, plant housing, sand filter and heating	1	7,441.00	2	7,068.95	4	6,696.90

27991901 | Delivery to your door | Transport costs are quoted net of any discount. | POA

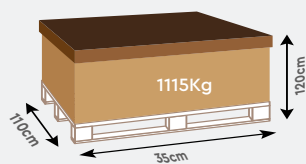

PACKAGING URBAN POOL 4.20 X 3.50 WITH CARTRIDGE FILTER

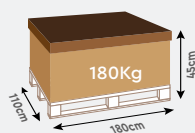

PLANT HOUSING PACKAGING

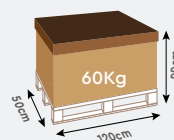

SAND FILTRATION GROUP PACKAGING

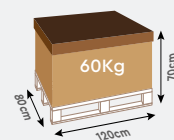

HEAT PUMP PACKAGING

LOGISTICS-DATA

	Code	Urban pool	Plant housing	Sand filter	Heat pump
4.20 x 3.50	27181614	YES	-	-	-
	27181214	YES	YES	-	-
	27181314	YES	YES	YES	-
	27181414	YES	YES	YES	YES



Outer dimensions (cm)	602.9 × 253
Outer dimensions with plant housing (cm)	669.5 × 301.4
Water surface dimensions (cm)	499 × 200
Height, coping included (cm)	133
Water volume (m³)	13.42
Water surface area (m²)	9.99

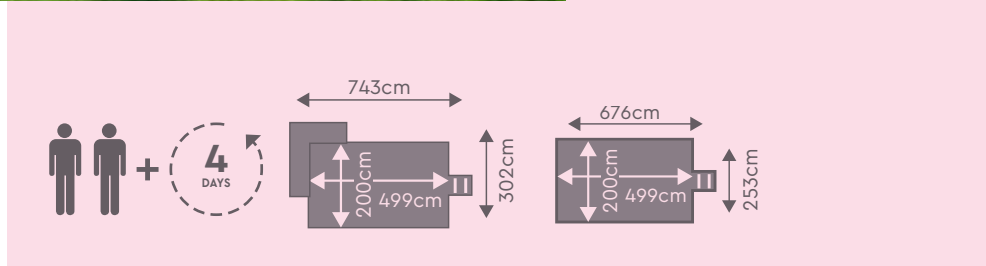

Code	EAN13	Description	Qty	Unit price	Qty	Unit price	Qty	Unit price
27180614	3566837163563	Urban pool 6.00×2.50, GR, Ht:1.33 with automatic cover	1	5,434.00	2	5,162.30	4	4,890.60
27180214	3566837184940	Urban pool 6.00×2.50, GR, Ht:1.33, automatic cover and plant housing	1	6,135.00	2	5,828.25	4	5,521.50
27180314	3566837184964	Urban pool 6.00×2.50, GR, Ht:1.33, automatic cover, plant housing and sand filter	1	6,532.00	2	6,205.40	4	5,878.80
27180414	3566837184995	Urban pool 6.00×2.50, GR, Ht:1.33, automatic cover, plant housing, sand filter and heating	1	7,441.00	2	7,068.95	4	6,696.90

27991902	Delivery to your door	Transport costs are quoted net of any discount.							POA
----------	-----------------------	---	--	--	--	--	--	--	-----

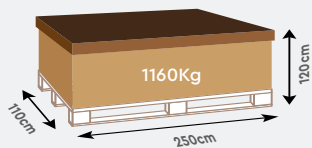

PACKAGING URBAN POOL 6.00 X 2.50 WITH CARTRIDGE FILTER

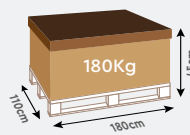

PLANT HOUSING PACKAGING

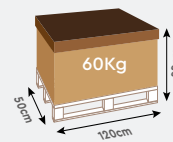

SAND FILTRATION GROUP PACKAGING

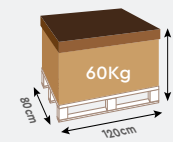

HEAT PUMP PACKAGING

	Code	Urban pool	Plant housing	Sand filter	Heat pump
6.00 x 2.50	27180614	YES	-	-	-
	27180214	YES	YES	-	-
	27180314	YES	YES	YES	-
	27180414	YES	YES	YES	YES

LOGISTICS DATA

LARGE AND WELL EQUIPPED



STRUCTURE
POOL FITTINGS
LINER

AUTOMATIC
COVER

LADDER
FILTRATION



COPING

- » Made of class IV treated pine, thickness 28mm and width 290mm (2 x 145mm).

RETURN FITTINGS AND SKIMMERS

- » 2 return fittings,
- » 2 skimmers.

LADDERS

- » SS in-pool ladder, 3 treads,
- » Wooden access ladder, 4 treads.

LINER

- » 0.75mm liner, light grey

AUTOMATIC COVER

- » Light grey



INTERLOCKING STRUCTURE

- » Class IV treated solid Northern pine, rounded finish,
- » Thickness, 45mm,
- » Galvanised steel supporting braces

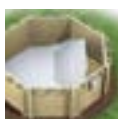

UNDERLAY

- » Underlay to be fitted under the liner

FILTRATION GROUP

- » Sand filtration group, light grey filter P-GFS 500-EH 8m³/h
- » 6-way valve
- » Self-priming pump with pre-filter
- » Pump/ Filter connection kit
- » Black ABS base
- » Delivered with the filter medium



INFOS

In the case of a partially in-ground or in-ground installation, a plant housing is mandatory to provide a dry pit to house the automatic cover motorisation.

Contact your Procopi agency.



INFOS

OPTIONAL EXTRAS

URBAN POOLS XL 6.50 x 3.50m can be fitted with additional equipment such as a heat pump, a salt water electrolyser, year automatic regulation system, etc.

BWT myPOOL Comfortline Inverter heat pumps are listed on pages 38.



INFOS

The filtration group must be installed in a plant housing.

Examples of pine plant housings: see page 26



A LARGE WOODEN POOL WITH AUTOMATIC COVER.

A BLEND OF GENEROUS DIMENSIONS, HIGH-END EQUIPMENT AND CAREFUL CRAFTSMANSHIP BY A FRENCH MANUFACTURER KNOWN FOR THEIR SKILL AND DILIGENCE.

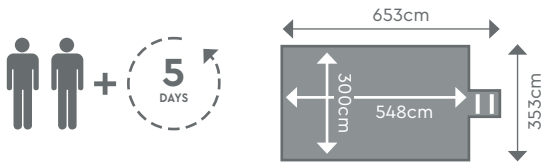

Description	
Outer dimensions (cm)	653 × 353cm
Innder dimensions (cm)	548 × 300cm
Height, coping included (cm)	133cm
Water volume (m ³)	21.89
Water surface area (m ²)	16.44

Code	EAN13	Description	Qty	Unit price	Qty	Unit price	Qty	Unit price
27184218	3566837210922	Wooden pool/auto cover, 6.5×3.5, GR, Ht:133	1	8,475.00	2	8,051.25	4	7,627.50
27900350	3566837228033	Plant housing, for 6.5 × 3.5 Urban Pools	1	278.00	2	264.10	4	250.20

27991200	Delivery of a wooden pool to your door	Transport costs are quoted net of any discount.	POA
----------	--	---	-----



STANDARD EQUIPMENT

HIGH-END EQUIPMENT

- » Automatic slat cover
- » Ready to use, properly sized sand filtration group.

The 6.5 × 3.5m Urban pool XL is fitted with all the equipment it needs to run, as standard

Description	
Metallic structural braces	included
Coping made of class IV treated pine, thickness 28mm and width 290mm (2 × 145mm).	included
Planks of solid, class IV treated Northern Pine, thickness in mm, tolerance + or - 1mm	45
Liner thickness	0.75mm
Liner colour	Light grey
Number of skimmers P-GM Long	2
Number of return fittings	2
Buriable hydraulic fittings, Ø 45mm	included
Sand filter	P-FS 500 EH

Description	
Sand filter diameter (mm)	500
Flow rate at the return fitting (m ³ /h)	9.70
Sand supplied (kg)	75
6-way valve	included
1/4 turn valve, return/ suction	included
In-pool SS ladder	3 treads
Wooden, safety, access ladder	4 treads
Underlay	included
Automatic safety cover	Light grey
Electrical control panel	included

COMMISSIONING

INFOS

A technical team comes to the installation site. The technician installs the liner and the automatic cover on the Urban Pool, without any participation from the end user. The end user must, however, be present on the day of installation.

Code	EAN 13	Description	Net price exVAT.
92250	3566837163884	Urban Pool liner and automatic cover installation service	690,00

INFOS

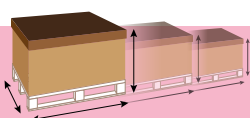

LOGISTICS DATA
PAGE 122

BOXING CLEVER!



RETURN FITTING AND SKIMMER

- » 1 return fitting
- » 1 skimmer P-PM body



LADDERS

- » SS in-pool ladder, 3 treads,
- » Wooden access ladder, 4 treads.

COPING

- » Class IV treated pine, 28mm thick and 195mm wide.

LINER

- » 0.75mm, light grey

LOCKING MECHANISM

- » for total safety.



INFOS

Northern pine: a hard, almost rot-proof wood that grows slowly in sustainably managed Scandinavian forests. The Pool'n Box structure are CTB B+ SP treated, they are guaranteed 10 years.



INTERLOCKING STRUCTURE

- » Solid class IV treated, autoclaved Northern Pine, rounded finish
- » Thickness, 45mm,
- » Galvanised steel supporting braces.



FILTRATION GROUP

- » Flow rate at the return fitting 5.2m³/h (clean filter),
- » Sand filter P-FI, Ø 400, anti-UV treated,
- » 6-way valve; filtration/backwash/rinse/circulation/drain/closed,
- » Filtration pump fitted with a pre-filter; 0.33kW.



UNDERLAY

- » Underlay to be fitted under the liner



POOL'N BOX

Pool'n Box is year elegant, high quality pool, built to last. The ultimate proof: 10 year guarantees on the wooden components and five and two year guarantees on the filtration system.

A CLEVER STORAGE SOLUTION

Pool'n Box is cleverly designed with a storage box tucked under the coping. Pool robot, balls, swimming aids, water toys: all the clutter can be cleared away in the blink of year eye to leave the pool area beautifully tidy.

Even better, **Pool'n Box** is very attractively priced. With **Pool'n Box**, you're boxing clever: DIVE IN!

ADVANTAGES

- » Pool'n Box has a very small footprint so its fits easily into tight spaces.
- » Pool'n Box is equipped with a proper sand filter.
- » No need for plant housing: the filtration system fits into the generously sized integrated box leaving plenty of space for storage.
- » The structure is made of solid Northern Pine, the industry standard, this guarantees a long service life and a sound investment.



INFOS

UNDERWATER LIGHTS OPTIONNEL

SeaMaid LED underwater lights, with white (44100019) or RGB (44072019). These lights can be simply mounted on a 1.5" return fitting. See page 8.

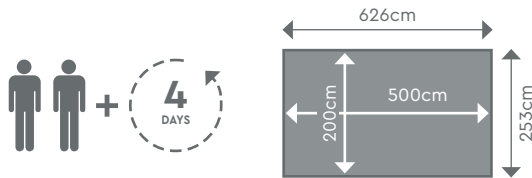

POOL'N BOX, A CLEVER POOL

FAMILY FUN MODE

Toys, rings, floats of every colour thrown everywhere.

NO MORE HOSES CLUTTERING THE LAWN OR TERRACE!

PLEASURE TO BEHOLD, DESIGN MODE

After the fun, return to style and elegance. The pool area is clutter free with no trip hazards! Picture perfect

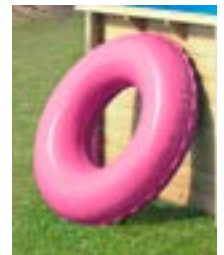

IN THE BLINK OF AN EYE, ALL TIDIED AWAY!

Description	Details
Outer dimensions with box (cm)	610 × 237 cm
Water surface area dimensions (cm)	500 × 200cm
Height coping included (cm)	133cm
Water volume (m ³)	12.2m ³
Water surface area (m ²)	9.99m ²

Code	EAN13	Description	Qty	Unit price	Qty	Unit price	Qty	Unit price
27180018	3566837210915	Wooden pool 5x2 with integrated box, height 133	1	3,719.00	2	3,533.05	4	3,347.10
27991200	Delivery to your door	Transport costs are quoted net of any discount.						POA

STANDARD EQUIPMENT

Description	
Metallic structural braces	included
Coping made of Class IV treated pine, width 195mm	included
Planks of solid, class IV treated Northern Pine, thickness 45 mm	included
Liner thickness	0.75mm
Liner colour	Light grey
Number of skimmers P-PM corps	1
Number of return fittings	2
Buriable hydraulic fittings, Ø 45mm	includede
Sand filter	P-FI

Description	
Sand filter diameter (mm)	400
Hydraulic connections	included
Filtration	4m ³ /h
Sand supplied (kg)	25
6-way valve	included
1/4 turn valve, return/ suction	included
Stainless steel in-pool ladder	3 treads
In-pool SS ladder	4 treads
Underlay	included

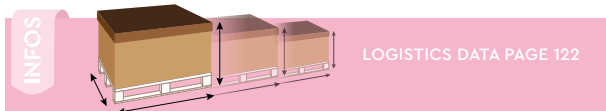

A POOL FOR EVERY-ONE!

COPING

» Class IV treated pine, 28mm thick and 145mm wide

LINER

» 0.50mm, dark blue



CARTRIDGE FILTER



INTERLOCKING STRUCTURE

» Class III and IV treated solid Northern pine
» Thickness, 28 mm,

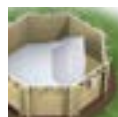

UNDERLAY

» Underlay to be fitted under the liner .

STANDARD EQUIPMENT

Description	
Class IV treated, single width pine coping, thickness in mm, width 145mm	28
Planks of sold class III and class IV treated Northern Pine, thickness in mm, tolerance + or - 1mm	28
Liner thickness	0.50mm
Liner colour	dark blue

Description	
Submerged cartridge filter	included
Underlay	included
Structure guarantee	2 years
Liner guarantee	2 years
Filter guarantee	1 year

PERFECT FOR ANY GARDEN

TROPIC JUNIOR

Particularly well designed, this small above-ground TROPIC JUNIOR pool is practical, robust, beautiful and made in France. With a very small foot print, only 2m x 2 m, it is the perfect size for small children. TROPIC JUNIOR provides fun for the whole family.

TROPIC JUNIOR is packaged in two boxes:

- » Box 1/2 contains the filter cartridge, the 0.50mm dark blue liner and the nuts and bolts.
- » Box 2/2 (pallet) contains the wooden structure.

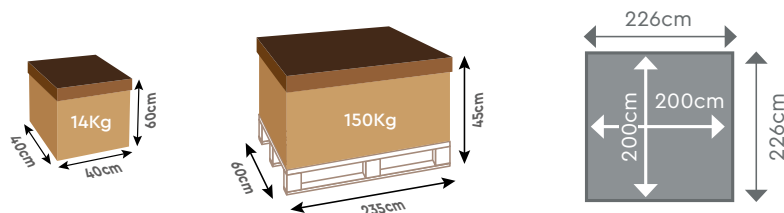

Description	Details
Outer dimensions (cm)	226 × 226cm
Inner dimensions (cm)	200 × 200cm
Height, coping included (cm)	68cm
Water volume (m ³)	2.30
Water surface area (m ²)	4
Packaging	1 box + 1 pallet



Code	EAN13	Description	Qty	Unit price	Qty	Unit price	Qty	Unit price	Qty	Unit price	Qty	Unit price	
27160409	3566837191481	Tropic Junior 2x2x 0.64m	1	586.00	4	544.98	12	539.12	36	533.26	102	527.40	
27991900	3566837159597	Delivery to your door	Transport costs are quoted net of any discount.										70.00

ACCESSORIES

INFOS Pistoche accessories (see the illustrations page 87), are fully compatible with TROPIC JUNIOR pools.

Code	EAN13	Description	Pages
ACCESSORIES AND MAINTENANCE			
27931650	3566837162061	Pistoche spare cartridge	83
27900200	3566837170882	Pistoche cleaning accessories kit	83
27900210	3566837170899	Pistoche pool water treatment kit	83
27900215	3566837175511	Pistoche reversible winter cover (PE 200g/m ²) with 8 eyelets around the periphery	83



THE TROPIC RANGE,

TECHNICAL SPECIFICATIONS



COPING

- » Class IV treated pine, 28mm thick and 195mm wide



LINER

- » 0.50mm liner, dark blue



LADDERS

- » SS in-pool ladder, 3 treads,
- » Wooden access ladder, 4 treads.



RETURN FITTINGS AND SKIMMERS

- » 1 return fitting
- » 1 skimmer P-PM body



FILTRATION GROUP

- » Flow rate at the return fitting 5.2m³/h (clean filter),
- » Sand filter P-FI, Ø 400, anti-UV treated,
- » 6-way valve (filtration/ back-wash/ rinse/ circulation/ drain/closed),
- » Filtration pump fitted with a pre-filter; 0.33kW.



INTERLOCKING STRUCTURE

- » Solid class IV treated, autoclaved Northern Pine, rounded finish
- » Thickness, 45mm,
- » Galvanised steel supporting brace for Octo+ models.



UNDERLAY

- » Underlay to be fitted under the liner .



OPTIONAL UNDERWATER LIGHT:

SeaMaid LED underwater lights, white (44100019) or RGB (44072019). Mounted on a 1.5" return fitting, no building work required. (page 11).

OTHER OPTIONS AVAILABLE:

- » Pine plant housing (page 26),
- » Summer cover (page 58),
- » Winter safety cover (page 62),
- » Bar cover (page 67),
- » Heat pump (page 38),
- » Water treatment (page 42).



*A pool
is not a luxury anymore!*

TROPIC HEXA 410# : (# WHILE STOCKS LAST)

Model	Hexa 410
Supplier reference	27102205
EAN13	3566837114916

Quantity	Unit price
1	2,089.00
2	1,984.55
4	1,880.10

Description	Details
Outer dimensions (cm)	403cm
Inner dimensions (cm)	359cm
Height, coping included (cm)	120cm
Water volume (m ³)	9.15
Water surface area (m ²)	8.11
Packaging	2 pallets

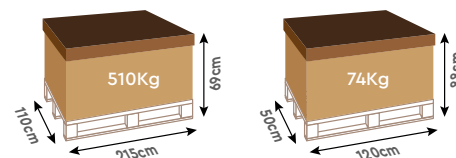
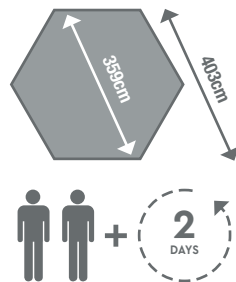

TROPIC OCTO 414

Model	Octo 414
Supplier reference	27111205
EAN13	3566837097264

Quantity	Unit price
1	2,265.00
2	2,151.75
4	2,038.50

Description	Details
Outer dimensions (cm)	414cm
Inner dimensions (cm)	379cm
Height, coping included (cm)	120cm
Water volume (m ³)	11.17
Water surface area (m ²)	9.92
Packaging	2 pallets

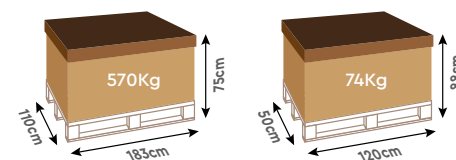
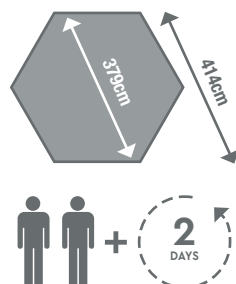

TROPIC OCTO 505

Model	Octo 505
Supplier reference	27112205
EAN13	3566837097271

Quantity	Unit price
1	2,589.00
2	2,459.55
4	2,330.10

Description	Details
Outer dimensions (cm)	505cm
Inner dimensions (cm)	470cm
Height, coping included (cm)	120cm
Water volume (m ³)	17,20
Water surface area (m ²)	15.64
Packaging	2 pallets

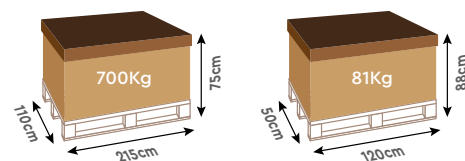
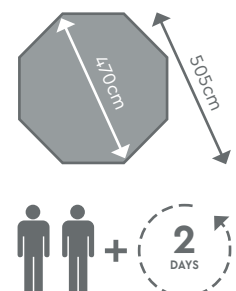

TROPIC OCTO+ 450

Model	Octo+ 450
Supplier reference	27114205
EAN13	3566837097288

Quantity	Unit price
1	2,898.00
2	2,753.10
4	2,608.20

Description	Details
Outer dimensions (cm)	452x313cm
Inner dimensions (cm)	416x277cm
Height, coping included (cm)	120cm
Water volume (m ³)	10.66
Water surface area (m ²)	9.89
Packaging	2 pallets

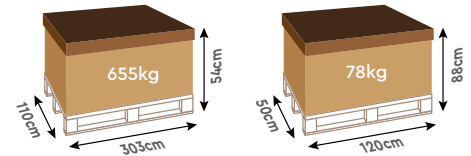
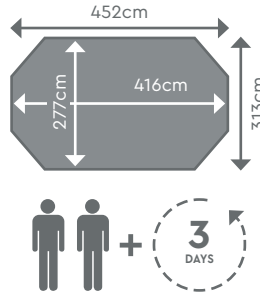

TROPIC OCTO+ 510

Model	Octo+ 510
Supplier reference	27113205
EAN13	3566837113803

Quantity	Unit price
1	2,890.00
2	2,745.50
4	2,601.00

Description	Details
Outer dimensions (cm)	495x345cm
Inner dimensions (cm)	459x309cm
Height, coping included (cm)	120cm
Water volume (m ³)	14,14
Water surface area (m ²)	12,85
Packaging	2 pallets

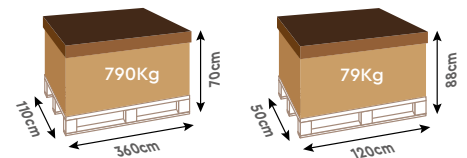
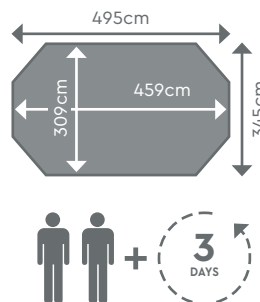

STANDARD EQUIPMENT



STRUCTURE
POOL FITTINGS



FILTER



LADDER
LINER
PUMP



Description	
Single width pine coping, thickness 28mm, width 195mm	included
Planks of solid, class IV treated Northern Pine, thickness in mm, tolerance + or - 1mm	45
Liner thickness	0.50mm
Liner colour	Dark blue
Number of skimmers P-PM body	1
Number of return fittings	1
Hydraulic fittings, 38mm not buriable	included
Sand filter	P-FI

Description	
Sand filter diameter (mm)	400
Flow rate at the return fitting (m ³ /h)	5.20
Sand supplied (kg)	25
6-way valve (filtration, back-wash, rinse, circulation, drain, closed)	included
In-pool stainless steel ladder	3 treads
Wooden, safety, access ladder	4 treads
Underlay	included
Metallic supporting braces	not included except OCTO+

TROPIC OCTO+ 540

Model	Octo+ 540
Supplier reference	27115205
EAN13	3566837106843

Quantity	Unit price
1	3,332.00
2	3,165.40
4	2,998.80

Description	Details
Outer dimensions (cm)	523x313cm
Inner dimensions (cm)	487x277cm
Height, coping included (cm)	120cm
Water volume (m ³)	13.43
Water surface area (m ²)	12.21
Packaging	2 pallets

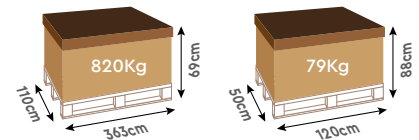
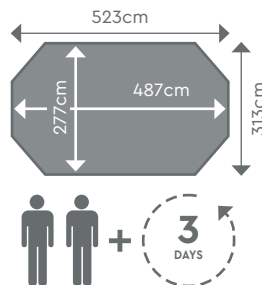

TROPIC OCTO+ 640

Model	Octo+ 640
Supplier reference	27116205
EAN13	3566837101206

Quantity	Unit price
1	3,743.00
2	3,555.85
4	3,368.70

Description	Details
Outer dimensions (cm)	627x386cm
Inner dimensions (cm)	591x350cm
Height, coping included (cm)	120cm
Water volume (m ³)	20.36
Water surface area (m ²)	18.51
Packaging	2 pallets

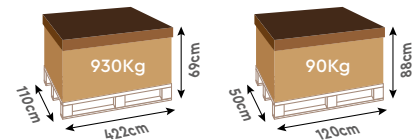
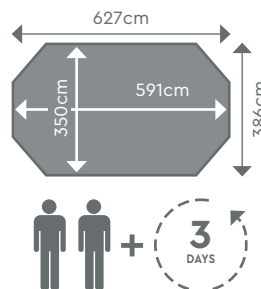



TROPIC POOLS WITH A 60 HZ PUMP

Code	EAN13	Reference	Qty	Price unitaire	Qty	Unit price	Qty	Unit price
27102207	3566837159818	Wooden pool Tropic Hexa, pine, DB, Ht:120, 60hz#	1	2,332.00	2	2,215.40	4	2,098.80
27111207	3566837121082	Wooden pool Tropic 414, pine, DB, Ht:120, 60hz	1	2,510.00	2	2,384.50	4	2,259.00
27112207	3566837121099	Wooden pool Tropic 505, pine, DB, Ht:120, 60hz	1	2,837.00	2	2,695.15	4	2,553.30
27114207	3566837121105	Wooden pool Tropic +460, pine, DB, Ht:115, 60hz	1	2,888.00	2	2,743.60	4	2,599.20
27115207	3566837121112	Wooden pool Tropic +540, pine, DB, Ht:120, 60hz	1	3,576.00	2	3,397.20	4	3,218.40
27116207	3566837121136	Wooden pool Tropic +640, pine, DB, Ht:120, 60hz	1	3,988.00	2	3,788.60	4	3,589.20

white stocks last

STANDARD EQUIPMENT



STRUCTURE
POOL FITTINGS



FILTER



LADDER
LINER
PUMP

Description	
Single width pine coping, thickness 28mm, width 195mm	included
Planks of solid, class IV treated Northern Pine, thickness in mm, tolerance + or - 1mm	45
Liner thickness	0.50mm
Liner colour	Dark blue
Number of skimmers P-PM body	1
Number of return fittings	1
Hydraulic fittings, 38mm not buriable	included
Sand filter	P-FI

Description	
Sand filter diameter (mm)	400
Flow rate at the return fitting (m ³ /h)	5.20
Sand supplied (kg)	25
6-way valve (filtration, back-wash, rinse, circulation, drain, closed)	included
In-pool stainless steel ladder	3 treads
Wooden, safety, access ladder	4 treads
Underlay	included
Metallic supporting braces	not included except OCTO+

TECHNICAL SPECIFICATIONS

THE WEVA RANGE



LADDERS

- » SS in-pool ladder, 3 treads,
- » Wooden access ladder, 4 to 5 treads.



COPING

- » Made of class IV treated pine, thickness 28mm and width 290mm (2 x 145mm).

LINER

- » 0.75mm liner, Dark blue



RETURN FITTINGS AND SKIMMERS

- » 1 or 2 return fitting(s)
- » 1 or 2 skimmer(s)



FILTRATION GROUP

- » Flow rate 7.90 to 9.70m³/h at the return fitting outlet(s) (depending on the model),
- » Sand filter, Ø 500 (P-FI or P-FS depending on the model), anti-UV treated
- » 6-way valve (filtration/back wash/rinse/circulation/drain/closed)
- » Isolating valves on the return and suction lines,
- » Filtration pump fitted with a prefilter; power 0.46 to 0.60kW,
- » Semi-rigid, buriable hydraulic fittings, Ø 45mm.



INTERLOCKING STRUCTURE

- » Class IV treated Northern pine, rounded finish
- » Thickness, 45mm,
- » Galvanised steel supporting brace for elongated octagonal, square and rectangular pool models.



UNDERLAY

- » Underlay to be laid under the liner.

INFOS

**OPTIONAL UNDERWATER LIGHT:**

SeaMaid LED underwater lights, white (44100019) or RGB (44072019). Mounted on a 1.5" return fittings, no building work required. (page 11).

OTHER AVAILABLE OPTIONS:

- » Counter-swim units (page 34),
- » Delta MS drainage membrane (page 26),
- » Pine plant housing (page 26),
- » Automatic cover (page 54),
- » Summer cover (page 59),
- » Safety winter cover (page 62),
- » Bar covers (page 66),
- » Heat pump (page 38),
- » Water treatment (page 42).



*A hassle-free, practical range!
The accessible dream!*



WEVA OCTO 530

Model	Octo 530	Quantity	Unit price	Description	Details
Supplier reference	27122210	1	3,438.00	Outer dimensions (cm)	528cm
EAN13	3566837096830	2	3,266.10	Inner dimensions (cm)	470cm
		4	3,094.20	Height, coping included (cm)	133cm
				Water volume (m ³)	18.77
				Water surface area (m ²)	15.64
				Packaging	2 pallets

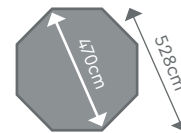

STANDARD EQUIPMENT

INFOS

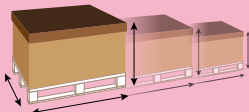

LOGISTICS DATA PAGE 122



STRUCTURE
POOL FITTINGS



FILTER



LADDER
PUMP
LINER



Description	
Metallic structural braces	Not included except Octo+
Coping made of class IV treated pine, thickness 28mm and width 290mm (2 x 145mm).	included
Planks of solid, class IV treated Northern Pine, thickness in mm, tolerance + or - 1mm	45
Liner thickness	0.75mm
Liner colour	Dark blue
Number of skimmers P-PM body	1
Number of return fittings	1
Buriable hydraulic fittings, Ø 45mm	included
Sand filter	P-FI
Sand filter diameter (mm)	500

Description	
Débit à la Return fitting (m ³ /h)	Octo - 7.90 Octo+ - 8.30
Sand supplied (kg)	50
6-way valve (filtration/ backwash/ rinse/ circulation/ drain/ closed)	included
1/4 turn valve, return/ suction	included
In-pool SS ladder	3 treads
Wooden, safety, access ladder	4 treads 5 treads for coping height 146
Underlay	included

ABOVE-GROUND/ PARTIALLY IN-GROUND / IN-GROUND

WEVA OCTO+ 640

Model	Octo+ 640	Quantity	Unit price	Description	Details
Supplier reference	27126210	1	4 705.00	Outer dimensions (cm)	644×404cm
EAN13	3566837096892	2	4 469.75	Inner dimensions (cm)	590×350cm
		4	4 234.50	Height, coping included (cm)	133cm
				Water volume (m ³)	22.40
				Water surface area (m ²)	18.51
				Packaging	2 pallets

Model	Octo+ 640	Quantity	Unit price	Description	Details
Supplier reference	27136210	1	4,950.00	Outer dimensions (cm)	644×404cm
EAN13	3566837096960	2	4,702.50	Inner dimensions (cm)	590×350cm
		4	4,455.00	Height, coping included (cm)	146cm
				Water volume (m ³)	24.62
				Water surface area (m ²)	18.51
				Packaging	2 pallets

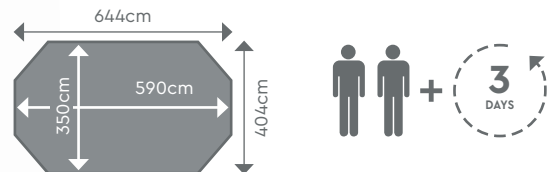

WEVA OCTO+ 840

Model	Octo+ 840	Quantity	Unit price	Description	Details
Supplier reference	27128210	1	6,051.00	Outer dimensions (cm)	843×489cm
EAN13	3566837096977	2	5,748.45	Inner dimensions (cm)	789×435cm
		4	5,445.90	Height, coping included (cm)	133cm
				Water volume (m ³)	37.53
				Water surface area (m ²)	31.02
				Packaging	2 pallets

Model	Octo+ 840	Quantity	Unit price	Description	Details
Supplier reference	27138210	1	6,333.00	Outer dimensions (cm)	843×489cm
EAN13	3566837096908	2	6,016.35	Inner dimensions (cm)	789×435cm
		4	5,699.70	Height, coping included (cm)	146cm
				Water volume (m ³)	41.25
				Water surface area (m ²)	31.02
				Packaging	2 pallets

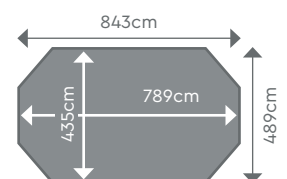



WEVA SQUARE 3X3

Model	Square 3x3	Quantity	Unit price	Description	Details
Supplier reference	27172211	1	3,770.00	Outer dimensions (cm)	353cm
EAN13	3566837114923	2	3,581.50	Inner dimensions (cm)	300cm
		4	3,393.00	Height, coping included (cm)	120cm
				Water volume (m ³)	9.90
				Water surface area (m ²)	9.00
				Packaging	3 pallets

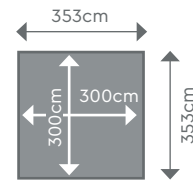

STANDARD EQUIPMENT

INFOS

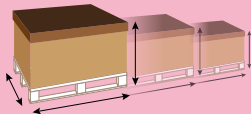

LOGISTICS DATA PAGE 127



STRUCTURE
POOL FITTINGS



FILTER



LADDER
PUMP
LINER



Description	
Metallic structural braces	included
Made of class IV treated pine, thickness 28mm and width 290mm (2 x 145mm)	included
Planks of solid, class IV treated Northern Pine, thickness in mm, tolerance + or - 1mm	45
Liner thickness	0.75mm
Liner colour	Dark blue
Number of skimmers P-GM Long	1 - square 2 -rectangular
Number of return fittings	1 - square 2 -rectangular
Buriable hydraulic fittings, Ø 45mm	included
Sand filter	P-FS

Description	
Sand filter diameter (mm)	500 EH
Flow rate at the return fitting (m ³ /h)	9.70
Sand supplied (kg)	75
6-way valve (filtration/ backwash/ rinse/ circulation/ drain/ closed)	included
1/4 turn valve, return/ suction	included
In-pool SS ladder	3 treads
Wooden, safety, access ladder	4 treads h: 1.20 or 1.33 5 treads - h: 1.46
Underlay	included

ABOVE-GROUND/ PARTIALLY IN-GROUND / IN-GROUND

WEVA RECTANGLE 6X3

Model	Rectangular 6x3
Supplier reference	27184210
EAN13	3566837096984

Quantity	Unit price
1	5,800.00
2	5,510.00
4	5,220.00

Description	Details
Outer dimensions (cm)	653x353cm
Inner dimensions (cm)	600x300cm
Height, coping included (cm)	133cm
Water volume (m ³)	21.78
Water surface area (m ²)	18.00
Packaging	4 pallets

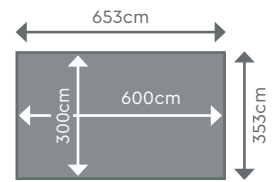

WEVA RECTANGLE 8X4

Model	Rectangular 8x4
Supplier reference	27196210
EAN13	3566837096991

Quantity	Unit price
1	8,131.00
2	7,724.45
4	7,317.90

Description	Details
Outer dimensions (cm)	853x453cm
Inner dimensions (cm)	800x400cm
Height, coping included (cm)	146cm
Water volume (m ³)	42.56
Water surface area (m ²)	32.00
Packaging	5 pallets

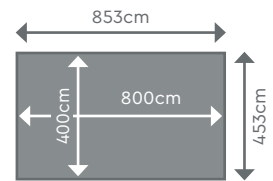

WEVA POOLS WITH 60 HZ PUMPS - OCTO, OCTO+

Code	EAN13	Description	Qty	Price	Qty	Price	Qty	Price
27122212	3566837121143	Wooden pool Weva 530, pine, DB, Ht:133, 60 HZ	1	3,725.00	2	3,538.75	4	3,352.50
27126212	3566837121167	Wooden pool Weva +640, pine, DB, Ht:133, 60 HZ	1	5,079.00	2	4,825.05	4	4,571.10
27136212	3566837121174	Wooden pool Weva +640, pine, DB, Ht:146, 60 HZ	1	5,351.00	2	5,083.45	4	4,815.90
27128212	3566837121181	Wooden pool Weva +840, pine, DB, Ht:133, 60 HZ	1	6,459.00	2	6,136.05	4	5,813.10
27138212	3566837121198	Wooden pool Weva +840, pine, DB, Ht:146, 60 HZ	1	6,751.00	2	6,413.45	4	6,075.90

STANDARD EQUIPMENT

INFOS

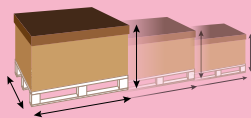

LOGISTICS DATA PAGE 122



STRUCTURE POOL FITTINGS



FILTER



LADDER PUMP LINER



Description	
Metallic structural braces	Not included except Octo+
Made of class IV treated pine, thickness 28mm and width 290mm (2 x 145mm).	included
Planks of solid, class IV treated Northern Pine, thickness in mm, tolerance + or - 1mm	45
Liner thickness	0.75mm
Liner colour	Dark blue
Number of skimmers P-SM body	1
Number of return fittings	1
Buriable hydraulic fittings, Ø 45mm	included
Sand filter	P-FI

Description	
Sand filter diameter (mm)	500
Flow rate at the return fitting (m³/h)	Octo - 7.90 Octo+ - 8.30
Sand supplied (kg)	50
6-way valve (filtration/ backwash/rinse/ circulation/ drain/ closed)	included
1/4 turn valve, return/ suction	included
In-pool SS ladder	3 treads
Wooden, safety, access ladder	4 treads 5 treads for coping height 146
Underlay	included





WEVA POOLS WITH 60 HZ PUMPS - SQUARE, RECTANGULAR

Code	EAN13	Description	Qty	Price	Qty	Price	Qty	Price
27172213	3566837161460	Weva wooden pool 3 x 3, pine, dark blue, H=120, 60 Hz	1	4,065.00	2	3,861.75	4	3,658.50
27184212	3566837121242	Weva wooden pool 6 x 3, pine, dark blue, H=133, 60 Hz	1	6,218.00	2	5,907.10	4	5,596.20
27196212	3566837121204	Weva 8 x 4 wooden pool, pin, dark blue, H=146, 60 Hz	1	8,611.00	2	8,180.45	4	7,749.90

STANDARD EQUIPMENT

INFOS

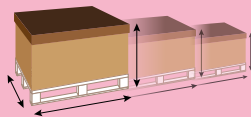

LOGISTICS DATA PAGE 122



STRUCTURE
POOL FITTINGS



FILTER



LADDER
PUMP
LINER



Description	
Metallic structural braces	included
Coping double pin, épaisseur 28mm, largeur 290mm (2 x 145mm)	included
Planks of solid, class IV treated Northern Pine, thickness in mm, tolerance + or - 1mm	45
Liner thickness	0.75mm
Liner colour	Dark blue
Number of skimmers P-GM Long	2
Number of return fittings	1 - square 2 - rectangular
Buriable hydraulic fittings, Ø 45mm	included

Description	
Sand filter	P-FS
Sand filter diameter (mm)	500 EH
Flow rate at the return fitting (m ³ /h)	9.70
Sand supplied (kg)	75
6-way valve (filtration/ backwash/ rinse/ circulation/ drain/ closed)	included
1/4 turn valve, return/ suction	included
In-pool SS ladder	3 treads
Wooden, safety, access ladder	4 treads h: 1,20x1,33 5 treads - h: 1.46
Underlay	included

TECHNICAL SPECIFICATIONS

THE ODYSSEY RANGE

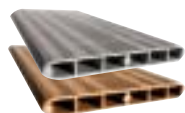

COPING

- » Coastal Grey or Havana composite wood coping, thickness 35mm and width 285mm.



BUBBLE COVER

- » An isothermal cover that helps prevent evaporation and maintain water temperature.

LADDERS

- » SS in-pool ladder, 3 treads,
- » Wooden access ladder, 4 to 5 treads.

LINER

- » 0.75mm liner, Dark Blue, Beige, Grey.



POOL FITTINGS THAT MATCH THE LINER

- » 1 or 2 return fitting(s),
- » 1 or 2 skimmer(s),
- » 1 vacuum point.



UNDERWATER LIGHTS

- » 2 halogen underwater lights, 50W, 1 electrical panel.



FILTRATION GROUP

- » Flow rate at the return fitting(s) 9.10m³/h,
- » P-FS filter, Ø 500 EH, anti-UV treated,
- » 6-way valve (filtration/back wash/rinse/circulation/drain/closed)
- » Isolating valves on the return and suction lines,
- » Filtration pump fitted with a prefilter; power 0.60kW,
- » Semi-rigid, buriable hydraulic fittings, Ø 45mm.



INTERLOCKING STRUCTURE

- » Made of solid class IV treated Northern Pine, 45mm thick with a rounded finish,
- » Galvanised steel supporting brace for elongated octagonal, square and rectangular pool models.

DECHLORINATOR

- » Ecological, it dechlorinates backwash water.



UNDERLAY

- » Underlay to be fitted under the liner.

INFOS

**OPTIONAL UNDERWATER LIGHT:**

SeaMaid LED underwater lights, white (44100019) or RGB (44072019). Mounted on a 1.5" return fittings, no building work required. (page 8).

OTHER AVAILABLE OPTIONS:

- » Counter-swim unit (page 34),
- » Delta MS drainage membrane (page 26),
- » Pine plant housing (page 26),
- » Automatic cover (page 55),
- » Summer cover (page 56),
- » Winter safety cover (page 60),
- » Bar cover (page 65),
- » Heat pump (page 38),
- » Water treatment (page 42).



*Pools with a wide selection of finishes,
and a broad range of fittings!*

ODYSSEA OCTO 530

Model	Octo 530
Supplier reference	27222215
EAN13	3566837097042

Quantity	Unit price
1	5,199.00
2	4,939.05
4	4,679.10

Description	Details
Outer dimensions (cm)	525cm
Inner dimensions (cm)	470cm
Height, coping included (cm)	133cm
Water volume (m ³)	18.77
Water surface area (m ²)	15.64
Packaging	5 pallets
Coping colour	havana
Liner colour	Dark blue

Model	Octo 530
Supplier reference	27222515
EAN13	3566837097059

1	5,199.00
2	4,939.05
4	4,679.10

Description	Details
Coping colour	havana
Liner colour	Beige*

Model	Octo 530
Supplier reference	27322615
EAN13	3566837097066

1	5,199.00
2	4,939.05
4	4,679.10

Description	Details
Coping colour	Coastal Grey
Liner colour	Light grey*

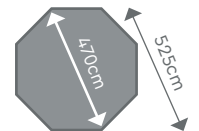

STANDARD EQUIPMENT

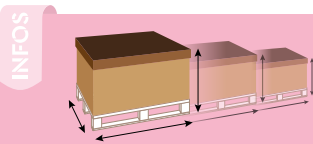

LOGISTICS DATA PAGE 122



STRUCTURE
POOL FITTINGS



FILTER



LADDER
PUMP
LINER



Description	
Coping made of composite wood, thickness 35mm, width 285mm	
Planks of solid, class IV treated Northern Pine, thickness in mm, tolerance + or - 1mm	45
Liner thickness	0.75mm
Liner colours - Dark Blue, Beige* or Light Grey*	
Number of skimmers P-SM body (matching the liner)	1
Number of return fittings (matching the liner)	1
Number of vacuum fittings (matching the liner)	1
Buriable hydraulic fittings, Ø 45mm	included
Sand filter	P-FS
Sand filter diameter (mm)	500 EH
Flow rate at the return fitting (m ³ /h)	9.10

Description	
Sand supplied (kg)	75
6-way valve (filtration/ backwash/ rinse/ circulation/ drain/ closed)	included
1/4 turn valve, return/ suction	included
In-pool SS ladder	3 treads
Wooden, safety, access ladder	4 treads
Underlay	included
Bubble cover	280 µ
Electrical panel with protection	1
50W halogen underwater light (PAR56)	2
Dechlorinator	included

*Pools fitted with beige or grey liners are subject to an additional delivery lead time of 2 weeks.



ODYSSEA OCTO+ 640

Model	Octo+ 640	Quantity	Unit price	Description	Details
Supplier reference	27226215	1	6,574.00	Outer dimensions (cm)	643×403cm
EAN13	3566837097097	2	6,245.30	Inner dimensions (cm)	590×350cm
		4	5,916.60	Height, coping included (cm)	133cm
				Water volume (m ³)	22.40
				Water surface area (m ²)	18.51
				Packaging	5 pallets
				Coping colour	havana
				Liner colour	Dark blue

Model	Octo+ 640	Quantity	Unit price	Description	Details
Supplier reference	27226515	2	6,245.30	Coping colour	havana
EAN13	3566837096878	4	5,916.60	Liner colour	beige*

Model	Octo+ 640	Quantity	Unit price	Description	Details
Supplier reference	27326615	2	6,245.30	Coping colour	Coastal Grey
EAN13	3566837097103	4	5,916.60	Liner colour	Light grey*

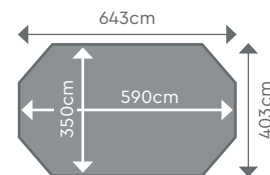

INFOS

LOGISTICS DATA PAGE 122

10 YEARS GUARANTEE
BWT myPOOL
STRUCTURE
POOL FITTINGS

5 YEARS GUARANTEE
BWT myPOOL
FILTER

2 YEARS GUARANTEE
BWT myPOOL
LADDER
PUMP
LINER

STANDARD EQUIPMENT

Description	Quantity
Metallic structural braces	4
Coping made of composite wood, thickness 35mm, width 285mm	
Planks of solid, class IV treated Northern Pine, thickness in mm, tolerance + or - 1mm	45
Liner thickness	0.75mm
Liner colours - Dark Blue, Beige* or Light Grey*	
Number of skimmers P-PM Long (matching the liner)	1
Number of return fittings (matching the liner)	1
Number of vacuum fittings (matching the liner)	1
Buriable hydraulic fittings, Ø 45mm	included
Sand filter	P-FS
Sand filter diameter (mm)	500 EH

Description	Quantity
Flow rate at the return fitting (m ³ /h)	9.10
Sand supplied (kg)	75
6-way valve (filtration/ backwash/ rinse/ circulation/ drain/ closed)	included
1/4 turn valve, return/ suction	included
In-pool SS ladder	3 treads
Wooden, safety, access ladder	4 treads
Underlay	included
Bubble cover	280 µ
Electrical panel with protection	1
50W halogen underwater light (PAR56)	2
Dechlorinator	included

* Pools fitted with beige or grey liners are subject to an additional delivery lead time of 2 weeks.

ABOVE-GROUND/ PARTIALLY IN-GROUND / IN-GROUND

ODYSSEA OCTO+ 640

Model	Octo+ 640	Quantity	Unit price	Description	Details
Supplier reference	27236215	1	6,814.00	Outer dimensions (cm)	643x403cm
EAN13	3566837096885	2	6,473.30	Inner dimensions (cm)	590x350cm
		4	6,132.60	Height, coping included (cm)	146cm
				Water volume (m ³)	24.62
				Water surface area (m ²)	18.51
				Packaging	5 pallets
				Coping colour	havana
				Liner colour	Dark blue

Model	Octo+ 640	Quantity	Unit price	Description	Details
Supplier reference	27236515	2	6,473.30	Coping colour	havana
EAN13	3566837097110	4	6,132.60	Liner colour	beige*

Model	Octo+ 640	Quantity	Unit price	Description	Details
Supplier reference	27336615	2	6,473.30	Coping colour	Coastal Grey
EAN13	3566837097127	4	6,132.60	Liner colour	Light grey*

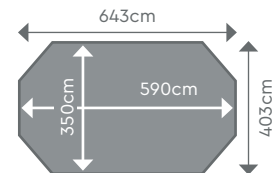

INFOS

LOGISTICS DATA PAGE 122

10 YEARS GUARANTEE
STRUCTURE POOL FITTINGS

5 YEARS GUARANTEE
FILTER

2 YEARS GUARANTEE
LADDER PUMP LINER

STANDARD EQUIPMENT

Description	Quantity
Metallic structural braces	4
Coping made of composite wood, thickness 35mm, width 285mm	
Planks of solid, class IV treated Northern Pine, thickness in mm, tolerance + or - 1mm	45
Liner thickness	0.75mm
Liner colours – Dark Blue, Beige* or Light Grey*	
Number of skimmers P-PM Long (matching the liner)	1
Number of return fittings (matching the liner)	1
Number of vacuum fittings (matching the liner)	1
Buriable hydraulic fittings, Ø 45mm	included
Sand filter	P-FS
Sand filter diameter (mm)	500 EH

Description	Quantity
Flow rate at the return fitting (m ³ /h)	9.10
Sand supplied (kg)	75
6-way valve (filtration/ backwash/ rinse/ circulation/ drain/ closed)	included
1/4 turn valve, return/ suction	included
In-pool SS ladder	3 treads
Wooden, safety, access ladder	5 treads
Underlay	included
Bubble cover	280 µ
Electrical panel with protection	1
50W halogen underwater light (PAR56)	2
Dechlorinator	included

* Pools fitted with beige or grey liners are subject to an additional delivery lead time of 2 weeks.

ODYSSEA OCTO+ 840

Model	Octo+ 840	Quantity	Unit price	Description	Details
Supplier reference	27228215	1	8,151.00	Outer dimensions (cm)	842x488cm
EAN13	3566837096915	2	7,743.45	Inner dimensions (cm)	789x435cm
		4	7,335.90	Height, coping included (cm)	133cm
				Water volume (m ³)	37.53
				Water surface area (m ²)	31.08
				Packaging	4 pallets
				Coping colour	havana
				Liner colour	Dark blue

Model	Octo+ 840	Quantity	Unit price	Description	Details
Supplier reference	27228515	2	7,743.45	Coping colour	havana
EAN13	3566837096922	4	7,335.90	Liner colour	beige*

Model	Octo+ 840	Quantity	Unit price	Description	Details
Supplier reference	27328615	2	7,743.45	Coping colour	Coastal Grey
EAN13	3566837097165	4	7,335.90	Liner colour	Light grey*

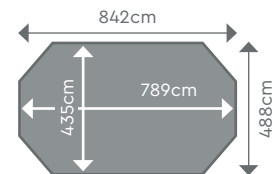

INFOS

LOGISTICS DATA PAGE 122

10 YEARS GUARANTEE
STRUCTURE POOL FITTINGS

5 YEARS GUARANTEE
FILTER

2 YEARS GUARANTEE
LADDER PUMP LINER

STANDARD EQUIPMENT

Description	Quantity
Metallic structural braces	6
Coping made of composite wood, thickness 35mm, width 285mm	
Planks of solid, class IV treated Northern Pine, thickness in mm, tolerance + or - 1mm	45
Liner thickness	0.75mm
Liner colours - Dark Blue, Beige* or Light Grey*	
Number of skimmers P-PM Long (matching the liner)	1
Number of return fittings (matching the liner)	1
Number of vacuum fittings (matching the liner)	1
Buriable hydraulic fittings, Ø 45mm	included
Sand filter	P-FS
Sand filter diameter (mm)	500 EH

Description	Quantity
Débit à la Return fitting (m ³ /h)	9.10
Sand supplied (kg)	75
6-way valve (filtration/ backwash/ rinse/ circulation/ drain/ closed)	included
1/4 turn valve, return/ suction	included
In-pool SS ladder	3 treads
Wooden, safety, access ladder	4 treads
Underlay	included
Bubble cover	280 µ
Electrical panel with protection	1
50W halogen underwater light (PAR56)	2
Dechlorinator	included

* Pools fitted with beige or grey liners are subject to an additional delivery lead time of 2 weeks.

ABOVE-GROUND/ PARTIALLY IN-GROUND / IN-GROUND

ODYSSEA OCTO+ 840

Model	Octo+ 840	Quantity	Unit price	Description	Details
Supplier reference	27238215	1	8,475.00	Outer dimensions (cm)	842x488cm
EAN13	3566837097141	4	8,051.25	Inner dimensions (cm)	789x435cm
		4	7,627.50	Height, coping included (cm)	146cm
				Water volume (m ³)	41.25
				Water surface area (m ²)	31.08
				Packaging	5 pallets
				Coping colour	havana
				Liner colour	Dark blue

Model	Octo+ 840	Quantity	Unit price	Description	Details
Supplier reference	27238515	2	8,051.25	Coping colour	havana
EAN13	3566837097158	4	7,627.50	Liner colour	beige*

Model	Octo+ 840	Quantity	Unit price	Description	Details
Supplier reference	27338615	2	8,051.25	Coping colour	gris côtier
EAN13	3566837097134	4	7,627.50	Liner colour	Light grey*

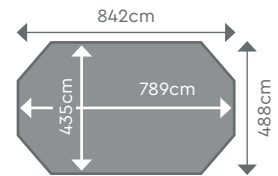

INFOS

LOGISTICS DATA PAGE 122

10 YEARS GUARANTEE
STRUCTURE POOL FITTINGS

5 YEARS GUARANTEE
FILTER

2 YEARS GUARANTEE
LADDER PUMP LINER

STANDARD EQUIPMENT

Description	Quantity
Metallic structural braces	6
Coping made of composite wood, thickness 35mm, width 285mm	
Planks of solid, class IV treated Northern Pine, thickness in mm, tolerance + or - 1mm	45
Liner thickness	0.75mm
Liner colours – Dark Blue, Beige* or Light Grey*	
Number of skimmers P-PM Long (matching the liner)	1
Number of return fittings (matching the liner)	1
Number of vacuum fittings (matching the liner)	1
Hydraulic connections en 45mm enterrable	included
Sand filter	P-FS
Sand filter diameter (mm)	500 EH

Description	Quantity
Flow rate at the return fitting (m ³ /h)	9.10
Sand supplied (kg)	75
6-way valve (filtration/ backwash/ rinse/ circulation/ drain/ closed)	included
1/4 turn valve, return/ suction	included
In-pool SS ladder	3 treads
Wooden, safety, access ladder	5 treads
Underlay	included
Bubble cover	280 μ
Electrical panel with protection	1
50W halogen underwater light (PAR56)	2
Dechlorinator	included

* Pools fitted with beige or grey liners are subject to an additional delivery lead time of 2 weeks.

ODYSSEA RECTANGLE 6X3

Model	Rectangle 6x3	Quantity	Unit price	Description	Details
Supplier reference	27284215	1	7,932.00	Outer dimensions (cm)	653x353cm
EAN13	3566837097172	2	7,535.40	Inner dimensions (cm)	600x300cm
		4	7,138.80	Height, coping included (cm)	133cm
				Water volume (m ³)	21.78
				Water surface area (m ²)	18.00
				Packaging	7 pallets
				Coping colour	havana
				Liner colour	Dark blue

Model	Rectangle 6x3	Quantity	Unit price	Description	Details
Supplier reference	27284515	1	7,932.00	Coping colour	havana
EAN13	3566837097189	2	7,535.40	Liner colour	beige*
		4	7,138.80		

Model	Rectangle 6x3	Quantity	Unit price	Description	Details
Supplier reference	27384615	1	7,932.00	Coping colour	Coastal Grey
EAN13	3566837097196	2	7,535.40	Liner colour	Light grey*
		4	7,138.80		

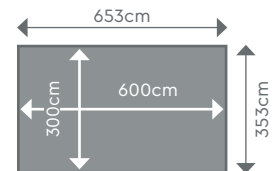

INFOS

LOGISTICS DATA PAGE 122

10 YEARS GUARANTEE
STRUCTURE POOL FITTINGS

5 YEARS GUARANTEE
FILTER

2 YEARS GUARANTEE
LADDER PUMP LINER

STANDARD EQUIPMENT

Description	Quantity
Metallic structural braces	8
Coping made of composite wood, thickness 35mm, width 285mm	
Planks of solid, class IV treated Northern Pine, thickness in mm, tolerance + or - 1mm	45
Liner thickness	0.75mm
Liner colours – Dark Blue, Beige* or Light Grey*	
Number of skimmers P-GM Long (matching the liner)	2
Number of return fittings (matching the liner)	2
Number of vacuum fittings (matching the liner)	1
Buriable hydraulic fittings, Ø 45mm	included
Sand filter	P-FS
Sand filter diameter (mm)	500 EH

Description	Quantity
Flow rate at the return fitting (m ³ /h)	9.80
Sand supplied (kg)	75
6-way valve (filtration/ backwash/ rinse/ circulation/ drain/ closed)	included
1/4 turn valve, return/ suction	included
In-pool SS ladder	3 treads
Wooden, safety, access ladder	4 treads
Underlay	included
Bubble cover	280 µ
Electrical panel with protection	1
50W halogen underwater light (PAR56)	2
Dechlorinator	included

ABOVE-GROUND/ PARTIALLY IN-GROUND / IN-GROUND

ODYSSEA RECTANGLE 8X4

Model	Rectangle 8x4	Quantity	Unit price	Description	Details
Supplier reference	27296215	1	10,565.00	Outer dimensions (cm)	853x453cm
EAN13	3566837097202	2	10,036.75	Inner dimensions (cm)	800x400cm
		4	9,508.50	Height, coping included (cm)	146cm
				Water volume (m ³)	42,56
				Water surface area (m ²)	32,00
				Packaging	8 pallets
				Coping colour	havana
				Liner colour	Dark blue

Model	Rectangle 8x4	Quantity	Unit price	Description	Details
Supplier reference	27296515	2	10,036.75	Coping colour	havana
EAN13	3566837097219	4	9,508.50	Liner colour	beige*

Model	Rectangle 8x4	Quantity	Unit price	Description	Details
Supplier reference	27396615	2	10,036.75	Coping colour	Coastal Grey
EAN13	3566837097226	4	9,508.50	Liner colour	Light grey*

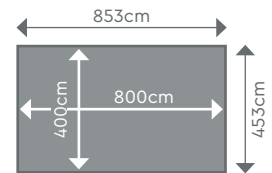

INFOS

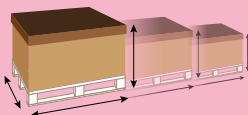

LOGISTICS DATA PAGE 122



STRUCTURE POOL FITTINGS



FILTER



LADDER PUMP LINER



STANDARD EQUIPMENT

Description	
Metallic structural braces	14
Coping made of composite wood, thickness 35mm, width 285mm	
Planks of solid, class IV treated Northern Pine, thickness in mm, tolerance + or - 1mm	45
Liner thickness	75/100 ^{ème}
Liner colours – Dark Blue, Beige* or Light Grey*	
Number of skimmers P-GM long (matching the liner)	2
Number of return fittings (matching the liner)	2
Number of vacuum fittings (matching the liner)	1
Buriable hydraulic fittings, Ø 45mm	included
Sand filter	P-FS

Description	
Sand filter diameter (mm)	500 EH
Flow rate at the return fitting (m ³ /h)	9,80
Sand supplied (kg)	75
6-way valve (filtration/ backwash/ rinse/ circulation/ drain/ closed)	included
1/4 turn valve, return/ suction	included
In-pool SS ladder	3 treads
Wooden, safety, access ladder	5 treads
Underlay	included
Bubble cover	280 µ
Electrical panel with protection	1
50W halogen underwater light (PAR56)	2
Dechlorinator	included

WOODEN POOL PACKAGING DATA

Code	Model	Pack	Length (cm)	Width (cm)	Height (cm)	Weight (kg)	Total weight (kg)
27160209	Pistoche wooden pool, 2x2, dak blue	Wooden elements	235	60	45	152	166
		Accessories	40	40	60	14	
27160409	Tropic Junior wooden pool, 2mx2m, dark blue	Wooden elements	235	60	45	134	148
		Accessories	40	40	60	14	
URBAN POOLS							
27181614	Urban pool 4.20x3.50, GR, Ht:1.33, auto cover	Wooden elements	350	110	120	1,115	1,115
27181214	Urban pool 4.20x3.50, GR, Ht:1.33, plant housing	Wooden elements	350	110	120	1,115	1,295
		Plant housing	180	110	45	180	
27181314	Urban pool 4.20x3.50, GR, Ht:1.33, filtration	Wooden elements	350	110	120	1,115	1,355
		Plant housing	180	110	45	180	
		Filtration	120	50	90	60	
27181414	Urban pool 4.20x3.50, GR, Ht:1.33, heating	Wooden elements	350	110	120	1,115	1,415
		Plant housing	180	110	45	180	
		filtration	120	50	90	60	
		Heat pump	120	80	70	60	
27180614	Urban pool 6.00x2.50, GR, Ht:1.33, auto cover	Wooden elements	250	110	120	1,160	1,160
27180214	Urban pool 6.00x2.50, GR, Ht:1.33, plant housing	Wooden elements	250	110	120	1,160	1,340
		Plant housing	180	110	45	180	
27180314	Urban pool 6.00x2.50, GR, Ht:1.33, filtration	Wooden elements	250	110	120	1,160	1,400
		Plant housing	180	110	45	180	
		filtration	120	50	90	60	
27180414	Urban pool 6.00x2.50, GR, Ht:1.33, heating	Wooden elements	250	110	120	1,160	1,460
		Plant housing	180	110	45	180	
		filtration	120	50	90	60	
		Heat pump	120	80	70	60	
27184218	Urban pool 6.50x3.50, GR, Ht:1.33, auto couv	Pack bois et margelle	170	110	95	585	1,610
		Pack bois	180	110	58	430	
		Pack accessoires	120	100	105	240	
		Pack acier	150	150	35	155	
		Couverture automatique	350	110	40	200	
POOL'N BOX POOL							
27180018	Pool'n Box wooden pool, 6.2x2.5, GR ,Ht: 133	Pack bois et margelle	244	105	107	940	1,125
		Pack accessoires	120	550	88	100	
		Pack acier	150	150	30	85	
TROPIC POOLS							
27102205	Tropic Hexa 410 wooden pool, pine, DB, Ht:120	Wooden elements	215	110	69	510	584
		Accessories	120	50	88	74	
27111205	Tropic 414 wooden pool, pine, DB, Ht:120	Wooden elements	183	110	75	570	644
		Accessories	120	50	88	74	
27112205	Tropic 505 wooden pool, pine, DB, Ht:120	Wooden elements	215	110	75	700	781
		Accessories	120	50	88	81	
27114205	Tropic +450 wooden pool, pine, DB, Ht:120	Wooden elements	303	110	54	655	733
		Accessories	120	50	88	78	
27113206	Tropic +510 wooden pool, pine, DB-75, Ht:120	Wooden elements	360	110	70	790	869
		Accessories	120	50	88	79	
27115205	Tropic +540 wooden pool, pine, DB, Ht:120	Wooden elements	363	110	69	820	902
		Accessories	120	50	88	82	
27116205	Tropic +640 wooden pool, pine, DB, Ht:120	Wooden elements	422	110	69	930	1,020
		Accessories	120	50	88	90	
WEVA POOLS							
27122210	Weva 530 wooden pool, pine, DB, Ht:133	Wooden elements	215	110	83	820	946
		Accessories	120	100	63	126	
27126210	Weva +640 wooden pool, pine, DB, Ht:133	Wooden elements	422	110	69	1,090	1,250
		Accessories	120	100	63	160	
27136210	Weva +640 wooden pool, pine, DB, Ht:146	Wooden elements	422	110	69	1,200	1,363
		Accessories	120	100	63	163	

WOODEN POOL PACKAGING DATA

Code	Model	Pack	Length (cm)	Width (cm)	Height (cm)	Weight (kg)	Total weight (kg)
27128210	Weva +840 wooden pool, pine, DB, Ht:133	Wooden elements	572	110	69	1,420	1,588
		Accessories	120	100	80	168	
27138210	Weva +840 wooden pool, pine, DB, Ht:146	Wooden elements	572	110	69	1,565	1,749
		Accessories	120	100	80	184	
27182211	Weva 3x3 wooden pool, pine, DB, Ht:133	Steel elements	180	113	85	660	885
		Wooden elements	150	150	30	85	
		Accessories	120	100	102	140	
27184210	Weva 6x3 wooden pool, pine, DB, Ht:133	Wooden elements	180	110	74	610	1,384
		Steel elements	180	110	69	430	
		Wooden elements	150	150	35	155	
		Accessories	120	100	102	189	
27196210	Weva 8x4 wooden pool, pine, DB, Ht:146	Steel elements	215	110	83	570	1,986
		Wooden elements	180	110	69	430	
		Wooden elements	180	110	69	505	
		Wooden elements	150	150	45	262	
		Accessories	120	100	122	219	
ODYSSEA POOLS							
27222215 27222515 27322615	Odyssea 530 wooden pool, havana, DB, Ht:133 Odyssea 530 wooden pool, havana, Beige, Ht:133 Odyssea 530 wooden pool, havana, GR, Ht:133	Wooden elements	215	110	74	690	1,078
		Slats	220	50	30	65	
		Coping	203	60	30	116	
		filtration	120	100	75	141	
		Waterproofing	120	100	36	66	
27226215 27226515 27326615	Odyssea +640 wooden pool, havana, DB, Ht:133 Odyssea +640 wooden pool, havana, Beige, Ht:133 Odyssea +640 wooden pool, coastal grey, GR, Ht:133	Wooden elements	422	110	70	970	1,385
		Slats	180	50	30	57	
		Coping	211	60	30	135	
		filtration	120	100	77	141	
		Waterproofing	120	100	48	82	
27236215 27236515 27336615	Odyssea +640 wooden pool, havana, DB, Ht:146 Odyssea +640 wooden pool, havana, Beige, Ht:146 Odyssea +640 wooden pool, coastal grey, GR, Ht:146	Pack lames	422	110	70	1 075	1,493
		Wooden elements	180	50	30	57	
		Coping	211	60	30	135	
		filtration	120	100	77	141	
		Waterproofing	120	100	48	85	
27228215 27228515 27328615	Odyssea +840 wooden pool, havana, DB, Ht:133 Odyssea +840 wooden pool, havana, Beige, Ht:133 Odyssea +840 wooden pool, coastal grey, GR, Ht:133	Wooden elements	576	110	70	1 265	1,731
		Slats	220	50	30	65	
		Coping	205	60	30	166	
		filtration	120	100	77	141	
		Waterproofing	120	100	48	94	
27238215 27238515 27338615	Odyssea +840 wooden pool, havana, DB, Ht:146 Odyssea +840 wooden pool, havana, Beige, Ht:146 Odyssea +840 wooden pool, coastal grey, GR, Ht:146	Wooden elements	576	110	70	1 410	1,880
		Slats	220	50	30	65	
		Coping	205	60	30	166	
		filtration	120	100	77	141	
		Waterproofing	120	100	48	98	
27284215 27284515 27384615	Odyssea 6x3 woodne pool, havana, DB, Ht:133 Odyssea 6x3 woodne pool, havana, Beige, Ht:133 Odyssea 6x3 wooden pool, coastal grey, GR, Ht:133	Steel elements	180	110	70	440	1,485
		Wooden elements	180	110	69	430	
		Slats	180	50	30	80	
		Wooden elements	300	60	30	136	
		Coping	150	150	35	155	
		filtration	120	100	122	170	
27296215 27296515 27396615	Odyssea 8x4 wooden pool, havana, DB, Ht:146 Odyssea 8x4 wooden pool, havana, Beige, Ht:146 Odyssea 8x4 wooden pool, coastal grey, GR, Ht:146	Steel elements	180	110	70	360	2,125
		Slats	180	110	69	430	
		Wooden elements	180	110	69	505	
		Wooden elements	180	50	30	80	
		Wooden elements	200	60	50	211	
		Coping	150	150	45	262	
		filtration	120	100	122	170	
Waterproofing	120	100	48	107			



06

BWT myPOOL Pool kits

P-PSC PARADIS BLEU POOL	126
P-PSC PARADIS BLEU MINI POOL	130
P-PVC PARADIS BLEU POOL	132
PARADIS BLEU COVERS	136



*A hard-wearing,
durable structure*



INFO

A STABLE MATERIAL

» The panels are manufactured in series by injection of synthetic resin, a very strong, rot-proof and unalterable recycled material.

CLEVER DESIGN

- » Reinforcing ribs run the width of panels for even greater strength.
- » Closely spaced supporting braces hold the panels together and ensure the rigidity of the structure.
- » Aluminium hung liner locking track runs across the top of the panels further enhancing the rigidity of the structure.

MADE IN FRANCE

- » Every component of your kit is made in a factory owned by a leading French manufacturer of pool and spa equipment.
- » Non-degressive 10 year guarantee on the panels.

P-PSC POOLS, A PROPER IN-GROUND POOL:

Our P-PSC rectangular pool kits are the perfect solution for customers looking for a simple, affordable pool that is very easy to build.

P-PSC pools are designed to be built in-ground without any great physical or financial effort.

A PROPER IN-GROUND POOL

AN ALL-INCLUSIVE KIT

From the panels themselves to maintenance accessories, everything is included. Pool kits offer a simple solution to allow you build your own, quality pool within your budget.



PANELS AND SUPPORTING BRACES

- » Light, easy to handle and store, the panels constitute the actual structure of your pool. The panels are available in 2 heights: 1.25m and 1.50m and can be used to build pools of any size with any type of floor contour.
- » Panels made entirely of recycled materials to protect our environment.



On the in-ground portion



THE FILTRATION SYSTEM

SOLIFLOW A STAND-ALONE FILTRATION EASY TO INSTALL FOR RELIABLE, EFFICIENT FILTRATION

Soliflow is a filtration block that fits into the deck. It comprises a filter, a pump, 2 return fittings, an underwater light and a remote installed electrical panel to control lighting and filtration times. Delivered pre-assembled, installation is fast and easy.



TECHNICAL DATA:

- » Filtration finesse = 25 µ with the filter bag or 15 µ with the cartridge
- » Filtration surface area, 1.08m² (with filter bag)
- » The return fitting and underwater light may be placed anywhere
- » Fibreglass reinforced acrylic casing
- » Flow rate 11m³/h

INFOS

See details page 13

INFOS

The front panel and the casing of the filtration unit are colour matched to the liner (light blue, grey, beige).



0.75MM LINER

Available in light blue, beige or grey and sold with a polyethylene underlay, they waterproof your pool and provide a perfect finish.



ACCESSORIES

- » A telescopic pole, 1 x 3m
- » A Skim Vac vacuum point
- » Flexible PVC pipe suitable for burying
- » A floating hose, 9m
- » A vacuum head
- » A hand skimmer
- » A Chlorine and pH test kit
- » A thermometer
- » A pot of glue, 125,cc
- » An underwater light LED



SMART DESIGN

4 DIMENSIONS, 2 HEIGHTS AND 3 LINER COLOURS

With its robust structure and meticulous finish, P-PSC pool kits combine the quality and beauty of a traditional pool with all the advantages offered by a kit. The P-PSC range comprises rectangular pools, with flat or curved floors, in a variety of sizes.

DIMENSIONS

- » 6.50 x 3.50m
- » 7.50 x 3.50m
- » 8.50 x 4.50m
- » 9.50 x 4.50m

HEIGHT

- » 1.25 or 1.50m

COLOUR

- » Light blue
- » Beige
- » Grey

INFOS

A Majestic in-pool ladder may be added, listed on page 31

P-PSC RECTANGULAR POOLS 



Code	EAN13	Description	Qty	Unit price	Qty	Unit price	Qty	Unit price
HEIGHT 1.25M								
30903102	3566837151645	Kit P-PSC 6.50x3.50x1.25, Filtration unit, blue liner	1	4,993.00	2	4,743.35	4	4,493.70
30904102	3566837151652	Kit P-PSC 6.50x3.50x1.25, Filtration unit, beige liner	1	4,993.00	2	4,743.35	4	4,493.70
30905102	3566837151669	Kit P-PSC 6.50x3.50x1.25, Filtration unit, grey liner	1	4,993.00	2	4,743.35	4	4,493.70
HEIGHT 1.50M								
30906102	3566837151676	Kit P-PSC 6.50x3.50x1.50, Filtration unit, blue liner	1	5,320.00	2	5,054.00	4	4,788.00
30907102	3566837151683	Kit P-PSC 6.50x3.50x1.50, Filtration unit, beige liner	1	5,320.00	2	5,054.00	4	4,788.00
30908102	3566837151690	Kit P-PSC 6.50x3.50x1.50, Filtration unit, grey liner	1	5,320.00	2	5,054.00	4	4,788.00

Code	EAN13	Description	Qty	Unit price	Qty	Unit price	Qty	Unit price
HEIGHT 1.25M								
30903202	3566837151706	Kit P-PSC 7.50x3.50x1.25, Filtration unit, blue liner	1	5,360.00	2	5,092.00	4	4,824.00
30904202	3566837151713	Kit P-PSC 7.50x3.50x1.25, Filtration unit, beige liner	1	5,360.00	2	5,092.00	4	4,824.00
30905202	3566837151720	Kit P-PSC 7.50x3.50x1.25, Filtration unit, grey liner	1	5,360.00	2	5,092.00	4	4,824.00
HEIGHT 1.50M								
30906202	3566837151737	Kit P-PSC 7.50x3.50x1.50, Filtration unit, blue liner	1	5,700.00	2	5,415.00	4	5,130.00
30907202	3566837151744	Kit P-PSC 7.50x3.50x1.50, Filtration unit, beige liner	1	5,700.00	2	5,415.00	4	5,130.00
30908202	3566837151751	Kit P-PSC 7.50x3.50x1.50, Filtration unit, grey liner	1	5,700.00	2	5,415.00	4	5,130.00

Code	EAN13	Description	Qty	Unit price	Qty	Unit price	Qty	Unit price
HEIGHT 1.25M								
30903302	3566837151768	Kit P-PSC 8.50x4.50x1.25, Filtration unit, blue liner	1	6,170.00	2	5,861.50	4	5,553.00
30904302	3566837151775	Kit P-PSC 8.50x4.50x1.25, Filtration unit, beige liner	1	6,170.00	2	5,861.50	4	5,553.00
30905302	3566837151782	Kit P-PSC 8.50x4.50x1.25, Filtration unit, grey liner	1	6,170.00	2	5,861.50	4	5,553.00
HEIGHT 1.50M								
30906302	3566837151799	Kit P-PSC 8.50x4.50x1.50, Filtration unit, blue liner	1	6,570.00	2	6,241.50	4	5,913.00
30907302	3566837151805	Kit P-PSC 8.50x4.50x1.50, Filtration unit, beige liner	1	6,570.00	2	6,241.50	4	5,913.00
30908302	3566837151812	Kit P-PSC 8.50x4.50x1.50, Filtration unit, grey liner	1	6,570.00	2	6,241.50	4	5,913.00

Code	EAN13	Description	Qty	Unit price	Qty	Unit price	Qty	Unit price
HEIGHT 1.25M								
30903402	3566837151829	Kit P-PSC 9.50x4.50x1.25, Filtration unit, bleu liner	1	6,530.00	2	6,203.50	4	5,877.00
30904402	3566837151836	Kit P-PSC 9.50x4.50x1.25, Filtration unit, beige liner	1	6,530.00	2	6,203.50	4	5,877.00
30905402	3566837151843	Kit P-PSC 9.50x4.50x1.25, Filtration unit, grey liner	1	6,530.00	2	6,203.50	4	5,877.00
HEIGHT 1.50M								
30906402	3566837151850	Kit P-PSC 9.50x4.50x1.50, Filtration unit, bleu liner	1	6,960.00	2	6,612.00	4	6,264.00
30907402	3566837151867	Kit P-PSC 9.50x4.50x1.50, Filtration unit, beige liner	1	6,960.00	2	6,612.00	4	6,264.00
30908402	3566837151874	Kit P-PSC 9.50x4.50x1.50, Filtration unit, grey liner	1	6,960.00	2	6,612.00	4	6,264.00

P-PSC PANELS, FREE-STYLE 

Code	EAN13	Description	Qty	Unit price	Qty	Unit price	Qty	Unit price
P-PSC PANELS, FREE-STYLE, HEIGHT 1.00M								
30102000	3566835491071	P-PSC panel uncut, H = 1.00m L = 0.50m	1	42.20	52	40.09	104	37.98
30102600	3566835484721	P-PSC panel uncut, H = 1.00m L = 1.50m	1	81.50	26	77.43	52	73.35
30182000	3566835485360	P-PSC panel corner R15cm, H = 1.00m L = 0.25m	1	43.30	32	41.14	64	38.97
30192000	3566835485407	Supporting brace/ P-PSC panel, H = 1.00m	1	35.80	44	34.01	88	32.22
30112610	3566835484745	P-PSC panel Filtration unit FA, H = 1.00m L = 1.50m	1	89.30	26	84.84	52	80.37
30112640	3566835484783	P-PSC panel SM-Long (C), H = 1.00m L = 1.50m	1	90.20	26	85.69	52	81.18
30112670	3566835484790	P-PSC panel LM-Long (C), H = 1.00m L = 1.50m	1	90.20	26	85.69	52	81.18
30122600	3566835484950	P-PSC panel UW light (C), H = 1.00m L = 1.50m	1	90.20	26	85.69	52	81.18
30122660	3566837137434	P-PSC panel CSU AFJ x 2, H=1.00m L=1.50m	1	103.20	26	98.04	52	92.88
P-PSC PANELS, FREE-STYLE, HEIGHT 1.25M								
30104000	3566835491088	P-PSC panel uncut, H = 1.25m L = 0.50m	1	47.70	52	45.32	104	42.93
30104200	3566835484738	P-PSC panel uncut, H = 1.25m L = 1.00m	1	74.20	26	70.49	52	66.78
30184000	3566835485384	P-PSC panel corner R15cm, H = 1.25m L = 0.25m	1	45.60	32	43.32	64	41.04
30194000	3566835485414	Supporting brace/ P-PSC panel Ht = 1.25m	1	52.50	32	49.88	64	47.25
30114200	3566835484813	P-PSC panel Filtration unit(L), H=1.25m L=1.00m	1	81.00	26	76.95	52	72.90
30114220	3566835484820	P-PSC panel Filtration unit(R), H=1.25m L=1.00m	1	81.00	26	76.95	52	72.90
30114230	3566835484837	P-PSC panel SM-Long(L), H = 1.25m L = 1.00m	1	82.20	26	78.09	52	73.98
30114250	3566835484844	P-PSC panel SM-Long(R), H = 1.25m L = 1.00m	1	82.20	26	78.09	52	73.98
30114260	3566835484851	P-PSC panel LM-Long(L), H = 1.25m L = 1.00m	1	82.20	26	78.09	52	73.98
30114280	3566835484868	P-PSC panel LM-Long(R), H = 1.25m L = 1.00m	1	82.20	26	78.09	52	73.98
30124210	3566835484974	P-PSC panel UW light(C), H = 1.25m L = 1.00m	1	82.20	26	78.09	52	73.98
30124260	3566837137441	P-PSC panel CSU AFJ x 2, H=1.25m L= 1.00m	1	96.10	26	91.30	52	86.49
P-PSC PANELS, FREE-STYLE, HEIGHT 1.50M								
30106000	3566835491095	P-PSC panel uncut, H = 1.50m L = 0.50m	1	51.50	52	48.93	104	46.35
30102600	3566835484721	P-PSC panel uncut, H = 1.50m L = 1.00m	1	81.50	26	77.43	52	73.35
30186000	3566835485391	P-PSC corner panel R15cm, H = 1.50m L = 0.25m	1	50.20	32	47.69	64	45.18
30196000	3566835485421	Supporting brace/ P-PSC panel, Ht = 1.50m	1	55.70	32	52.92	64	50.13
30116200	3566835484875	P-PSC panel Filtration unit(L), H=1.50m L=1.00m	1	89.30	26	84.84	52	80.37
30116220	3566835484882	P-PSC panel Filtration unit(R), H=1.50m L=1.00m	1	89.30	26	84.84	52	80.37
30116230	3566835484899	P-PSC panel SM-Long(L), H = 1.50m L = 1.00m	1	90.20	26	85.69	52	81.18
30116250	3566835484905	P-PSC panel SM-Long(R), H = 1.50m L = 1.00m	1	90.20	26	85.69	52	81.18
30116260	3566835484929	P-PSC panel LM-Long(L), H = 1.50m L = 1.00m	1	90.20	26	85.69	52	81.18
30116280	3566835484943	P-PSC panel LM-Long(R), H = 1.50m L = 1.00m	1	90.20	26	85.69	52	81.18
30126210	3566835485001	P-PSC panel UW light(C), H = 1.50m L = 1.00m	1	90.20	26	85.69	52	81.18
30126460	3566837137458	P-PSC panel CSU AFJ x 2, H=1.50m L= 1.00m	1	103.20	26	98.04	52	92.88

ACCESSORIES



* To create holes in the panels to seat return fittings and vacuum points at the exact position desired.

Code	EAN13	Description	Qty	Unit price	Qty	Unit price	Qty	Unit price
30309010	3566837135560	Hole saw Ø 60 with adaptor*	1	22.00	6	20.90	12	19.80
3350600	3566837055981	Hung Alu, 1m, for P-PSC structures	1	9.10	40	8.65	80	8.19
30309019	3566837175016	Hung Alu corner piece, P-PSC structure	Page 71					

DELIVERY

Code	Description	Net price exVAT.
30102091	Delivery of the P-PVC structure by appointment	POA
Transport costs are quoted net of any discount.		



Non-contractual photo © Cesar Joana



Non-contractual photo © Piscines et Aménagements

Code	EAN13	Description	Qty	Unit price	Qty	Unit price	Qty	Unit price
P-PSC MINI-POOL KIT WITH SOLIFLOW FILTRATION UNIT								
30905404	3566837221034	Paradis Bleu P-PSC mini-pool/FU 5x2 ht:125 GR	1	3,711.00	2	3,525.45	4	3,339.90
30905204	3566837221041	Paradis Bleu P-PSC mini-pool/FU 4x2,5 ht:125 GR	1	3,901.00	2	3,705.95	4	3,510.90
30905004	3566837221058	Paradis Bleu P-PSC mini-pool/FU 3x3 ht:125 GR	1	3,795.00	2	3,605.25	4	3,415.50
30908404	3566837221065	Paradis Bleu P-PSC mini-pool/FU 5x2 ht:150 GR	1	3,997.00	2	3,797.15	4	3,597.30
30908204	3566837221072	Paradis Bleu P-PSC mini-pool/FU 4x2,5 ht:150 GR	1	3,997.00	2	3,797.15	4	3,597.30
30908004	3566837221089	Paradis Bleu P-PSC mini-pool /FU 3x3 ht:150 GR	1	4,214.00	2	4,003.30	4	3,792.60
P-PSC MINI-POOL KIT WITH SAND FILTER								
30905003	3566837221119	Paradis Bleu P-PSC mini-pool/SF 3x3 ht:125 GR	1	3,425.00	2	3,253.75	4	3,082.50
30908003	3566837221140	Paradis Bleu P-PSC mini-pool/SF 3x3 ht:150 GR	1	3,845.00	2	3,652.75	4	3,460.50
30905203	3566837221102	Paradis Bleu P-PSC mini-pool /SF 4x2,5 ht:125 GR	1	3,532.00	2	3,355.40	4	3,178.80
30908203	3566837221133	Paradis Bleu P-PSC mini-pool/SF 4x2,5 ht:150 GR	1	3,628.00	2	3,446.60	4	3,265.20
30905403	3566837221096	Paradis Bleu P-PSC mini-pool/SF 5x2 ht:125 GR	1	3,341.00	2	3,173.95	4	3,006.90
30908403	3566837221126	Paradis Bleu P-PSC mini-pool/SF 5x2 ht:150 GR	1	3,627.00	2	3,445.65	4	3,264.30

DELIVERY

Code	Description	Qty	Unit price
30102091	Delivery of a Paradis Bleu by appointment	1	POA

Transport costs are quoted net of any discount.



On the in-ground portion

YOUR DREAM POOL WITHOUT THE FUSS



A proper in-ground pool without the fuss? You're not dreaming, it's the Paradis Bleu P-PSC mini-pool. With its small 10m² footprint, it can be easily integrated into any space. The Paradis Bleu mini-pool kit contains everything you need to build your pool and fit it out.

Paradis Bleu mini-pool gives maximum joy for a minimum cost, both to buy and to maintain. So, don't delay, make your dreams come true!



PANELS AND SUPPORTING BRACES

The structure is made of injected resin panels. Rot-proof and chemically inert, they have been tried and tested for over twenty years by the leading French manufacturer of pool equipment.

- » Easy to assemble, requiring very little physical effort. Light, easy to handle and store, the panels constitute the actual structure of your pool.
- » The panels are available in 2 heights: 1.25m and 1.50m and can be used to build pools of any size with any type of floor contour.
- » Panels made entirely of recycled materials to protect our environment.



SAND FILTER OR SOLIFLOW

You may choose either a conventional sand filter or a Soliflow unit, very easy and quick to install:

SOLIFLOW AUTONOMOUS FILTRATION UNIT

Easy to install for reliable, efficient filtration.

- » The Soliflow unit is filtration block that is fitted into the deck. It comprises a filter, a pump, 2 return fittings, an underwater light and a remote installed electrical panel to control lighting and filtration times. Delivered pre-assembled, installation is fast and easy.

See details page 13



The front panel and the casing of the filtration unit is grey to match the colour of the liner.

P-GFI 400, 4M³/H, GREY FILTRATION GROUP

- » Light grey ABS injected sand filter. Self-priming pump with pre-filter.
- » Delivered with 25kg of sand.

See details page 16



0.75MM LINER

The liner is grey and is delivered with a polyethylene underlay, to waterproof your pool and provide a perfect finish.



ACCESSORIES

- » Hole saw Ø60 with adaptor,
- » PVC pressure glue, 250ml,
- » PVC stripper, 500ml,
- » Panel UW light LED,
- » All the necessary pipework (Flexible and rigid pipes, 1/4 turn valves, elbows, threaded nipples),
- » A main drain,
- » A filtration electrical panel P-315 in kits that include a sand filter.



A TOUCH OF ELEGANCE

Entirely in-ground and beautifully finished, the Paradis Bleu mini-pool brings a touch of elegance to your garden, enhancing any setting.

MAX SECURITY OPTION

- » The Paradis Bleu mini-pool can be fitted with safety covers to secure access to the pool: automatic slat cover or bar cover.

DIMENSIONS

- » 3 × 3m
- » 4 × 2,5m
- » 5 × 2m

HEIGHT

- » 1.25m
- » 1.50m

COLOUR

- » Grey

P-PVC CONCEPT

UPPER REINFORCING
STEEL BELT
(NOT SUPPLIED)

NO BOLTS: THE INTERLOCKING
PANELS FIT TOGETHER RAPIDLY
(DOVE-TAILED)

VERY HARD-WEARING,
INSULATING, HONEYCOMB
PANEL

LINER LOCKING SYSTEM
(FACILITATES FITTING AND
REMOVAL OF THE LINER)

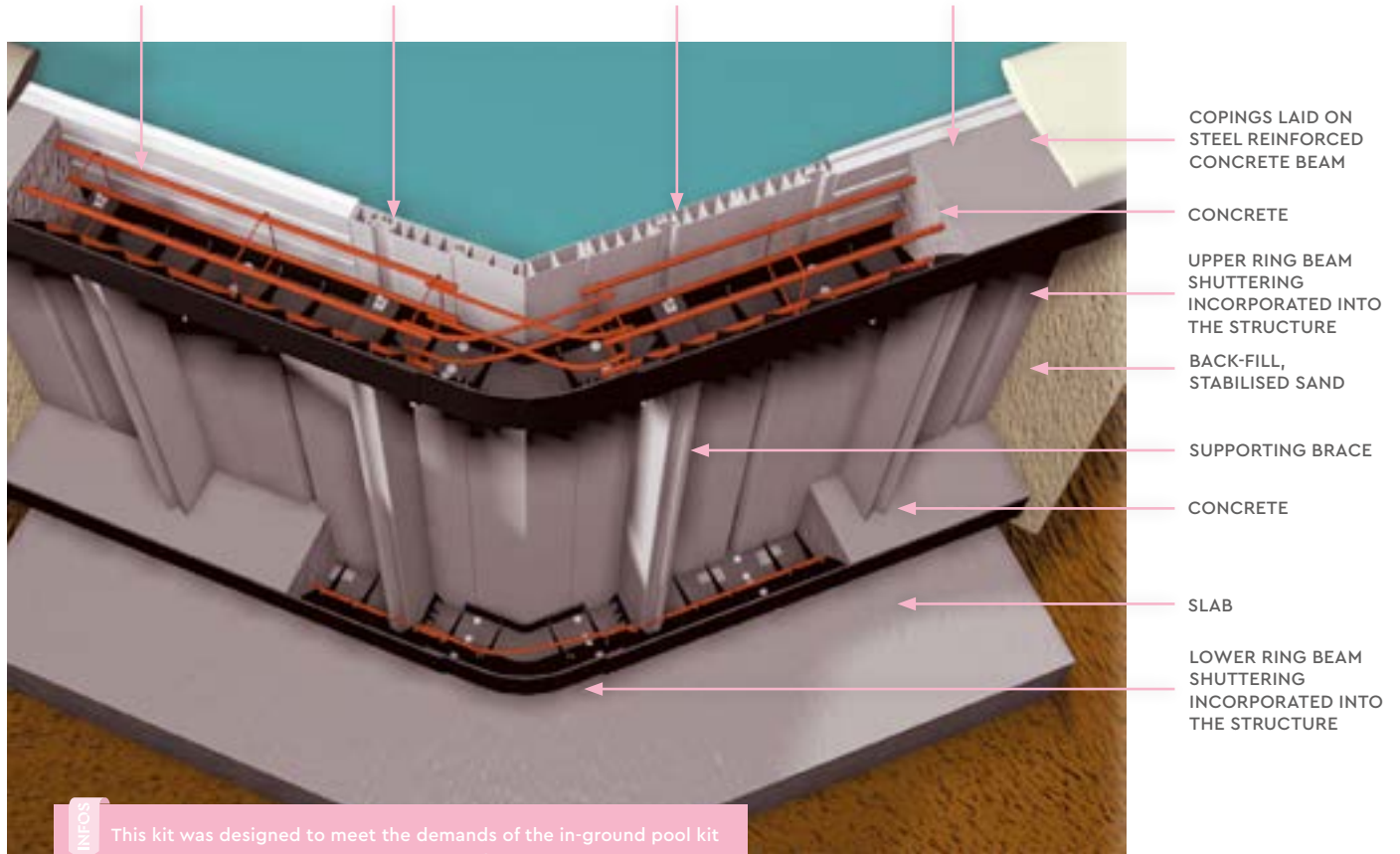

INFO

This kit was designed to meet the demands of the in-ground pool kit market. Its revolutionary design does not feature any screws, nuts or bolts. Child's play to build, it does not contain any components that could rust.

The structure is guaranteed 10 years.

With the P-PVC concept we can offer fully fitted out pools rectangular and octagonal pools, even non-standard pools can be created from our range of free style elements. A range of filtration options and multitude of options round out the P-PVC offer.

POSSIBLE SHAPES

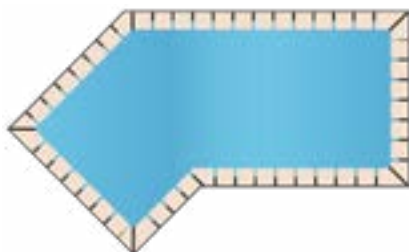

LAZY

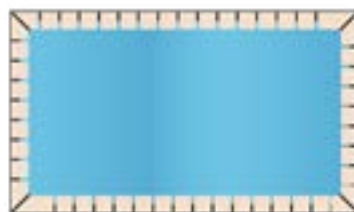

RECTANGULAR

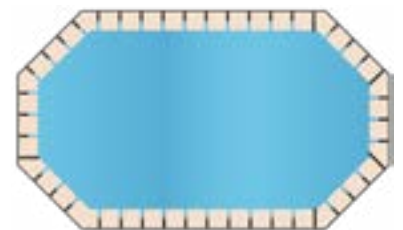

OCTAGONAL

A PROPER IN-GROUND POOL

AN ALL-INCLUSIVE KIT

From the panels themselves to maintenance accessories, everything is included. Pool kits offer a simple solution to allow you build your own, quality pool within your budget.



PANELS & SHUTTERING

» Light, easy to handle and store, the panels constitute the actual structure of your pool. The panels are available in 2 heights: 1.25m and 1.55m and can be used to build pools of any size with any type of floor contour.

» PVC extruded panels made entirely of recycled materials to protect our environment.



On the in-ground portion



THE FILTRATION SYSTEM

P-FI FILTRATION GROUP

Easy to install for reliable, efficient filtration.

The colour of the pool fittings matches the colour of the liner.

- | | |
|-------------------------------|---------------------------------------|
| 2 Skimmers P-SM long* | 1 Deck box |
| 2 Return fittings* with jets* | 1 P-AP pump, 6 or 11m ³ /h |
| 1 Underwater light* LED | 1 P-FI 400 or 500 filter |



INFOS

* Colour matched to the liner.



0.75MM LINER

Available in light blue, beige or grey and sold with a polyethylene underlay, they waterproof your pool and provide a perfect finish.



ACCESSORIES

- | | |
|--|---------------------------------------|
| » A telescopic pole, 1 x 3m | » A Chlorine and pH test kit |
| » A Skim Vac vacuum point | » A thermometer |
| » Flexible PVC pipe suitable for burying | » A pot of glue, 125,cc |
| » A floating hose, 9m | » 1 Filtration electrical panel P-050 |
| » A vacuum head | » 1 Hole saw |
| » A hand skimmer | |



SMART DESIGN

4 DIMENSIONS, 2 HEIGHTS AND 3 LINER COLOURS

With its robust structure and meticulous finish, P-PVC Paradis Bleu pool kits combine the quality and beauty of a traditional pool with all the advantages offered by a kit. The P-PVC Paradis Bleu range comprises rectangular pools, with flat or curved floors, in a variety of sizes.

DIMENSIONS

- » 6.50 x 3.50m
- » 7.50 x 3.50m
- » 8.50 x 4.50m
- » 9.50 x 4.50m

HEIGHT

- » 1.25 or 1.55m

COLOUR

- » Light blue
- » Beige
- » Grey

P-PVC RECTANGULAR POOLS 

Code	EAN13	Description	Qty	Unit price	Qty	Unit price	Qty	Unit price
KIT P-PVC 6.50X3.50								
5521419	3566837160319	Kit P-PVC 6.50x3.50x1.25, skimmer / P-FI 400, blue liner	1	4,513.00	2	4,287.35	4	4,061.70
5522419	3566837160234	Kit P-PVC 6.50x3.50x1.25, skimmer / P-FI 400, beige liner	1	4,513.00	2	4,287.35	4	4,061.70
5523419	3566837160159	Kit P-PVC 6.50x3.50x1.25, skimmer / P-FI 400, grey liner	1	4,513.00	2	4,287.35	4	4,061.70
5521619	3566837160272	Kit P-PVC 6.50x3.50x1.55, skimmer / P-FI 400, blue liner	1	4,917.00	2	4,671.15	4	4,425.30
5522619	3566837160197	Kit P-PVC 6.50x3.50x1.55, skimmer / P-FI 400, beige liner	1	4,917.00	2	4,671.15	4	4,425.30
5523619	3566837160111	Kit P-PVC 6.50x3.50x1.55, skimmer / P-FI 400, grey liner	1	4,917.00	2	4,671.15	4	4,425.30
KIT P-PVC 7.50X3.50								
5521429	3566837160302	Kit P-PVC 7.50x3.50x1.25, skimmer / P-FI 400, blue liner	1	4,807.00	2	4,566.65	4	4,326.30
5522429	3566837160227	Kit P-PVC 7.50x3.50x1.25, skimmer / P-FI 400, beige liner	1	4,807.00	2	4,566.65	4	4,326.30
5523429	3566837160142	Kit P-PVC 7.50x3.50x1.25, skimmer / P-FI 400, grey liner	1	4,807.00	2	4,566.65	4	4,326.30
5521629	3566837160265	Kit P-PVC 7.50x3.50x1.55, skimmer / P-FI 400, blue liner	1	5,370.00	2	5,101.50	4	4,833.00
5522629	3566837160180	Kit P-PVC 7.50x3.50x1.55, skimmer / P-FI 400, beige liner	1	5,370.00	2	5,101.50	4	4,833.00
5523629	3566837160104	Kit P-PVC 7.50x3.50x1.55, skimmer / P-FI 400, grey liner	1	5,370.00	2	5,101.50	4	4,833.00
KIT P-PVC 8.50X4.50								
5521439	3566837160296	Kit P-PVC 8.50x4.50x1.25, skimmer / P-FI 500, blue liner	1	5,550.00	2	5,272.50	4	4,995.00
5522439	3566837160210	Kit P-PVC 8.50x4.50x1.25, skimmer / P-FI 500, beige liner	1	5,550.00	2	5,272.50	4	4,995.00
5523439	3566837160135	Kit P-PVC 8.50x4.50x1.25, skimmer / P-FI 500, grey liner	1	5,550.00	2	5,272.50	4	4,995.00
5521639	3566837160258	Kit P-PVC 8.50x4.50x1.55, skimmer / P-FI 500, blue liner	1	6,090.00	2	5,785.50	4	5,481.00
5522639	3566837160173	Kit P-PVC 8.50x4.50x1.55, skimmer / P-FI 500, beige liner	1	6,090.00	2	5,785.50	4	5,481.00
5523639	3566837160098	Kit P-PVC 8.50x4.50x1.55, skimmer / P-FI 500, grey liner	1	6,090.00	2	5,785.50	4	5,481.00
KIT P-PVC 9.50X4.50								
5521449	3566837160289	Kit P-PVC 9.50x4.50x1.25, skimmer / P-FI 500, blue liner	1	5,870.00	2	5,576.50	4	5,283.00
5522449	3566837160203	Kit P-PVC 9.50x4.50x1.25, skimmer / P-FI 500, beige liner	1	5,870.00	2	5,576.50	4	5,283.00
5523449	3566837160128	Kit P-PVC 9.50x4.50x1.25, skimmer / P-FI 500, grey liner	1	5,870.00	2	5,576.50	4	5,283.00
5521649	3566837160241	Kit P-PVC 9.50x4.50x1.55, skimmer / P-FI 500, blue liner	1	6,460.00	2	6,137.00	4	5,814.00
5522649	3566837160166	Kit P-PVC 9.50x4.50x1.55, skimmer / P-FI 500, beige liner	1	6,460.00	2	6,137.00	4	5,814.00
5523649	3566837160081	Kit P-PVC 9.50x4.50x1.55, skimmer / P-FI 500, grey liner	1	6,460.00	2	6,137.00	4	5,814.00

DELIVERY

Code	EAN13	Description	Qty	Unit price
30102091	3566837121655	Delivery of the P-PVC structure by appointment	1	POA

Transport costs are quoted net of any discount.

SAMPLE CALCULATION, STRUCTURES PER M (MARGIN OF ERROR +/- 3%):

POOL HEIGHT 1.06M 1 90° CORNER =	POOL HEIGHT 1.06M 1M =	POOL HEIGHT 1.06M » 1 135° CORNER, 30 ON EACH SIDE =
<ul style="list-style-type: none"> » 1 90° corner panel » 2 top corner shutterings » 2 bottom corner shutterings » 1 corner fastener » 8 clips 	<ul style="list-style-type: none"> » four 0.25m panels » 2 supporting braces » 1m fastener » 2 top shutterings » 2 bottom shutterings » 16 clips » 2 tie-bar supports, small model 	<ul style="list-style-type: none"> » 1 135° corner panel » 2 top corner shuttering » 1 bottom corner shuttering » 2 0.25m panels » 2 supporting braces » 2 top shutterings » 2 bottom shutterings » 16 clips » 2 tie-bar supports, small model » 60cm of fasteners

SUPPORTING BRACES & P-PVC PANELS 

Code	EAN13	Description	Qty	Unit price	Qty	Unit price	Qty	Unit price
SUPPORTING BRACE/ P-PVC PANEL								
5663200	3566831115292	Supporting brace / P-PVC panel, 1.10	48	5.85	96	5.53	192	5.20
5663400	3566831115308	Supporting brace / P-PVC panel, 1.25	48	6.75	96	6.38	192	6.00
5663600	3566831115315	Supporting brace / P-PVC panel, 1.55	48	8.28	96	7.82	192	7.36
P-PVC PANELS, UNCUT								
5662200	3566831115261	P-PVC panel uncut, H = 1.10m L = 0.125	48	6.75	96	6.38	102	6.00
5662400	3566831115278	P-PVC panel uncut, H = 1.25m L = 0.125	48	7.56	96	7.14	192	6.72
5662600	3566831115285	P-PVC panel uncut, H = 1.55m L = 0.125	48	9.27	96	8.76	192	8.24
5661200	3566831115230	P-PVC panel uncut, H = 1.10m L = 0.25	26	13.23	52	12.50	102	11.76
5661400	3566831115247	P-PVC panel uncut, H = 1.25m L = 0.25	26	14.94	52	14.11	102	13.28
5661600	3566831115254	P-PVC panel uncut, H = 1.55m L = 0.25	26	18.36	52	17.34	102	16.32
P-PVC PANEL - SKIMMER SM-LONG								
5620210	3566837064082	P-PVC panel SM-Long, H = 1.10m L = 0.25m	1	45.00	8	42.75	16	40.50
5620410	3566837064242	P-PVC panel SM-Long, H = 1.25m L = 0.25m	1	47.60	8	45.22	16	42.84
5620610	3566837064297	P-PVC panel SM-Long, H = 1.55m L = 0.25m	1	52.20	8	49.59	16	46.98
P-PVC PANEL - UNDERWATER LIGHT								
5625210	3566837063955	P-PVC panel UW light(C), H = 1.10m L = 0.50m	1	49.10	8	46.65	16	44.19
5625410	3566837063979	P-PVC panel UW light(C), H = 1.25m L = 0.50m	1	53.50	8	50.83	16	48.15
5625610	3566837062613	P-PVC panel UW light(C), H = 1.55m L = 0.50m	1	61.40	8	58.33	16	55.26
90° ANGLE								
5665200	3566831115353	90° angle, 10 cm cut / Panel P-PVC, H = 1.10 m	4	31.68	16	24.82	48	23.36
5665400	3566831115360	90° angle, 10 cm cut / Panel P-PVC, H = 1.25 m	4	29.92	16	20.40	48	19.20
5665600	3566831115377	90° angle, 10 cm cut / Panel P-PVC, H = 1.50 m	4	28.16	16	34.94	48	32.88
135° ANGLE FOR OCTAGONAL POOLS								
5664200	3566831115322	135° angle/ P-PVC panel, H = 1.10 m	4	7.56	16	7.14	48	6.72
5664400	3566831115339	135° angle/ P-PVC panel, H = 1.25 m	4	8.55	16	8.08	48	7.60
5664600	3566831115346	135° angle/ P-PVC panel, H = 1.50 m	4	10.62	16	10.03	48	9.44

POOL STRUCTURE ELEMENTS 

Code	EAN13	Description	Qty	Unit price	Qty	Unit price	Qty	Unit price
5667200	3566831115414	90° corner/ P-PVC panel, H = 1.10m L = 0.04m	4	2.84	16	2.68	48	2.52
5666200	3566831115384	Extension / P-PVC panel, H = 1.10m L = 0.02m	4	11.07	16	10.46	48	9.84
5667400	3566831115421	90° corner/ P-PVC panel, H = 1.25m L = 0.04m	4	3.36	16	3.17	48	2.98
5666400	3566831115391	Extension / P-PVC panel, H = 1.25m L = 0.02m	4	12.42	16	11.73	48	11.04
5667600	3566831115438	90° corner/ P-PVC panel, H = 1.55m L = 0.04m	4	3.98	16	3.76	48	3.54
5664600	3566831115346	135° corner/ P-PVC panel, H = 1.55m	8	3.83	16	3.62	32	3.41
5666600	3566831115407	Extension / P-PVC panel, H = 1.55m L = 0.02m	4	15.12	16	14.28	48	13.44
5645000	3566831115179	P-PVC coffering clips, bag of 100	4	7.38	8	6.97	24	6.56
5646000	3566831115186	P-PVC corner shuttering, top and bottom	8	3.83	16	3.62	32	3.41
5642000	3566831115148	P-PVC bottom shuttering, 500mm	27	6.93	54	6.55	108	6.16
5641000	3566831115131	P-PVC top shuttering, 500mm	27	6.75	54	6.38	108	6.00
5641001	3566837043575	P-PVC shuttering, corner outlet top left	4	14.22	8	13.43	24	12.64
5641002	3566837043506	P-PVC shuttering, corner outlet top right	4	14.22	8	13.43	24	12.64
5642001	3566837043537	P-PVC shuttering, corner outlet bottom left	4	14.22	8	13.43	24	12.64
5642002	3566837043544	P-PVC shuttering, corner outlet bottom right	4	14.22	8	13.43	24	12.64
5649000	3566835397717	Rebar d 6mm length 23cm	50	0.41	125	0.39	500	0.37
5643000	3566831115155	P-PVC rebar support, small model	50	0.56	125	0.53	500	0.50
5648000	3566831115223	P-PVC Hung linerlock, corner, per unit	4	3.54	8	3.34	24	3.14
5647000	3566831115193	Hung P-PVC strip, 2m length, per ml	20	15.75	40	14.88	80	14.00
30309010	3566837135560	Hole saw Ø 60 with adaptor *	1	22.00	6	20.90	12	19.80



* To create holes in the panels to seat return fittings and vaccum points at the exact position desired.



P-280 BUBBLE COVERS FOR PARADIS BLEU POOLS

Code	EAN13	Description	Qty	Unit price	Qty	Unit price	Qty	Unit price
2061009	3566837155070	Bubble cover P-280, Paradis bleu, 6.5 × 3.5	1	101.10	4	96.05	12	90.99
2061109	3566837155087	Bubble cover P-280, Paradis bleu, 7.5 × 3.5	1	113.10	4	107.45	12	101.79
2061209	3566837155094	Bubble cover P-280, Paradis bleu, 8.5 × 4.5	1	163.00	4	154.85	12	146.70
2061309	3566837155100	Bubble cover P-280, Paradis bleu, 9.5 × 4.5	1	176.50	4	167.68	12	158.85

TECHNICAL DATA:

- » Ultrasonically welded, lengthwise,
- » Strip width is 2metres, strips 1m wide may be welded on to create 'odd' widths,
- » The roll may feature one or two transversal weld seams.

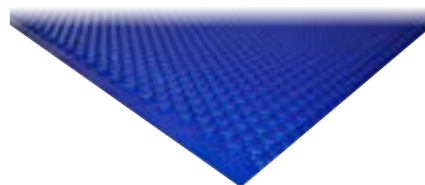

Unfinished, no hem or eyelets

GREY

P-580 BAR COVERS FOR PARADIS BLEU POOLS

Code	EAN13	Description	Qty	Unit price	Qty	Unit price	Qty	Unit price
6304161	3566837155117	P-580 bar cover, Paradis bleu, 6.5 × 3.5	1	825.00	4	783.75	12	742.50
6304261	3566837155124	P-580 bar cover, Paradis bleu, 7.5 × 3.5	1	924.00	4	877.80	12	831.60
6304361	3566837155131	P-580 bar cover, Paradis bleu, 8.5 × 4.5	1	1,106.00	4	1,050.70	12	995.40
6304461	3566837155148	P-580 bar cover, Paradis bleu, 9.5 × 4.5	1	1,202.00	4	1,141.90	12	1,081.80



TECHNICAL DATA:

- » The P-580 bar cover is made of very hard wearing PVC coated polyester (580g/m²), treated to withstand U.V.
- » The material is unbroken where it passes under the bars to provide increased mechanical strength. Both sides of the cover are varnished to protect it from damage from chemical products, wear and abrasion.
- » Anodised aluminium bars strengthen and reinforce the cover, allowing it to bear the weight of a child falling onto it without sustaining any damage.

GREY

P-W 580 SAFETY COVERS FOR PARADIS BLEU POOLS

Code	EAN13	Description	Qty	Unit price	Qty	Unit price	Qty	Unit price
8338109	3566837159672	P-W 580 bar cover, Paradis bleu, 6.5 × 3.5	1	475.00	4	451.25	12	427.50
8338209	3566837159665	P-W 580 bar cover, Paradis bleu, 7.5 × 3.5	1	530.00	4	503.50	12	477.00
8338309	3566837159658	P-W 580 bar cover, Paradis bleu, 8.5 × 4.5	1	703.00	4	667.85	12	632.70
8338409	3566837159641	P-W 580 bar cover, Paradis bleu, 9.5 × 4.5	1	769.00	4	730.55	12	692.10



TECHNICAL DATA:

- » The P-W 580 cover is made of opaque, PVC coated 580g reinforced woven polyester,
- » The surface in contact with the ground is beige coloured, to avoid the risk of staining,
- » Cleverly spaced perforations allow rain water to drain rapidly, preventing the formation of water pockets,
- » On pools that features steps and free form pools, additional perforations are made,
- » The PVC coating on the P-W 580 cover is treated to block UV, it is also resistant to chlorine,
- » The P-W 580 cover is edged with a peripheral strip and individual straps to fasten it to the deck,
- » Colour: grey/ beige.



P-HS E AUTOMATIC COVERS FOR PISCINES PARADIS BLEU

Code	EAN13	Description	Qty	Unit price	Qty	Unit price	Qty	Unit price
34880309	3566837155155	P-HS E automatic cover, Paradis bleu, 6,5 × 3,5	1	2,853.00	4	2,710.35	12	2,567.70
34881309	3566837155162	P-HS E automatic cover, Paradis bleu, 7,5 × 3,5	1	2,985.00	4	2,835.75	12	2,686.50
34882309	3566837155179	P-HS E automatic cover, Paradis bleu, 8,5 × 4,5	1	3,433.00	4	3,261.35	12	3,089.70
34883309	3566837155186	P-HS E automatic cover, Paradis bleu, 9,5 × 4,5	1	3,564.00	4	3,385.80	12	3,207.60

INFOS Installation of a P-HS E automatic cover implies removal of the ladder each time the cover is deployed.
 On pools fitted with a peripheral deck at the same height as the coping, installation of a hinged hand rail (60223009) will avoid the need to remove the ladder.

TRANSPORT COSTS FOR AUTOMATIC AND BAR COVERS

Code	Description	Qty	Unit price
32900100	P-HS E automatic cover transport costs < 4.10m, delivery to the installer, no appointment, no forklift	1	POA
32900300	P-HS E automatic cover transport costs < 5.10m, delivery to the installer, no appointment, no forklift	1	POA
32902100	P-HS E automatic cover transport costs < 4.10m, delivery to the installation site	1	POA
32902300	P-HS E automatic cover transport costs < 5.10m, delivery to the installation site	1	POA
6490100	Bar cover transports costs, delivery by appointment	1	POA

Transport costs are quoted net of any discount.



SAFETY ASSURED

The P-HS E automatic cover is the best means of preventing accidental falls into your pool. This cover complies with the French safety standard NF P90-308 and allows you to enjoy your pool with complete peace of mind.





07

BWT myPOOL Spa

SP-ANTARES-2.18 SB	140
SP-ANTARES-5.23 SB	142
SP-2.18 SB	144
SP-3.17 SB	146
SP-4.31 SB	148
SP-5.32 SB	150
SP-7.36 SB	152
SPA ACCESSORIES	154
PACKING INFORMATION	155

PORTABLE VERSION
2 MASSAGE STATIONS
2 LOUNGERS
18 MASSAGE JETS



JET FINISH,
PVC



COMPOSITE GREY
SURROUND



MARBLED WHITE



AIR CONTROLS

LOUNGER 1

Back: 1 rotating jet, 110mm
2 mini-jets
Lower back: 6 mini-jets

LOUNGER 2

Back: 1 dual rotating jet, 95mm
2 mini-jets
Lower back: 6 mini-jets

DIGITAL CONTROL PAD

LED UW LIGHT



AIR CONTROLS

ACCESSORIES INCLUDED WITH THE SPA:



Non-contractual photo

WEIGHT/ VOLUME/ DIMENSIONS/ FLOW RATES

- » Empty weight: 230Kg / Full weight: 720Kg / Water volume: 490 litres
- » Portable version: 198cm (L) x 139cm (W) x 65cm (H)
- » Removable step: 98cm (L) x 45.5cm(W) x 41cm (H)
- » Jet and spa pack flow rate: 26 m³/h

EQUIPMENT

- » 1 Colour LED underwater light
- » 1 Skimmer (1 cartridge, 3.2m²)
- » 2 Head rests
- » 1 Rigid cover
- » 1 Main drain
- » 1 Spa pack 1 electrical panel with 1 electric heater (2 kW), 1 Two-speed pump
- » 1 Step

2 MASSAGE STATIONS, 18 MASSAGE JETS

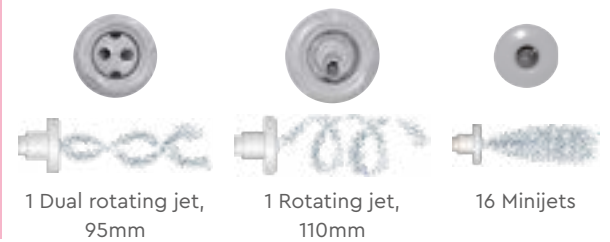

SPA

Code	EAN13	Description	Qty	Unit price	Qty	Unit price	Qty	Unit price
31840805	3566837153748	Spa SP-Antares-2.18, marbled white, grey composite	1	5,790.00	2	5,500.50	4	5,211.00

SPA COMMISSIONING

Code	EAN13	Description	Unit price
92346	3566835527619	Commissioning a spa	POA

SPA DELIVERY

Code	EAN13	Description	Unit price
31090400	3566835483854	Delivery/ pick-up of a spa	POA

Transport costs are quoted net of any discount.

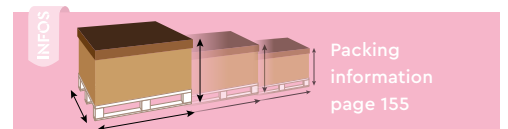

- PORTABLE VERSION
- 5 MASSAGE STATIONS
- 1 LOUNGER
- 2 BUCKET SEATS
- 2 SEATS
- 23 MASSAGE JETS



JET FINISH, PVC



COMPOSITE GREY SURROUND



MARBLED WHITE



LOUNGER

Back: 1 dual rotating jet, 95mm
 2 mini-jets
 Lower back: 6 mini-jets

DIVERTING VALVE

SEAT 1

Back: 1 directional jet, 70mm
 Lower back: 1 directional jet
 70mm

SEAT 2

Back: 1 directional jet, 70mm
 Lower back: 1 directional jet, 70mm

BUCKETS SEAT 1

Back: 2 rotating jets, 95mm
 Lower back : 1 rotating jet, 95mm

BUCKET SEAT 2

Shoulders: 2 directional jets, 70mm
 Back: 1 rotating jet, 110mm
 2 directional jets, 70mm
 Lower back : 2 directional jets, 70mm

AIR CONTROLS

LED UW LIGHT

DIGITAL CONTROL PAD



ACCESSORIES INCLUDED WITH THE SPA:



WEIGHT/ VOLUME/ DIMENSIONS/ FLOW RATES

- » Empty weight: 300Kg / Full weight: 1,300Kg / Water volume: 1,000 litres
- » Portable version: 199cm (L) x 199cm (W) x 78cm (H)
- » Removable step: 98cm (L) x 45.5cm (W) x 41cm (H)
- » Jet and spa pack flow rate: 26m³/h

EQUIPMENT

- » 1 Colour LED underwater light
- » 1 Skimmer (1 cartridge, 3.2m²)
- » 3 Head rests
- » 1 Rigid cover
- » 1 Main drain
- » 1 Spa pack:
 - 1 electrical panel with 1 electric heater (2 kW)
 - 1 Two speed pump
- » 1 Step

5 MASSAGE STATIONS, 23 MASSAGE JETS

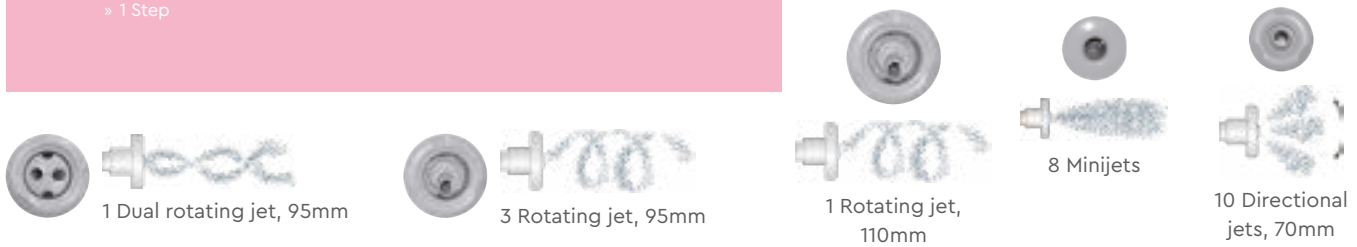

SPA

Code	EAN13	Description	Qty	Unit price	Qty	Unit price	Qty	Unit price
31940805	3566837153755	Spa SP-Antares-5.23, marbled white, composite grey	1	6,570.00	2	6,241.50	4	5,913.00

SPA COMMISSIONING

Code	EAN13	Description	Unit price
92346	3566835527619	Commissioning a spa	POA

SPA DELIVERY

Code	EAN13	Description	Unit price
31090420	3566835483854	Delivery/ pick-up of a spa	POA

Transport costs are quoted net of any discount.

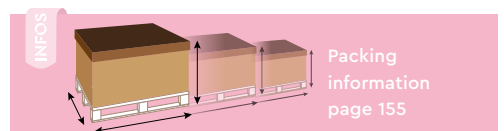

PORTABLE VERSION
2 MASSAGE STATIONS
2 LOUNGERS FACING EACH OTHER
18 MASSAGE JETS



JET FINISH, PVC



COMPOSITE GREY SURROUND



MARBLED WHITE



LOUNGER

Neck: 2 directional jets, 70mm
 Shoulders: 3 rotating jets, 95mm
 Back: 2 directional jets, 95mm
 Lower back : 2 directional jets, 70mm

AIR CONTROLS

SKIMMER
 (1 cartridge)



LED UNDERWATER LIGHT

DIGITAL CONTROL PAD

AIR CONTROLS

LOUNGER

Neck: 2 directional jets, 70mm
 Shoulders: 3 directional jets, 95mm
 Back: 2 directional jets, 95mm
 Lower back : 2 directional jets, 70mm

DIVERTING VALVE

ACCESSORIES INCLUDED WITH THE SPA:



Access steps



Rigid cover (delivered with two locking clips)



WEIGHT/ VOLUME/ DIMENSIONS/ FLOW RATES

- » Empty weight: 230Kg / Full weight: 720Kg / Water volume: 490 litres
- » Portable version: 198cm (L) x 141cm (W) x 66cm (H)
- » Removable step: 98cm (L) x 45.5cm (W) x 41cm (H)
- » Jet and spa pack flow rate: 26m³/h

EQUIPMENT

- » 1 Colour LED UW light
- » 1 Skimmer (1 cartridge, 3.2m²)
- » 2 Head rests
- » 1 Rigid cover
- » 1 Main drain
- » 1 Spa pack:
 - 1 electrical panel with 1 electric heater (2 kW)
 - 1 Two speed pump
- » 1 Step

2 MASSAGE STATIONS, 18 MASSAGE JETS



SPA

Code	EAN13	Description	Qty	Unit price	Qty	Unit price	Qty	Unit price
31540805	3566837153762	Spa SP-2.18 SB, marbled white, grey composite	1	6,540.00	2	6,213.00	4	5,886.00

SPA COMMISSIONING

Code	EAN13	Description	Unit price
92346	3566835527619	Commissioning a spa	POA

SPA DELIVERY

Code	EAN13	Description	Unit price
31090420	3566835483854	Delivery/ pick-up of a spa	POA

Transport costs are quoted net of any discount.

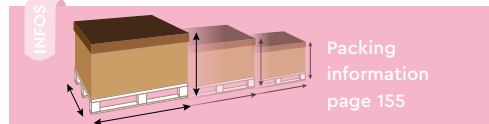

- PORTABLE VERSION
- 3 MASSAGE STATIONS
- 1 LOUNGER
- 2 BUCKET SEATS
- 17 MASSAGE JETS



JET FINISH, PVC



COMPOSITE GREY SURROUND



MARBLED WHITE



DIVERTING VALVE

AIR CONTROLS

LOUNGER

Neck: 2 directional jets, 70mm
 Shoulders: 3 rotating jets, 95mm
 Back: 2 rotating jets, 95mm
 Lower back : 2 directional jets, 70mm

BUCKET SEAT

Shoulders: 2 directional jets, 95mm
 Back: 1 directional jet, 95mm
 Calves: 2 directional jets, 95mm

LED UNDERWATER LIGHT

DIGITAL CONTROL PAD

BUCKET SEAT

Back: 1 directional jet, 95mm
 Lower back: 1 directional jet, 95mm

SKIMMER
 (2 cartridges)

CHILD'S SEAT

Back: 1 directional jet, 70mm



ACCESSORIES INCLUDED WITH THE SPA:



WEIGHT/ VOLUME/ DIMENSIONS/ FLOW RATES

- » Empty weight: 250Kg / Full weight: 1,000kg / Water volume: 750Litres
- » Portable version: 213cm (L) x 168cm (W) x 80cm (H)
- » Removable step: 78,5cm (L) x 57,5cm (W) x 50cm (H)
- » Jet and spa pack flow rate: 26m³/h

EQUIPMENT

- » 1 Colour LED underwater light
- » 1 Skimmer (2 cartridges, 3.2m²)
- » 3 Head rests
- » 1 Rigid cover
- » 2 Main drains
- » 1 Spa pack:
 - 1 electrical panel with 1 electric heater (2 kW), 1 two speed pump
- » 1 Two tread step

3 MASSAGE STATIONS, 17 MASSAGE JETS



SPA

Code	EAN13	Description	Qty	Unit price	Qty	Unit price	Qty	Unit price
31040005	3566837153779	Spa SP-3.17 SB, marbled white, grey composite	1	6,800.00	2	6,460.00	4	6,120.00

SPA COMMISSIONING

Code	EAN13	Description	Unit price
92346	3566835527619	Commissioning a spa	PAO

SPA DELIVERY

Code	EAN13	Description	Unit price
31090400	3566835483854	Delivery/ pick-up of a spa	POA

Transport costs are quoted net of any discount.

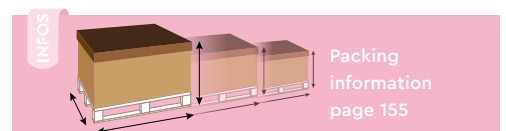

- PORTABLE VERSION
- 4 MASSAGE STATIONS
- 2 LOUNGERS
- 2 BUCKET SEATS
- 31 MASSAGE JETS



JET FINISH, PVC



COMPOSITE GREY SURROUND



MARBLED WHITE



DIVERTING VALVE

BUCKET SEAT

Shoulders: 4 directional jets, 95mm
 Back: 3 directional jets, 70mm
 Lower back : 2 directional jets, 70mm

AIR CONTROLS

LOUNGER

Shoulders: 2 directional jets, 95mm
 Back: 2 directional jets, 95mm
 Lower back : 2 directional jets, 95mm

AIR CONTROLS

DIGITAL CONTROL PAD

LED UW LIGHT

LOUNGER

Neck: 2 directional jets, 70mm
 Shoulders: 3 rotating jets, 95mm
 Back: 2 rotating jets, 95mm
 Lower back : 2 directional jets, 70mm

**SKIMMER
(2 CARTRIDGES)**

BUCKET SEAT

Shoulders: 2 dual-rotating jets, 95mm
 Back: 1 dual rotating jet, 95mm
 Lower back : 2 dual rotating, 95mm
 Calves: 2 directional jets, 70mm

AIR CONTROLS

DIVERTING VALVE



ACCESSORIES INCLUDED WITH THE SPA:



WEIGHT/ VOLUME/ DIMENSIONS/ FLOW RATES

- » Empty weight: 300Kg / Full weight: 1,300Kg / Water volume: 1,000 litres
- » Portable version: 200cm (L) x 200cm (W) x 80cm (H)
- » Removable step: 78,5cm (L) x 57.5cm (W) x 50cm (H)
- » Jet and spa pack flow rate: 52m³/h

EQUIPMENT

- » 1 Colour LED underwater light
- » 1 Skimmer (2 cartridges, 3.2m²)
- » 4 Head rests
- » 1 Rigid cover
- » 3 Main drains
- » 1 Spa pack:
 - 1 electrical panel with 1 electric heater (2 kW)
 - 1 Massage pump
- » 1 Two tread step

4 MASSAGE STATIONS, 31 MASSAGE JETS



5 Dual rotating jets, 95mm



5 Rotating jet, 95mm



6 Directional jets, 95mm



15 Directional jets, 70mm

SPA

Code	EAN13	Description	Qty	Unit price	Qty	Unit price	Qty	Unit price
31140205	3566837153786	Spa SP-4.31 SB, marbled white, grey composite	1	8,500.00	2	8,075.00	4	7,650.00

SPA COMMISSIONING

Code	EAN13	Description	Unit price
92346	3566835527619	Commissioning a spa	POA

SPA DELIVERY

Code	EAN13	Description	Unit price
31090400	3566835483854	Delivery/ pick-up of a spa	POA

Transport costs are quoted net of any discount.

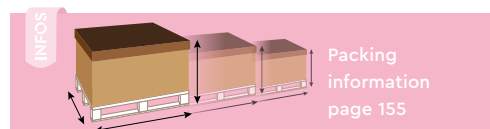

PORTABLE VERSION
5 MASSAGE STATIONS
5 BUCKET SEATS
32 MASSAGE JETS



JET FINISH,
PVC



COMPOSITE GREY
SURROUND



MARBLED WHITE

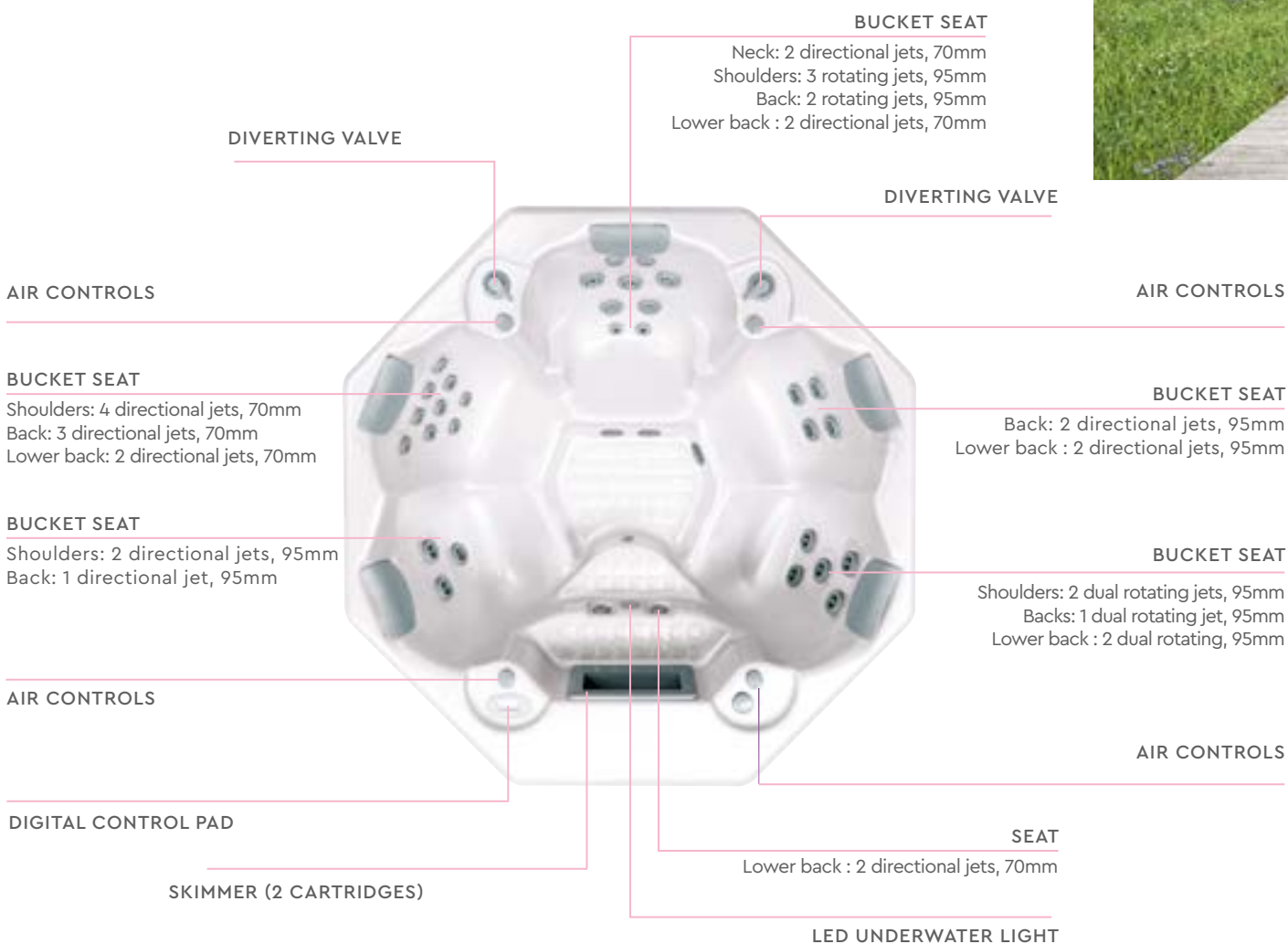

ACCESSORIES INCLUDED WITH THE SPA:



WEIGHT/ VOLUME/ DIMENSIONS/ FLOW RATES

- » Empty weight: 300Kg / Full weight: 1,400Kg / Water volume:1,100 litres
- » Portable version: 200cm (L) x 200cm (W) x 83cm (H)
- » Removable step: 78.5cm (L) x 57.5cm (W) x 50cm (H)
- » Jet and spa pack flow rate: 52m³/h

EQUIPMENT

- » 1 Colour LED underwater light
- » 1 Skimmer (2 cartridges, 3.2m²)
- » 5 Head rests
- » 1 Rigid cover
- » 3 Main drains
- » 1 Spa pack:
 - 1 electrical panel with 1 electric heater (2 kW)
 - 1 Massage pump
- » 1 Two tread step

5 MASSAGE STATIONS, 32 MASSAGE JETS



5 Dual rotating jets, 95mm



5 Rotating jet, 95mm



7 Directional jets, 95mm



15 Directional jets, 70mm

SPA

Code	EAN13	Description	Qty	Unit price	Qty	Unit price	Qty	Unit price
31240205	3566837153809	Spa SP-5.32 SB, marbled white, grey composite	1	8,550.00	2	8,122.50	4	7,695.00

SPA COMMISSIONING

Code	EAN13	Description	Unit price
92346	3566835527619	Commissioning a spa	POA

SPA DELIVERY

Code	EAN13	Description	Unit price
31090400	3566835483854	Delivery/ pick-up of a spa	POA

Transport costs are quoted net of any discount.

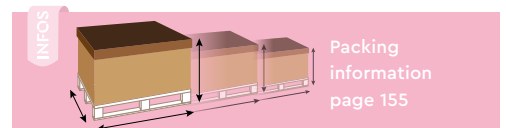

- PORTABLE VERSION
- 7 MASSAGE STATIONS
- 1 LOUNGER
- 2 BUCKET SEATS
- 1 BENCH, 4 SEATS
- 36 MASSAGE JETS



JET FINISH, PVC



COMPOSITE GREY SURROUND



MARBLED WHITE



AIR CONTROLS

LOUNGER

- Neck: 2 directional jets, 70mm
- Shoulders: 3 rotating jets, 95mm
- Neck: 2 rotating jets, 95mm
- Lower back: 2 directional jets, 70mm

LED UNDERWATER LIGHT

DIGITAL CONTROL PAD

AIR CONTROLS

SKIMMER (2 CARTRIDGES)

BUCKET SEAT

- Shoulders: 4 directional jets, 70mm
- Back: 3 directional jets, 70mm
- Lower back : 2 directional jets, 70mm



**BENCH
4 SEATS**

- Position 1
 - Neck: 1 directional jet, 95mm
 - Lower back: 1 directional jet, 95mm
- Position 2
 - Neck: 1 directional jet, 95mm
 - Lower back: 1 directional jet, 95mm
- Position 3
 - Neck: 1 directional jet, 95mm
 - Lower back: 1 directional jet, 95mm
- Position 4
 - Neck: 1 directional jet, 95mm
 - Lower back: 1 directional jet, 95mm

BUCKET SEAT

- Shoulders: 2 dual rotating jets, 95mm
- Back: 1 dual rotating jet, 95mm
- Lower back : 2 dual rotating, 95mm
- Hands: 2 directional jets, 70mm

AIR CONTROLS

DIVERTING VALVE

LED UW LIGHT

ACCESSORIES INCLUDED WITH THE SPA:

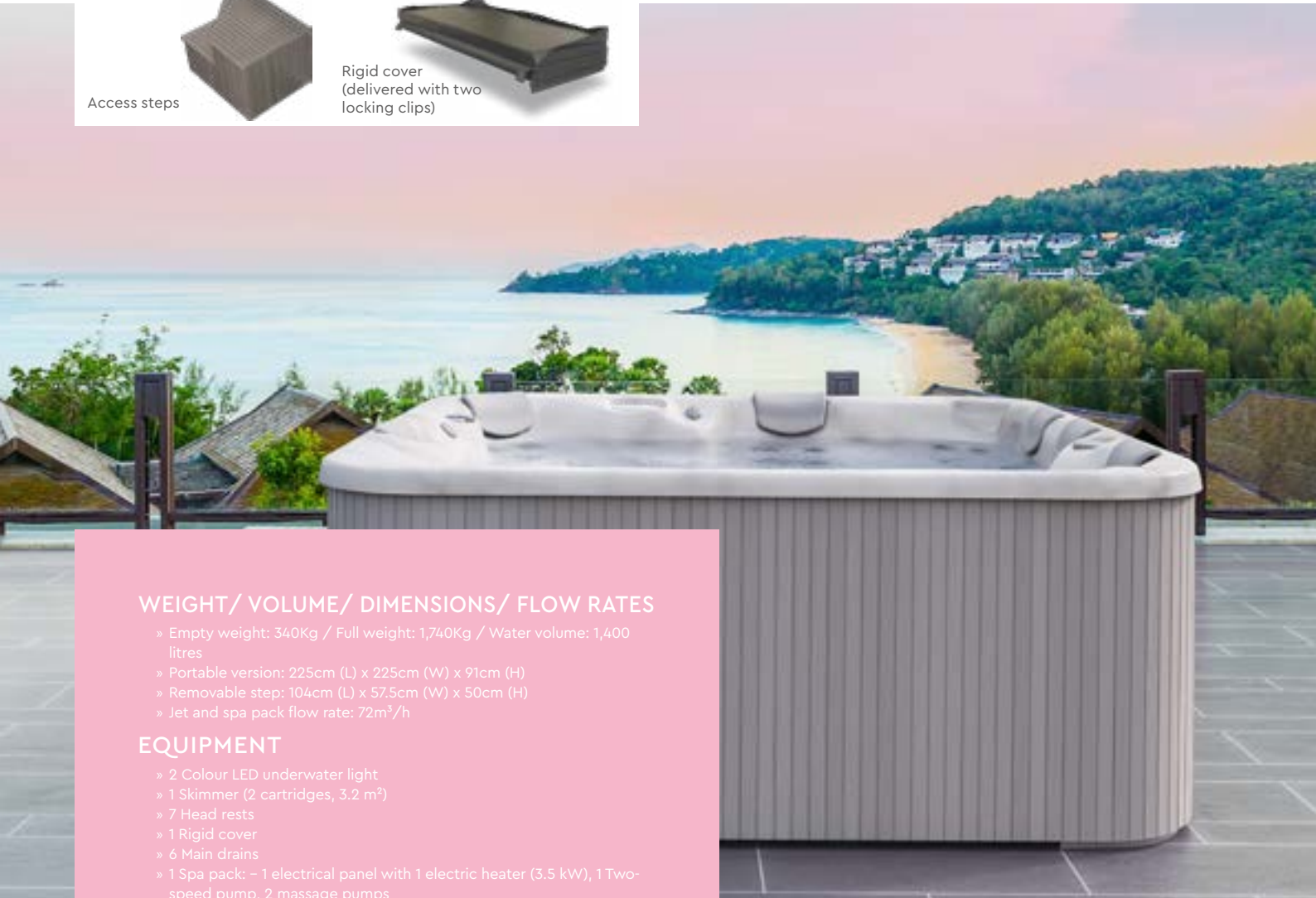

WEIGHT/ VOLUME/ DIMENSIONS/ FLOW RATES

- » Empty weight: 340Kg / Full weight: 1,740Kg / Water volume: 1,400 litres
- » Portable version: 225cm (L) x 225cm (W) x 91cm (H)
- » Removable step: 104cm (L) x 57.5cm (W) x 50cm (H)
- » Jet and spa pack flow rate: 72m³/h

EQUIPMENT

- » 2 Colour LED underwater light
- » 1 Skimmer (2 cartridges, 3.2 m²)
- » 7 Head rests
- » 1 Rigid cover
- » 6 Main drains
- » 1 Spa pack: - 1 electrical panel with 1 electric heater (3.5 kW), 1 Two-speed pump, 2 massage pumps
- » 1 Two tread step

7 MASSAGE STATIONS, 36 MASSAGE JETS



5 Dual rotating jets, 95mm



5 Rotating jet, 95mm



11 Directional jets, 95mm



15 Directional jets, 70mm

SPA

Code	EAN13	Description	Qty	Unit price	Qty	Unit price	Qty	Unit price
31440405	3566837153793	Spa SP-7.36 SB, marbled white, grey composite	1	13 200,00	2	12 540,00	4	11 880,00

SPA COMMISSIONING

Code	EAN13	Description	Unit price
92346	3566835527619	Commissioning a spa	POA

SPA DELIVERY

Code	EAN13	Description	Unit price
31090400	3566835483854	Delivery/ pick-up of a spa	POA

Transport costs are quoted net of any discount.

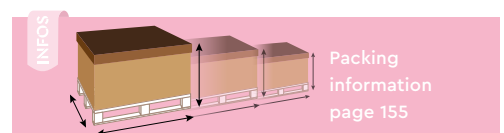

SPA COVERS



Code	EAN13	Description	Qty	Unit price
31893069	3566837157326	Cover for the Antarès SP-2.18 spa	1	379.00
31993269	3566837157319	Cover for the Antarès SP-5.23 spa	1	472.00
31590269	3566837157333	Cover for the SP-2.18 spa	1	386.00
31090269	3566837157371	Cover for the SP-3.17 spa	1	443.00
31190269	3566837157364	Cover for the SP-4.31 spa	1	463.00
31290269	3566837157357	Cover for the SP-5.32 spa	1	451.00
31490269	3566837157340	Cover for the SP-7.36 spa 1	1	553.00

SPA WATER TREATMENT CHEMICALS

1



SPA DISINFECTANT:
Active oxygen destroys bacteria and eliminates organic impurities in the water.

2



SPA ANTI-FOAMING AGENT:
Prevents foaming in the spa.

3



START-UP KIT:
The start-up kit comprises :
 » 1 Anti-foaming agent
 » 1 disinfectant
 » 1 PH plus
 » 1 PH minus,
 » 10 test strips,
 » 1 dosing jug and 1 instruction booklet.

	Code	EAN13	Description	Pages
1	8995950	3661931270558	Senet spa - Oxygene actif 20g, 1kg	43
2	8995940	3661931274099	Senet spa - Anti-mousse, 1L	43
3	8995970	3661931256538	Senet spa - Kit de demarrage	43

SPA SKIMMER CARTRIDGES



Code	EAN13	Description	Qty	Unit price	Qty	Unit price	Qty	Unit price
SPAS ANTARES AND SPA SP-2.18								
31090208	3566837157760	Skimmer filter cartridge SF-1C for spa	1	55.20	18	52.44	54	49.68
SPAS SP-3.17, SP 4.31, SP 5.32 AND SP 7.36								
31090207	3566837157753	Skimmer filter cartridge SF-2C for spa, set of 2	1	104.40	12	99.18	48	93.96

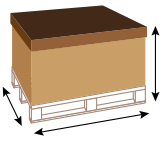

SPA LOGISTICS DATA

Code	Modèle	Pack	Length (cm)	Width (cm)	Height (cm)	Weight (kg)	Total weight (kg)
31840805	SP-Antares-2.18 spa, marbled white, composite grey	Spa	223	187	100	230	280
		Spa pack	120	80	69	50	
31940805	SP-Antares-5.23 spa, marbled white, composite grey	Spa	220	210	115	320	370
		Spa pack	120	80	69	50	
31540805	SP-2.18 SB spa, marbled white, composite grey	Spa	223	187	100	230	280
		Spa pack	120	80	69	50	
31040005	SP-3.17 SB spa, marbled white, composite grey	Spa	223	187	115	250	300
		Spa pack	120	80	69	50	
31140205	SP-4.31 SB spa, marbled white, composite grey	Spa	220	210	115	290	350
		Spa pack	120	80	69	60	
31240205	SP-5.32 SB spa, marbled white, composite grey	Spa	220	210	120	290	350
		Spa pack	120	80	69	60	
31440405	SP-7.36 SB spa, marbled white, composite grey	Spa	242	228	126	320	390
		Spa pack	120	80	69	70	

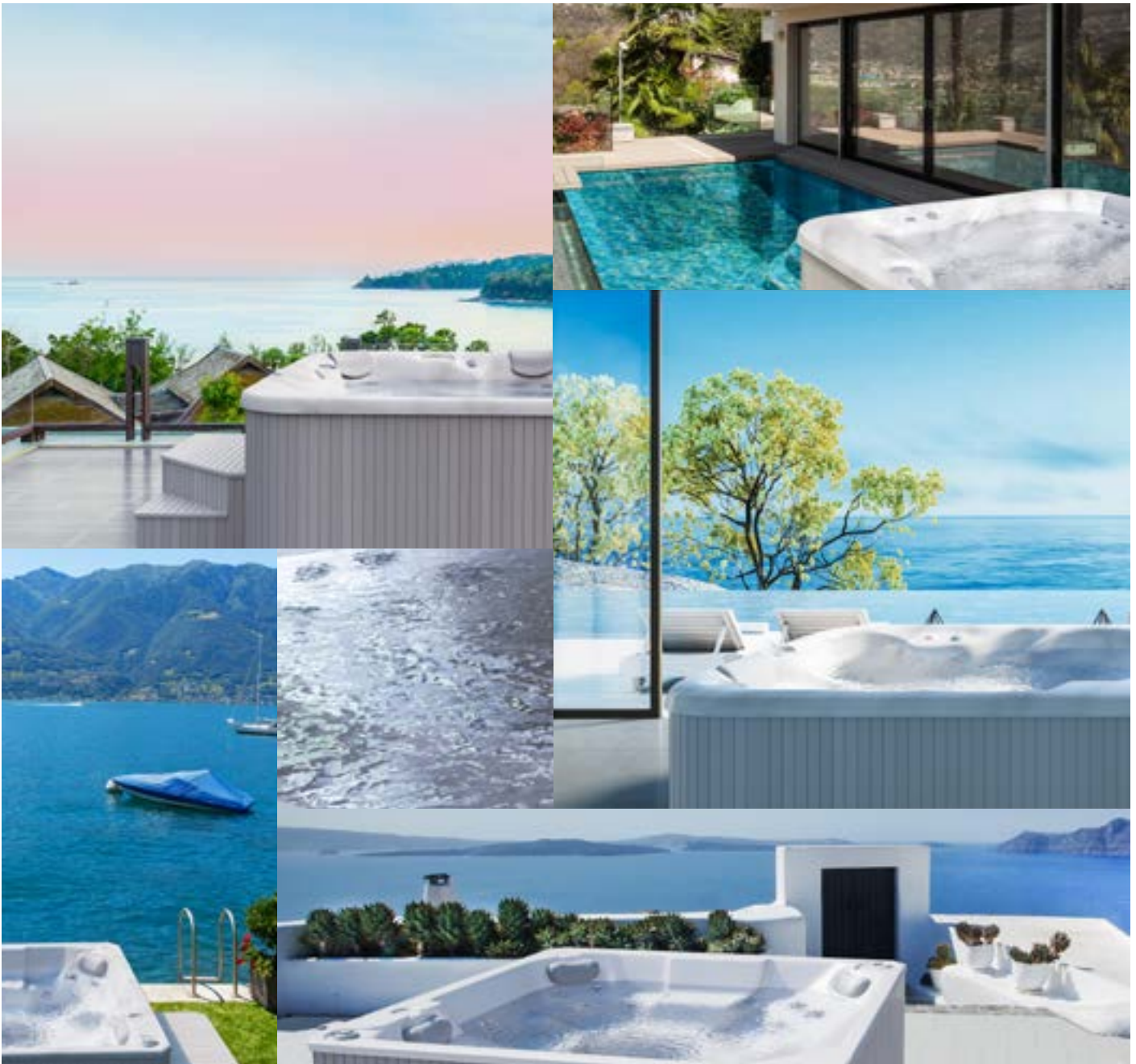





OS

BWT myPool Spare parts

PISTOCHE ABOVE-GROUND POOL	158
URBAN POOLS	159
FILTERS	160
UNIONS	161
PUMPS	162
UNDERWATER LIGHTS	164
SKIMMERS	165
FILTRATION UNIT	166
STEPS	167
CLEANING	168
COPING	170
WOODEN STRUCTURES	173
SPAS	176

PISTOCHE ABOVE-GROUND POOL

PISTOCHE SPARE PARTS

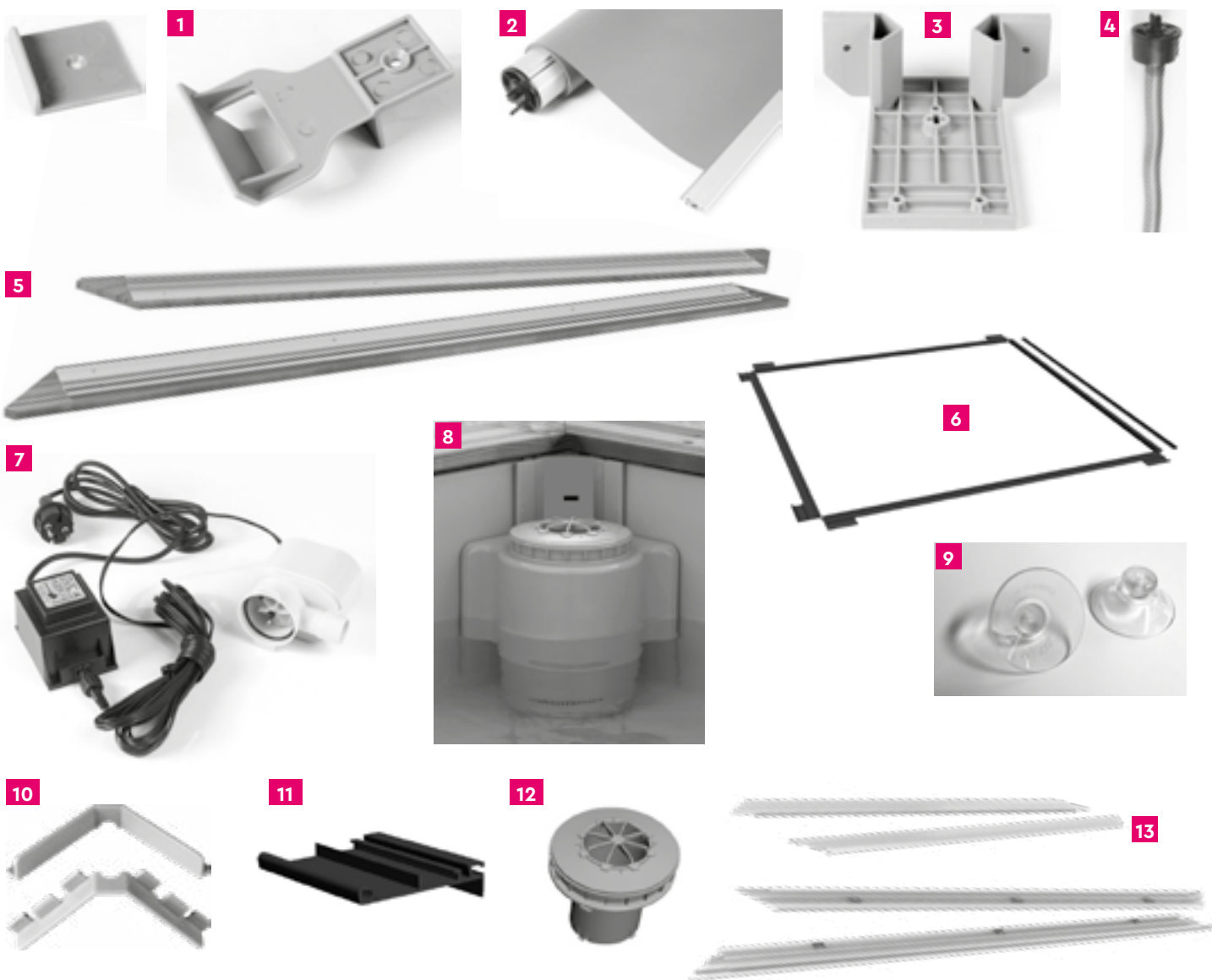

No.	Code	EAN 13	Description	Unit price
1	27940092	3566837166250	Safety stops and hooks for the safety cover, Pistoche	8.20
2	27940097	3566837166304	Safety cover and roller, Pistoche	167.90
3	27940091	3566837166243	Safety cover roller flange, Pistoche, set of 2	11.60
4	27940090	3566837164782	Safety cover roller spring, Pistoche	23.10
5	27940093	3566837166267	Pine coping with Hung alu, Pistoche, set of 2	117.90
6	27940094	3566837166274	Hung PVC, Pistoche	84.80
7	27940095	3566837166281	Filtration pump, Pistoche	72.90
8	27940096	3566837166298	Cartridge filter, Pistoche	193.30
9	27940098	3566837200091	Pistoche filter suction cup, set of 2	2.98
10	27940099	3566837209353	Pistoche liner corner block, blue, set of 4	3.69
-	5491059	3566837179342	Underlay for Pistoche 2x2m	16.60
-	72506100	3566837158569	Liner P-50, Pistoche, 2x2, H=68, Dark blue	Dimensions (m) : 2.00 x 2.00 x 0.68 80.80
11	27940088	3566837232511	Pistoche, set of 6 PVC Hung, 150mm	9.70
12	27940089	3566837223328	Pistoche filter floating skimmer	20.40

No.	Code	EAN 13	Description	Unit price
11	27920555	3566837206055	Pistoche alu coping retrofit kit	119.00
11	27920560	3566837206048	Pistoche expo pre 2017 retrofit kit	227.00

SPARE PARTS FOR URBAN POOLS

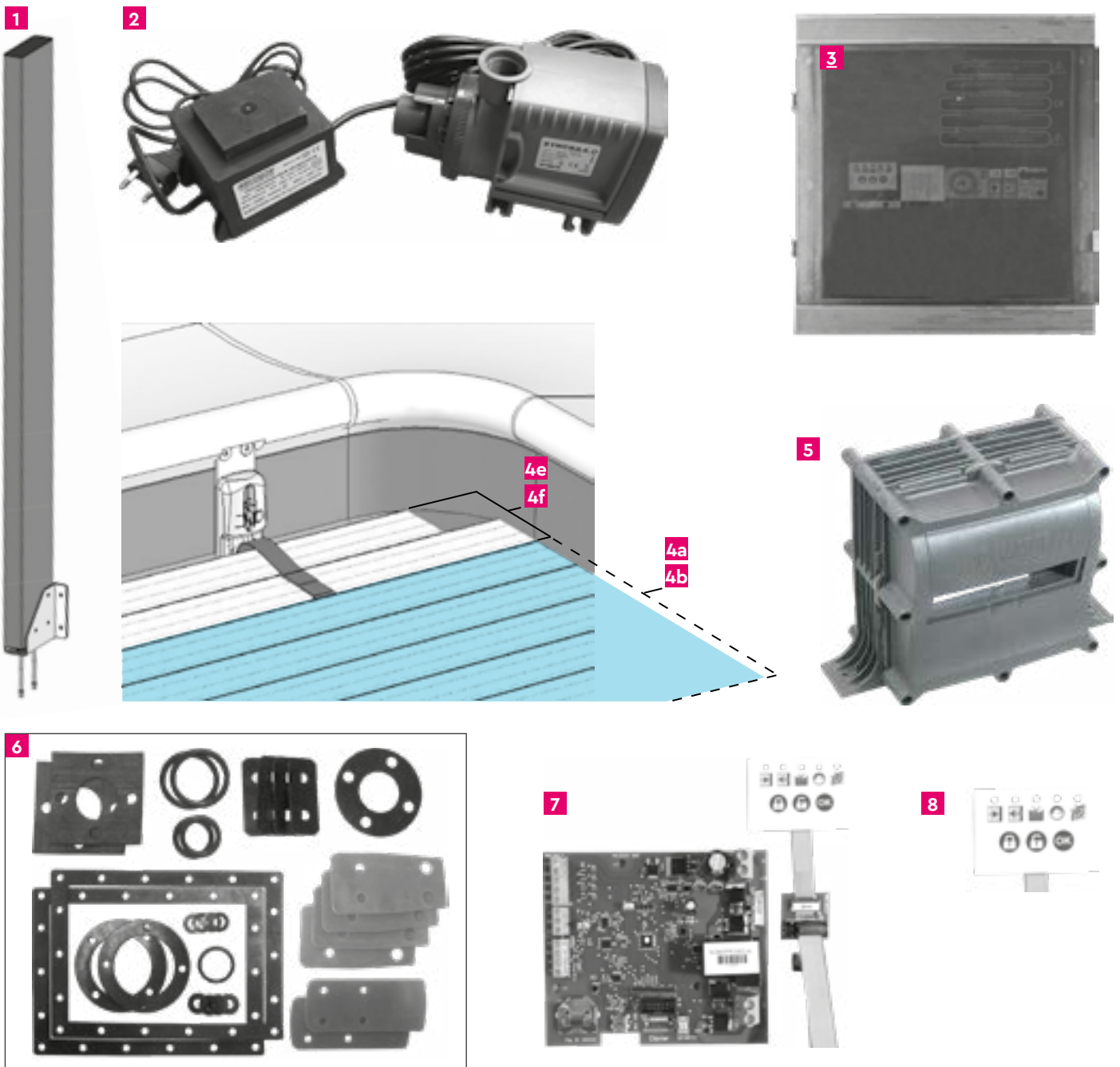

No.	Code	EAN 13	Description	Unit price
1	27900302	3566837210991	Reinforcing brace with shoe, set of 4, Urban pools	254.00
2	27931850	3566837199289	Urban pool pump, 50hz, with transformer	346.00
3	27931851	3566837209414	Urban pool control unit	760.00
4a	32000864	3566837190095	Set of 6 grey slats, Urban Pools, 4.2x3.5	94.00
4b	32000865	3566837190088	Set of 6 grey slats, Urban Pools, 6x2.5	70.80
4c	32000866	3566837190071	Set of 2 grey slats, Urban Pools, axle side, 4.2x3.5	65.90
-	32000867	3566837190064	Set of 2 grey slats, Urban Pools, axle side, 6x2.5	54.20
-	32000868	3566837190057	Set of 2 grey slats, Urban Pools, pool end, 4.2x3.5	67.30
4f	32000869	3566837190040	Set of 2 grey slats, Urban Pools, pool end, 6x2.5	55.50
5	32276053	3566837220952	Urban pool motor	805.00
6	32206060	3566837211370	Urban pool, set of seals	34.70
7	32276065	3566837188801	Urban pool, PCB with lexan	256.00
8	38270067	3566837233501	Lexan for printed circuit board	67.60
-	32690850	3566837233280	Mini UW light, 12 LEDs, white, Urban pools	130.00

P-FI, P-FS AND P-FS E FILTERS

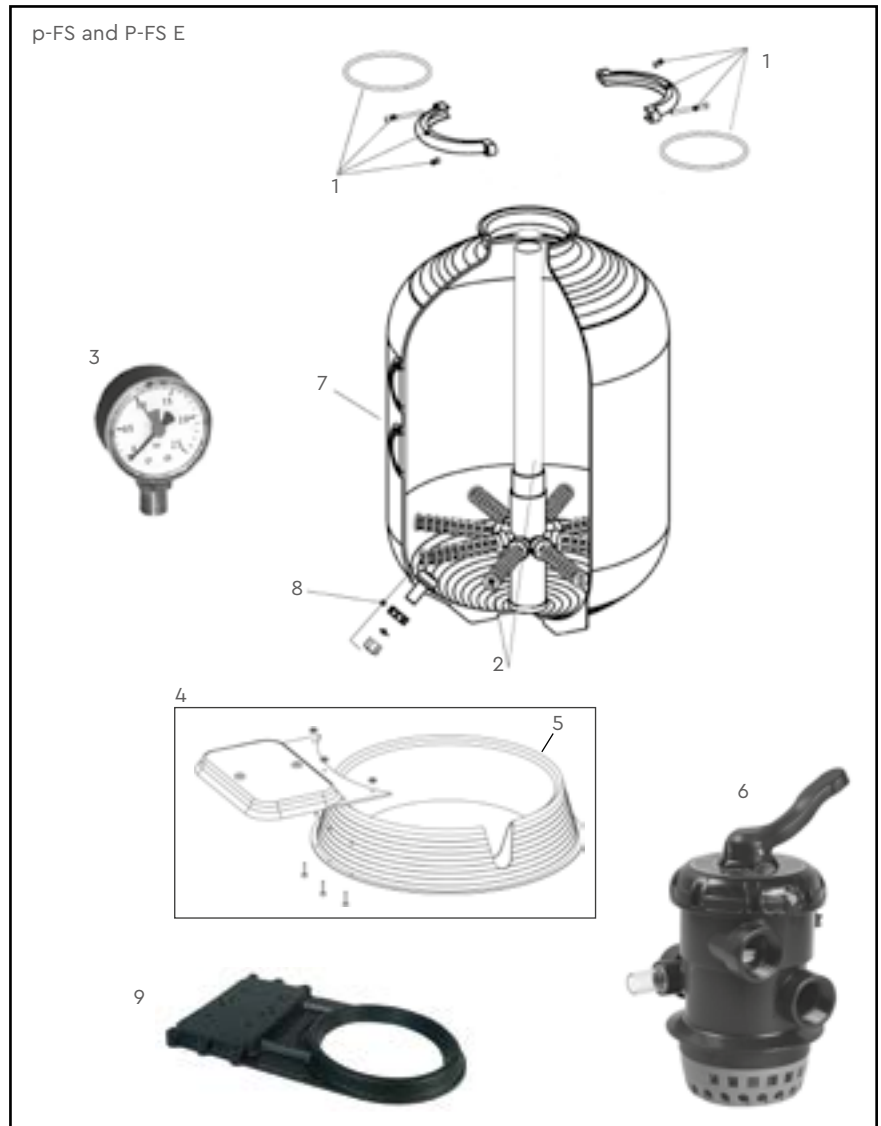
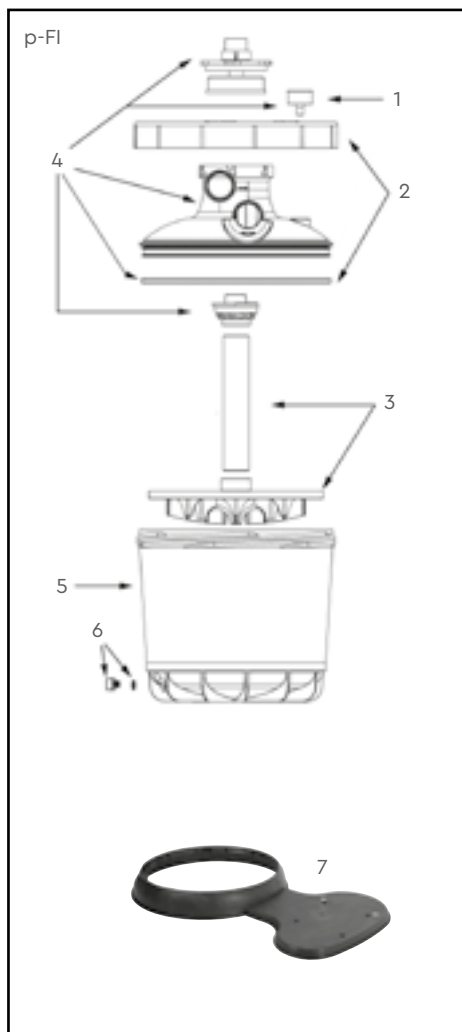

No.	Code	EAN 13	Description	Unit price
P-FI FILTER				
1+6	20900003	3566837068035	P-FI 400/500 filter fittings. wooden pools	19.90
2	20900004	3566837068028	P-FI 400 filter retaining ring	41.30
2	20900211	3566837067960	P-FI 500 filter retaining ring	60.10
3	20900006	3566837068011	P-FI 400 collector hub	41.90
3	20900210	3566837067977	P-FI 500 collector hub	53.40
4	20900150	3566837156671	P-FI 400 filter lid	125.40
4	20900250	3566837156688	P-FI 500 filter lid	138.20
5+6	20905800	3566837108410	P-FI 400 filter tank with drain	61.60
5+6	20905900	3566837108427	P-FI 500 filter tank with drain	70.30
6	20909920	3566837015695	P-FI 400 /500 cap for lower drain. set of 2	6.90
7	20900008	3566837068004	Socle complet P-FI 400/500	31.00
P-FS AND P-FS E FILTERS				
1	27931254	3566837067830	P-FS 500EH/610 filter collar clamp	26.30
2	27931350	3566835472841	P-FS 500 EH filter collector with laterals	64.40
2	27931450	3566835475767	500-610 filter collector with laterals	68.80
3+7	27931156	3566837067847	500EH/610 filter drain and pressure gauge	33.40
4	27931157	3566837067724	P-FS 500 filter base, wooden pools	75.90
5	300102	3566831005272	P-FS sand filter base*	17.40
6	27931250	3566837109165	Top valve with collar clamps for 500EH/610 filters	105.80
7+8	27931251	3566837109172	P-FS 500EH filter tank with drain	179.40
7+8	27931252	3566837109189	P-FS 610 filter tank with drain	165.20
9	520390	3566831124577	P-GFS 400 sand filter base	7.60

BWT MYPOOL UNIONS



No.	Code	EAN 13	Description	Unit price
1+2	27931351	3566835473619	Suction module, RC45, wooden pools	67.40
2+5	27931052	3566835475750	Pump-filter module/Filter 400 Basic - Diameter 38, Length 37cm	24.90
2+5	27931053	3566837109981	Pump-filter module/Filter400 Tropic - Diameter 38, Length 50cm	32.20
2+5	27931152	3566837067755	Pump-filter module/ blow moulded 400 - Diameter 45, Length 35cm	28.50
2+5	27931253	3566837067694	Pump-filter module/ blow moulded 500 - Diameter 45, Length 55cm	31.60
2+5	27931352	3566837067700	Pump-filter module/ blow moulded 500 EH - Diameter 45, Length 65cm	32.50
2+7	27931453	3566835483267	Y-RC45 return module, GF-4, Odyssea rectangle	60.90
2+6	27931153	3566837067779	Return module, hose tail, Weva/Odyssea - Diameter 45	102.30
2+3+4	27931154	3566837067748	P-FI filter return valve module	61.20
2+3+4	27931354	3566837067731	P-FS filter return valve module	52.20
2+8	27931355	3566835475743	P-AP pump suction valve module	59.90
2+8	27931455	3566837067717	P-AMX pump suction valve module	72.70

AQUA MINI PUMP - 4 (0.16 KW) - 6 (0.20 KW)

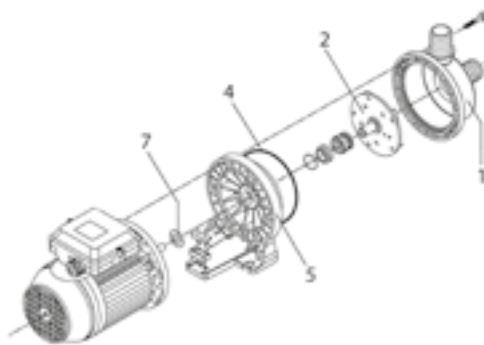

No.	Code	EAN 13	Description	Unit price
1a	50011001	3566835518310	Aqua Mini 4 pump volute*	50.00
1b	50021001	3566835518341	Aqua Mini 6 pump volute*	53.40
2a	50011005	3566835518358	Aqua Mini 4-pump impeller, 50Hz*	32.00
2b	50021005	3566835518365	Aqua Mini 6-pump impeller, 50Hz*	32.50
4	50011009	3566835518419	Aqua Mini pump seal plate flange gasket (101×3.5mm)	6.80
5	50011010	3566835518426	Aqua Mini pump seal plate*	32.10
7	50011013	3566835518433	Aqua Mini pump water slinger (45×12×4mm)	3.52

BWT MYPOOL P-AP PUMPS

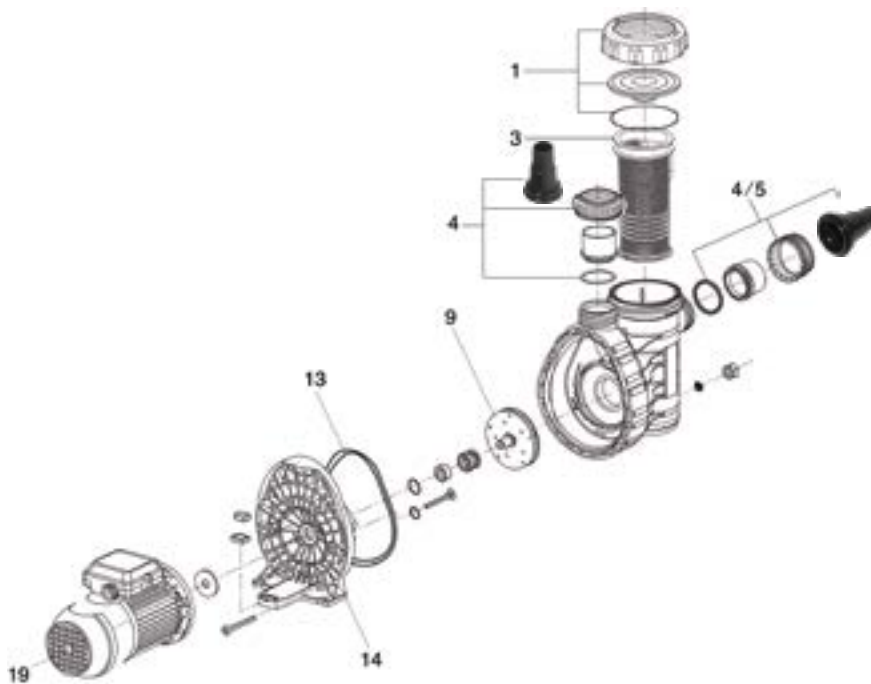

No.	Code	EAN 13	Description	Unit price
1	50211204	3566837067885	P-AP pump lid	74.70
3	50211207	3566835518495	P-AP pump prefilter basket	15.60
4	50211206	3566837068042	P-AP or AMX pump return port, D45	20.20
5	50211205	3566837067878	P-AP pump suction or return port, D38	28.50
8	50211210	3566835518518	P-AP pump volute	147.40
9a	50211212	3566835518525	P-AP 4 pump impeller	32.80
9b	50231212	3566835518549	P-AP 8 pump impeller	34.20
13	50211214	3566835518563	P-AP pump seal plate gasket (165×6mm)	8.80
14	50211215	3566835518570	P-AP pump seal plate	58.60
19	50241220	3566835526742	Fan cowling for pump P-AP 4-6-8	66.60
-	50211221	3566837038076	6mF capacitor for P-AP 4 pump	45.20
-	50221221	3566837038083	10 mF capacitor for Aqua Plus 6 pump	57.50
-	50231221	3566837038106	12 mF capacitor for Belstar/P-AP 8 pump	76.40
-	50241221	3566837038113	25 mF capacitor for P-AP 11 pump	94.00

BWT MYPOOL P-AMX PUMPS

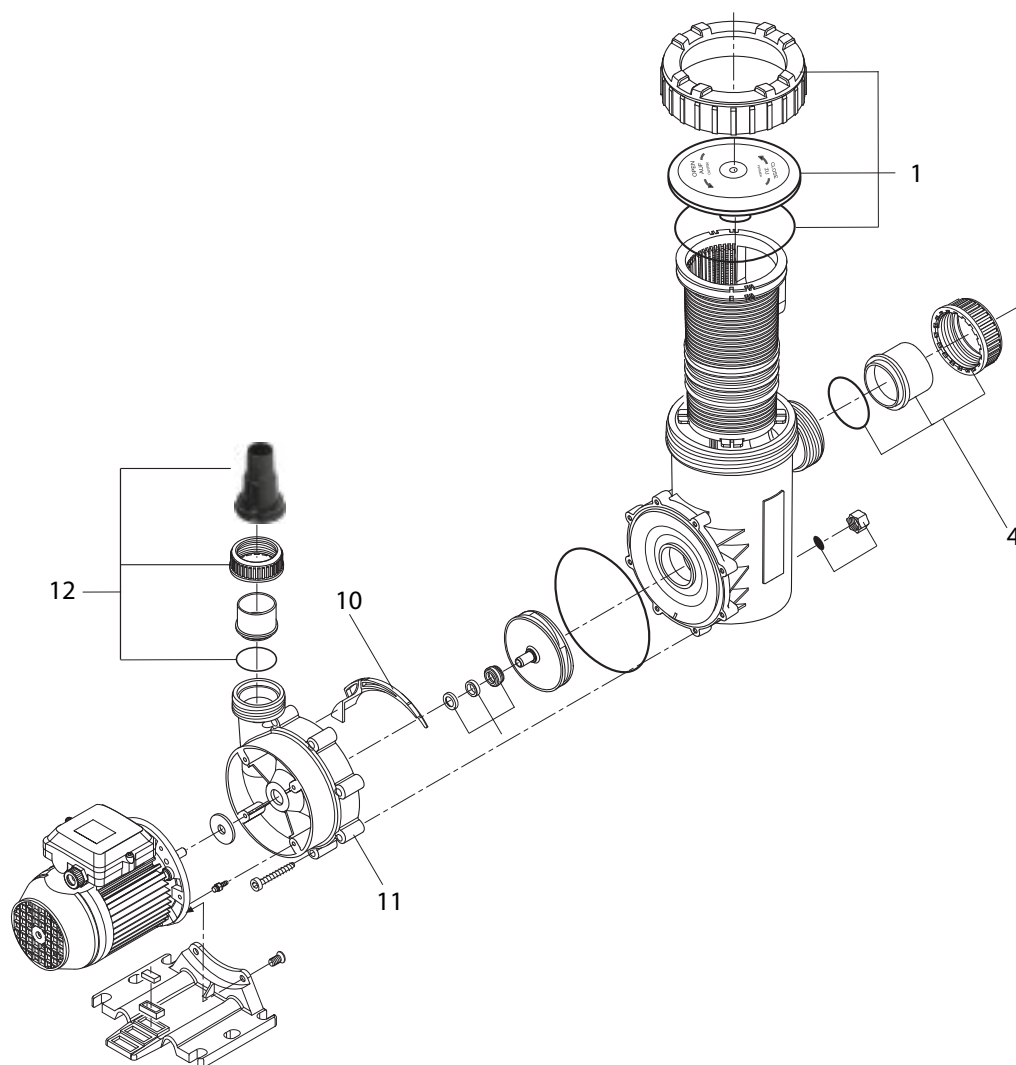

No.	Code	EAN 13	Description	Unit price
1	50311304	3566837067854	P-AMX pump lid	137.10
4	50311308	3566837210908	P-AMX pump union Ø63mm	13.00
10	50311328	3566837053147	P-AMX pump suction diffuser	23.50
11	50311307	3566837210830	P-AMX pump return body*	105.00
12	50211206	3566837068042	P-AP or AMX pump return, D45	19.60

UNDERWATER LIGHTS

50 W UNDERWATER LIGHTS FOR WOODEN POOLS

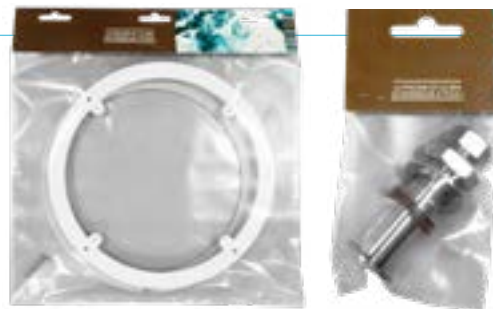
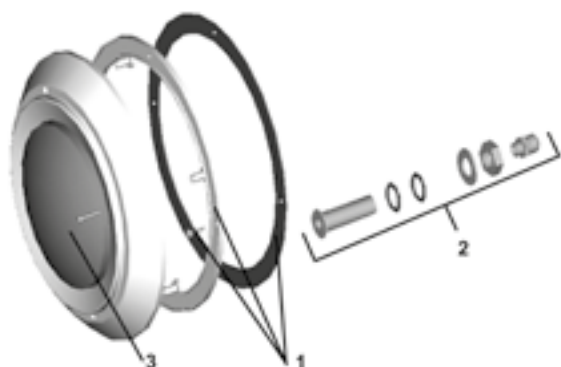

No.	Code	EAN 13	Description	Description
1	44450020	3566835503286	Extra flat UW light PH05 flange, gaskets and screws	51.90
2	44370040	3566835521655	Throughwall flange/ Ultra flat UW light, PH05-W	41.90
3	44350001	3566837162207	50 W bulb and guts pack for halogen UW light, PH05	85.50



BWT MYPOOL SKIMMER - POOL FITTINGS

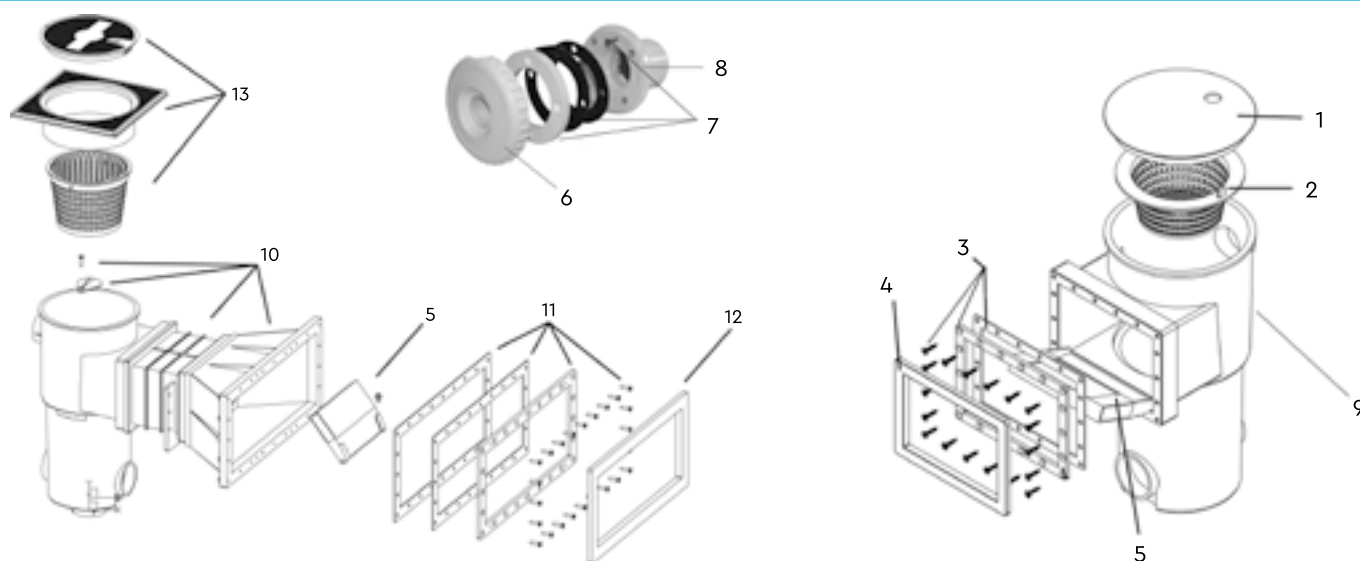

No.	Code	EAN 13	Description	Unit price
7	42000006	3566837068059	Return fitting flange, gaskets & screws	20.20
3	40021032	3566837067946	P-PM-Body skimmer flanges, gaskets & screws	20.80
11	40061032	3566837111045	P-GM-Body skimmer flanges, gaskets & screws	39.30
9	40322002	3566837110710	P-PM-Body skimmer body/ pool Octo & Octo+	60.70
10	40361002	3566837110727	P-GM-Long skimmer body and prefix flange/ rect pool	120.60
8	42306001	3566837110741	Return body RC38 outlet, w/insert & screws	17.00
8	42307001	3566837110734	Return body, outlet 2" or Female 50 with insert and screws	11.20
1+2	40021054	3566837067939	P-PM-Body skimmer basket and Skim Vac	36.40
13	40061054	3566837111052	P-GM-Body skimmer basket and Skim Vac	47.80
4+5+6	48404068	3566837067922	Set of trims, white, Weva Odyssea	25.90
4+5+6	48404268	3566837067915	Set of trims DB, Weva Odyssea, Octo & Octo+	27.70
4+5+6	48404568	3566837067908	Set of trims beige, Weva Odyssea, Octo & Octo+	27.10
4+5+6	48404868	3566837067892	Set of trims grey, Weva Odyssea, Octo & Octo+	29.70
5+6+12	48304000	3566837108281	Set of trims, white, Weva Odyssea Rect	48.90
5+6+12	48304200	3566837108298	Set of trims, DB, Weva Odyssea Rectangle	48.20
5+6+12	48304500	3566837108380	Set of trims, beige, Weva Odyssea Rect	46.80
5+6+12	48304800	3566837108403	Set of trims, light grey, Weva Odyssea Rect	50.60

SKIMMERS FOR ABOVE-GROUND POOLS, JET VAC AND MAGIC - SKIM

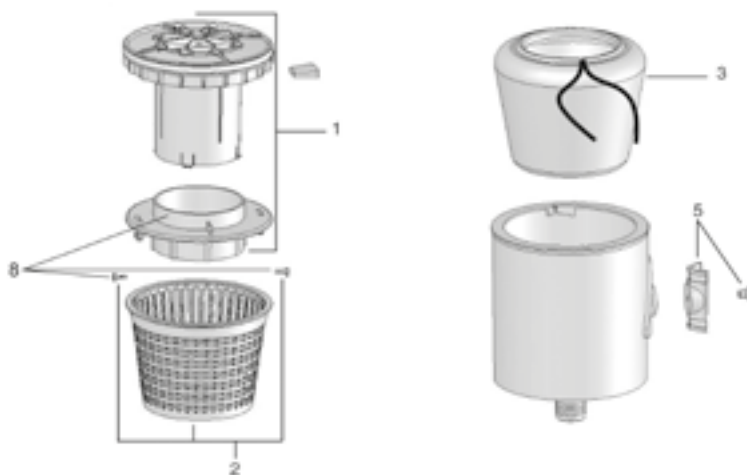

No.	Code	EAN 13	Description	Unit price
2	40500042	3566837202439	SF201-HS skimmer basket	7.20
5	40500041	3566835520030	SF201-HS floating skimmer v-shaped bracket+clamps	11.00
8	40500040	3566835520023	SF201-HS skimmer guide with clips	13.00

SOLIFLOW FILTRATION UNIT

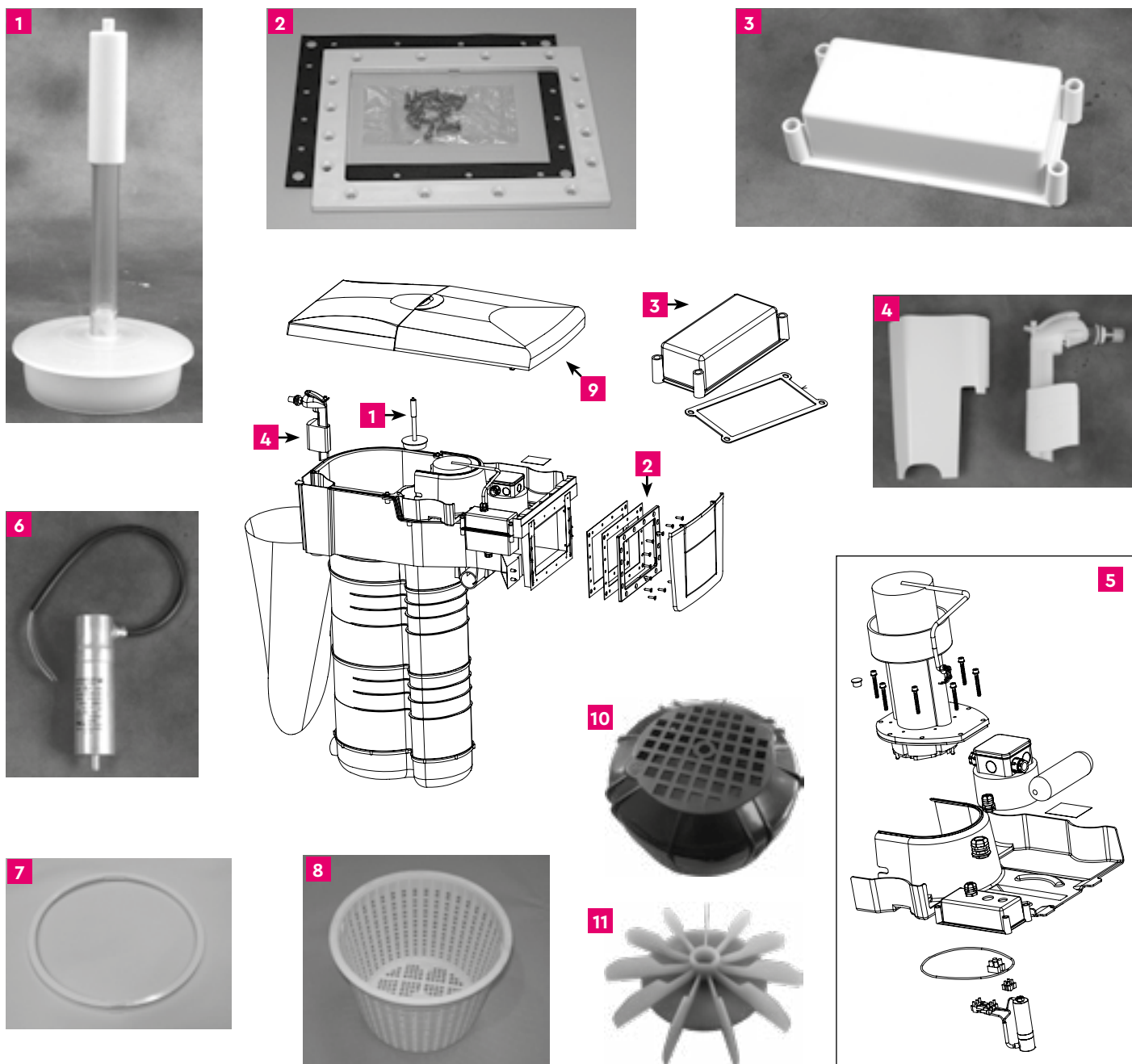

No.	Code	EAN 13	Description	Unit price
1	8491160	3566835522119	Soliflow clogging indicator	42.10
2	8491260	3566835522126	Soliflow mouth flange, gaskets & screws	26.70
3	8491360	3566835522133	Soliflow winterizing cover + gasket	11.80
4	8491460	3566835522140	Soliflow level regulator mechanism	41.80
5a	8494160	3566835522157	Soliflow 50 Hz retrofit kit, pre 2007*	694.00
5b	8494660	3566835524892	Soliflow 60 Hz retrofit kit, pre 2007*	754.00
6a	8494201	3566835451570	Soliflow pump capacitor VZ6 50Hz 8mF	22.40
6b	8494101	3566835453932	Soliflow pump capacitor VZ6 60Hz 6mF*	26.00
7	8493102	3566835452188	Soliflow flow lock	3.77
8	8493460	3566837045203	Soliflow filter basket	9.40
-	8492413	3566835464310	Soliflow MF cartridge gasket#	16.10
-	8494560	3566837170165	Autonomous filtration pump, 50Hz	476.00
9	8495160	3566837209407	Autonomous filtration sand cowl	360.00
10	8494104	3566837071066	Sirem 50Hz V06 pump fan cowl	19.00
11	8494106	3566837071073	Sirem 50Hz V06 pump fan	37.30

BILTMORE

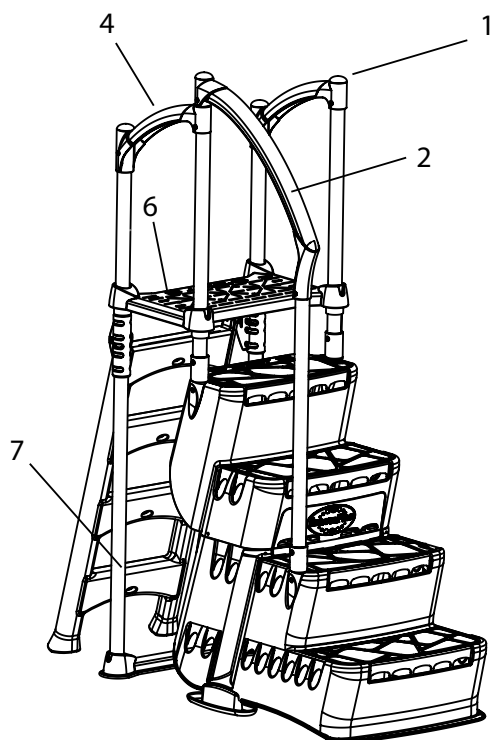

FIESTA

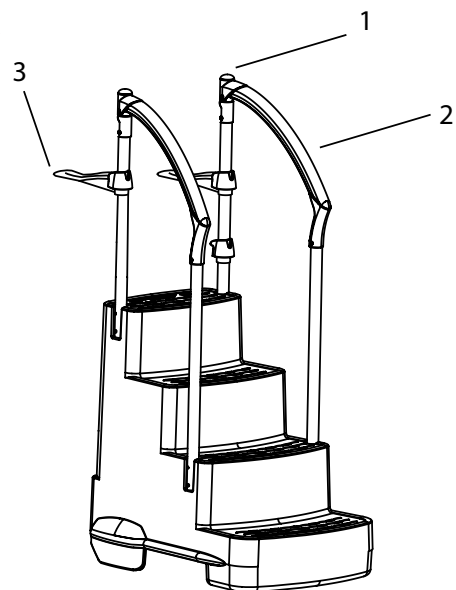

H2O

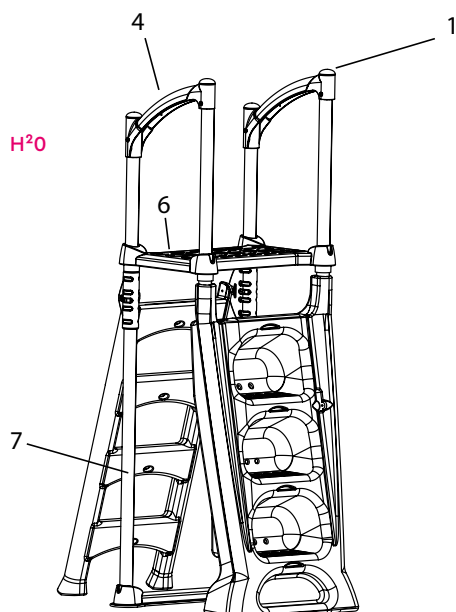

TUX

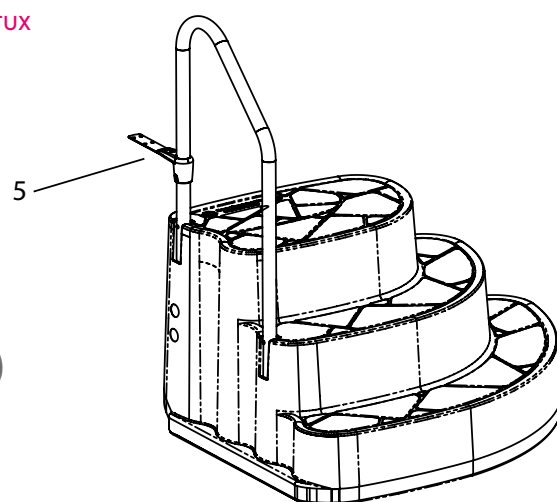

8

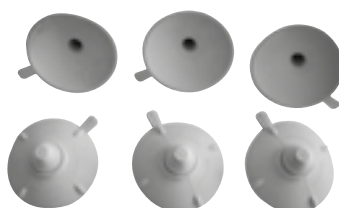

No.	Code	EAN 13	Description	Unit price
1	927301	3566837064716	Fiesta step cap, set of 2	13.80
2	927303	3566837064723	Biltmore/Fiesta step hand rail	86.00
3	927308	3566837064747	Biltmore/Fiesta deck support bracket	31.70
4	927703	3566837064761	H2O step hand rail	40.20
5	927108	3566837064808	Tux step deck support bracket	112.70
6	927501	3566837121297	Biltmore, H2O ladder platform	86.00
7	927502	3566837121310	Biltmore, H2O ladder hand rail	33.80
8	927310	3566837073145	Set of 6 suction cups for Fiesta steps	121.10
-	927305	3566837064730	Fiesta step screws	43.10
-	927505	3566837064754	Biltmore step screws, pool side	45.30
-	927705	3566837064778	H2O step screws, pool side	43.10
-	927706	3566837064785	H2O step screws, exterior side	41.40
-	927105	3566837064792	Tux step screws	43.10

CLEAN & GO E15 AND E20 ROBOTS

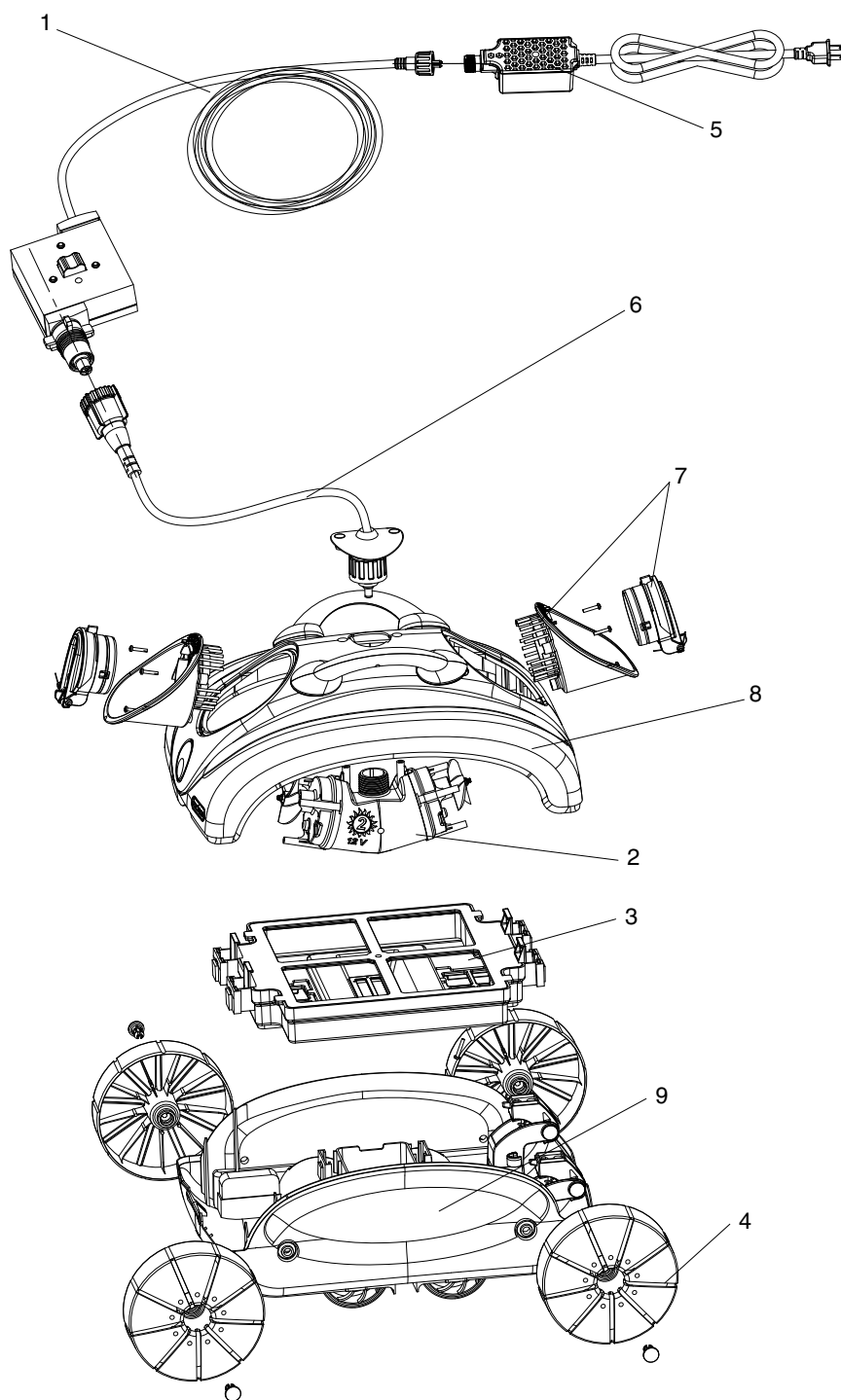

No.	Code	EAN 13	Description	Unit price
1a	1014101	3566837191535	Clean & Go E15 control box 7m floating cable*	43.70
1b	1014141	3566837191634	Clean & GoE20 control box 10m floating cable*	54.50
2	1014103	3566837191641	Clean & Go E15/20 motor block*	290.00
3a	1014105	3566837191559	Clean & Go E15 nylon basket*	11.40
3b	1014145	3566837191627	Clean & Go E20 SS basket*	12.90
4	1014106	3566837191566	Clean & Go E15 robot wheel, set of 4*	15.50
5	1014110	3566837191580	Clean & Go E15/E20 robot transformer*	40.60
6	1014111	3566837191597	Clean & Go E15/E20 robot floating cable,3m*	12.30
7	1014112	3566837191603	Clean & Go E15/E20 regulating valve*	8.30
8	1014113	3566837191610	Clean & Go E15/E20 top casing*	39.10
9	1014114	3566837191573	Clean & Go E15/E20 bottom casing*	53.50

JET VAC AUTOMATIC CLEANER

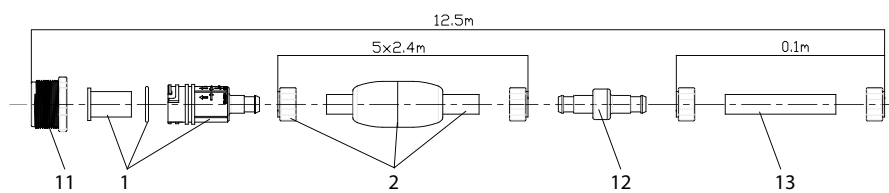
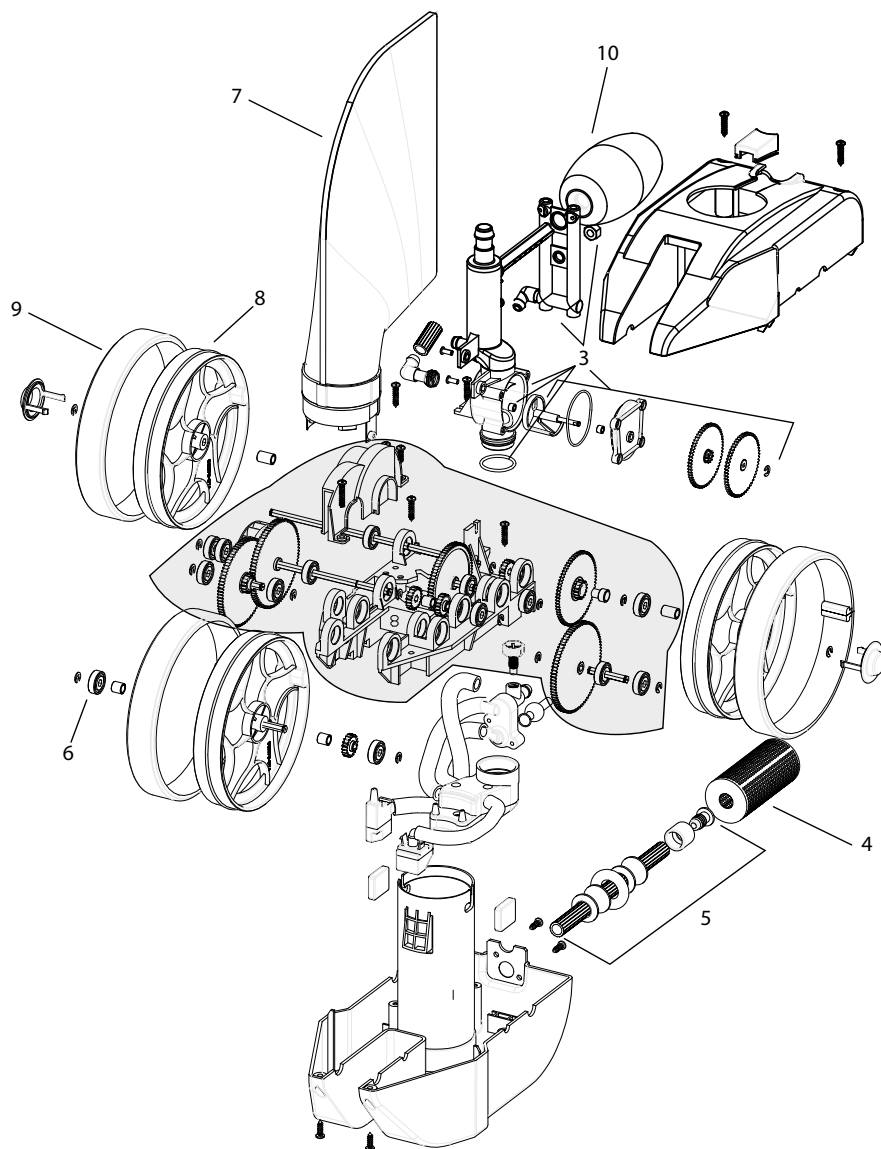

No.	Code	EAN 13	Description	Unit price
1	1004001	3566837086114	Jet Vac throughwall flange with pressure valve	14.00
2	1004002	3566837086138	Jet Vac hose	18.80
3	1004003	3566837086206	Jet Vac reverse gear kit	31.70
4	1004004	3566837089726	Jet Vac foam brush	5.60
5	1004005	3566837086145	Jet Vac sweep hose without brush	24.60
6	1004006	3566837086152	Jet Vac bearing	6.50
7	1004007	3566837086237	Jet Vac robot filter bag	18.50
8	1004008	3566837086244	Jet Vac robot wheel	12.90
9	1004009	3566837086251	Jet Vac robot tyre	10.10
10	1004010	3566837086268	Jet Vac robot float	7.00
11	1004011	3566837089733	Jet Vac vacuum fitting adapter	5.60
12	1004012	3566837089740	Jet Vac robot hose swivel union	9.00
13	1004013	3566837089757	Jet Vac robot flexible hose	5.60

COPING SIMPLE PINE - TROPIC

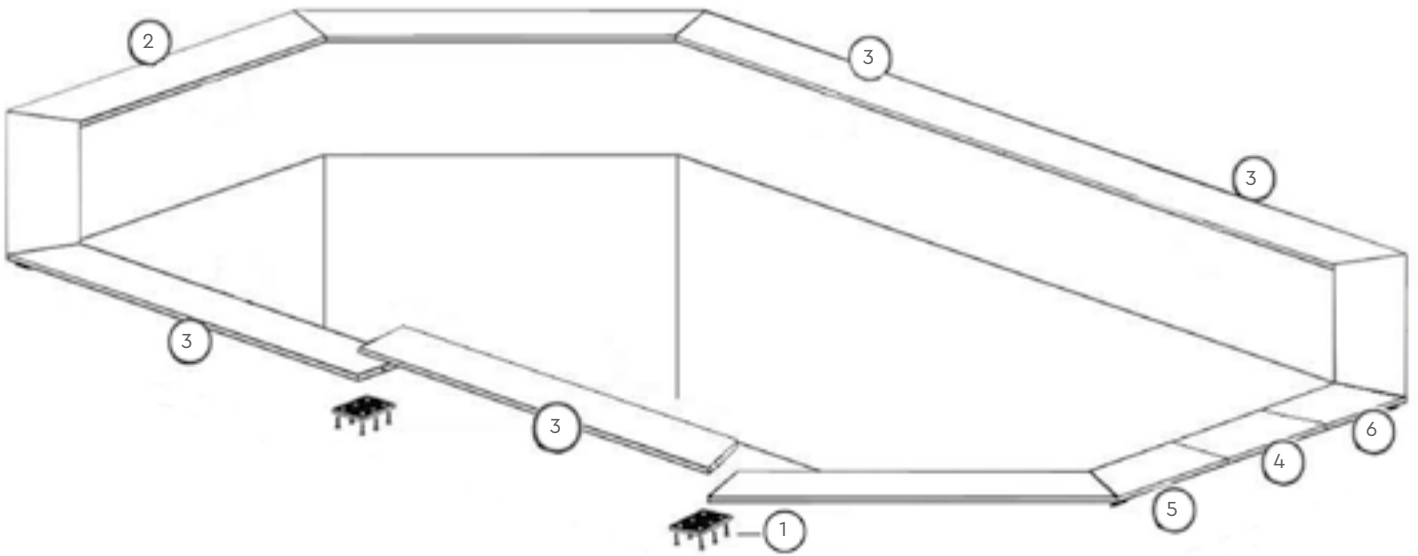

No.	Code	EAN 13	Description	Unit price
1	27921660	3566837109073	Pack, 9 brackets & mounting plates, Tropic Octo	119.80
1	27924660	3566837109080	Pack, 22 brackets & mounting plates, Tropic Octo+	249.00
4+5+6	27922052	3566837128128	Pack, simple pine coping, skimmer Tropic H410	87.80
2	27922053	3566837128173	Pack, 3 copings, 1990mm simple pine Tropic H410	213.00
2	27921650	3566837109066	Pack, 4 copings 1591mm, simple pine, Tropic 414	164.60
2	27922650	3566837109059	Pack, 4 copings, 1941mm simple pine Tropic 505	188.20
2	27924650	3566837109042	Pack, copings, 1289mm simple pine Tropic +460 +540	154.60
3	27924651	3566837109035	Pack, 4 copings, 1395mm simple pine Tropic +460	122.60
3	27923651	3566837128159	Pack, 4 copings, 1547mm simple pine Tropic +510	154.50
3	27925651	3566837109028	Pack, 4 copings, 1688mm simple pine Tropic +540	181.20
3	27927651	3566837109011	Pack, 4 copings, 1839mm simple pine Tropic +610	224.00
3	27926651	3566837128180	Pack, 4 copings, 1982mm simple pine Tropic +640	174.10
4+5+6	27921652	3566837108991	Pack, simple pine coping, skimmer Tropic 414 +510	77.90
4+5+6	27922652	3566837108984	Pack, simple pine coping, skimmer Tropic 505	84.20
4+5+6	27914652	3566837109004	Pack, simple pine coping, skimmer Tropic +460 +540	75.20

COPING SIMPLE PINE - WEVA

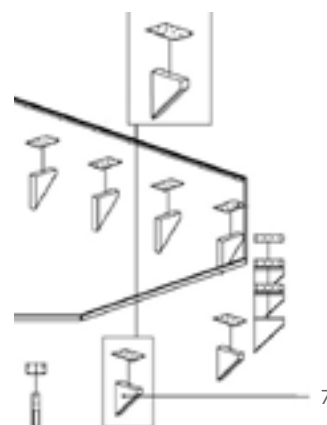
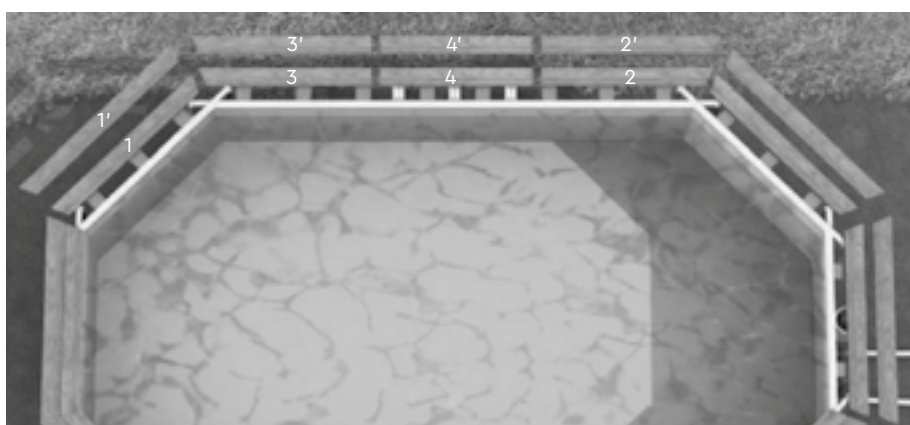
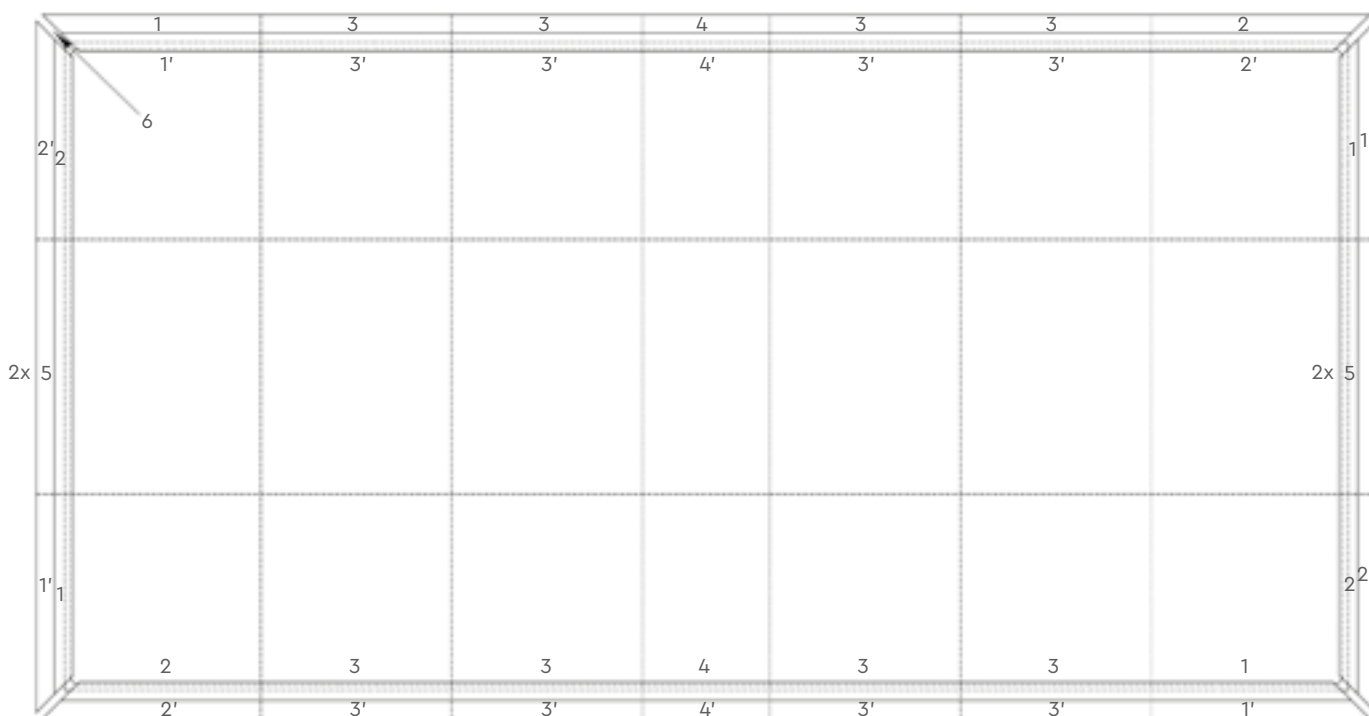

No.	Code	EAN 13	Description	Unit price
1+1'	27921750	3566837108717	Pack, 2 double width pine coping, Weva 440 +610 +640	145.10
1+1'	27924750	3566837108731	Pack, 2 double width pine coping, Weva +460 +540	161.10
1+1'	27922750	3566837108724	Pack, 2 double width pine coping, Weva 530 +840	164.40
2+2'	27924751	3566837108748	Pack, 2 R cut double pine copings, Weva +460	109.70
3+3'	27924752	3566837108755	Pack, 2 L cut double pine copings, Weva +460	109.80
2+2'	27925751	3566837108809	Pack, 2 R cut double pine copings, Weva +540	195.00
3+3'	27925752	3566837108816	Pack, 2 L cut double pine copings, Weva +540	182.40
2+2'	27926751	3566837108878	Pack, 2 R cut double pine copings, Weva +640+840	165.00
3+3'	27926752	3566837108885	Pack, 2 L cut double pine copings, Weva +640+840	165.10
2+2'	27927751	3566837108847	Pack, 2 R cut double pine copings, Weva +610	194.30
3+3'	27927752	3566837108854	Pack, 2 L cut double pine copings, Weva +610	194.30
4	27928751	3566837108861	Pack, 4 copings, 1500mm double pin Weva +840	107.60
1+1'	27924755	3566837108762	Pack, 2 L cut double pine copings, Weva Rect	146.80
2+2'	27924756	3566837108779	Pack, 2 R cut double pine copings, Weva Rect	146.60
6	27924757	3566837108786	Pack, 4 corner copings, double pine, Weva Rect	83.90
4	27926755	3566837108823	Pack, 2 copings, 1000mm, double pine, Weva Rect	74.40
3	27924758	3566837108793	Pack, 2 copings, 1499mm, double pine, Weva Rect	113.00
5	27926756	3566837108830	Pack, 2 copings, 1999mm, double pine, Weva Rect	107.80
7	27921760	3566837110611	Pack,12 brackets & mounting plates, / Octo	250.00
7	27924760	3566837110628	Pack,12 brackets & mounting plates, / Rect	250.00

COMPOSITE COPING - ODYSSEA

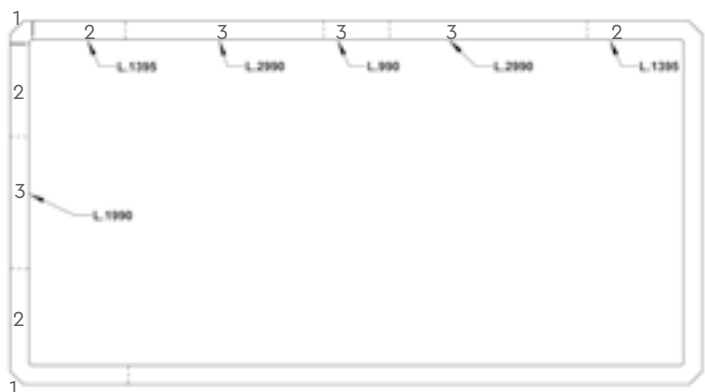
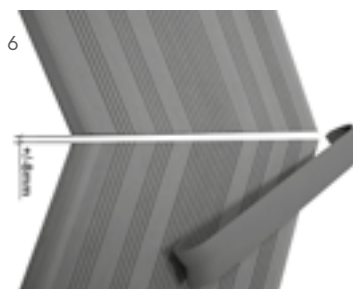
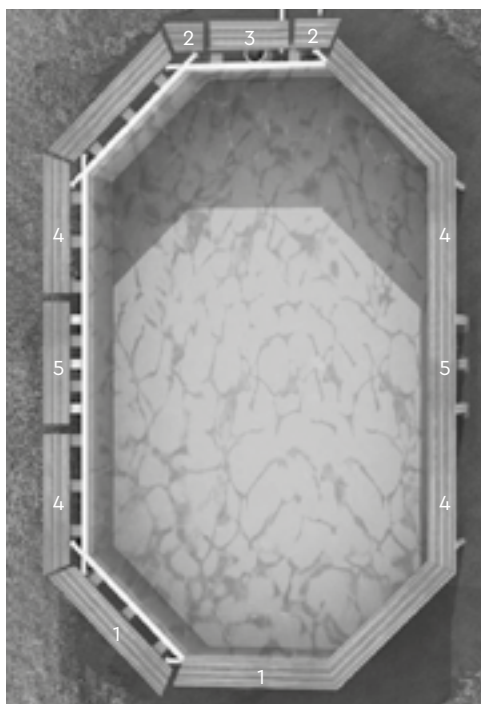

No.	Code	EAN 13	Description	Unit price
COASTAL GREY COMPOSITE COPING				
1	27921350	3566837109264	Pack, 2 copings, 1651mm, composite, grey, 440 +640	263.00
2+3	27921351	3566837109394	Pack, 3 copings, skimmer, composite grey, 440 +640	166.10
1	27922350	3566837109219	Pack, 2 copings 2001mm, composite, grey 530 +840	337.00
2+3	27922351	3566837109417	Pack, 3, skimmer copings, composite, grey, 530 +840	238.00
1	27925350	3566837109332	Pack, 2 copings 1351mm, composite, grey +540	239.00
4	27925352	3566837109257	Pack, 2 copings 1720mm, composite, grey +540	305.00
2+3	27925351	3566837109400	Pack, skimmer coping, composite, grey +540	151.70
4	27926350	3566837109271	Pack, 2 copings 2015mm, composite, grey +640 +840	340.00
5	27928350	3566837109295	Pack, 2 copings 1490mm, composite, grey +840 et 8x4	243.00
6	27921360	3566837109509	Coping/ junction pack, composite, Coastal Grey/Octo	88.80
6	27924360	3566837109196	Coping/ junction pack, composite, Coastal Grey/Octo+	115.00
HAVANA COMPOSITE COPING				
1	27921050	3566837109202	Pack, 2 copings 1651mm, composite, Havana 440 +640	292.00
2+3	27921051	3566837109387	Pack, skimmer copings, composite Havana 440 +640	159.20
1	27922050	3566837109349	Pack, 2 copings 2001mm, composite, Havana 530 +840	325.00
2+3	27922051	3566837109356	Pack, 3 skimmer copings, composite Havana 530 +840	183.90
1	27925050	3566837109325	Pack, 2 copings 1351mm, composite Havana +540	251.00
4	27925052	3566837109240	Pack, 2 copings 1720mm, composite Havana +540	312.00
2+3	27925051	3566837109363	Pack, skimmer coping, composite Havana +540	158.00
4	27926050	3566837109523	Pack, 2 copings 2015mm, composite Havana +640 +840	326.00
5	27928050	3566837109288	Pack, 2 copings 1490mm, composite Havana +840 +8x4	250.00
6	27921060	3566837109516	Coping/ junction pack composite Havana / Octo	88.90
6	27924060	3566837109455	Coping/ junction pack composite Havana/Octo+	115.30
COASTAL GREY COMPOSITE COPING/ RECTANGULAR				
1	27924350	3566837109431	Pack, 4 corner copings, composite, grey, Rect	475.00
3	27924351	3566837109479	Pack, 2 copings 990mm, composite, grey, Rect	174.80
2	27924352	3566837109318	Pack, 2 copings 1395mm, composite, grey, Rect	241.00
3	27924353	3566837109233	Pack, 2 copings 1990mm, composite, grey, Rect	313.00
3	27924354	3566837109370	Pack, 4 copings 1490mm, composite grey ,Rect	487.00
6	27924365	3566837109493	Coping/ junction pack composite grey, Rect	139.10
HAVANA COMPOSITE COPING/ RECTANGULAR				
1	27924050	3566837109424	Pack, 4 corner copings, comosite, Havana, Rect	475.00
3	27924051	3566837109486	Pack, 2 copings 990mm, composite, Havana Rect	178.20
2	27924052	3566837109301	Pack, 2 copings 1395mm, composite, Havana Rect	237.00
3	27924053	3566837109226	Pack, 2 copings 1990mm, composite, Havana Rect	323.00
3	27924054	3566837109462	Pack, 4 copings 1490mm, composite, Havana Rect	470.00
6	27924065	3566837109448	Coping/ junction pack composite Havana/Rect	139.90

ACCESS LADDER

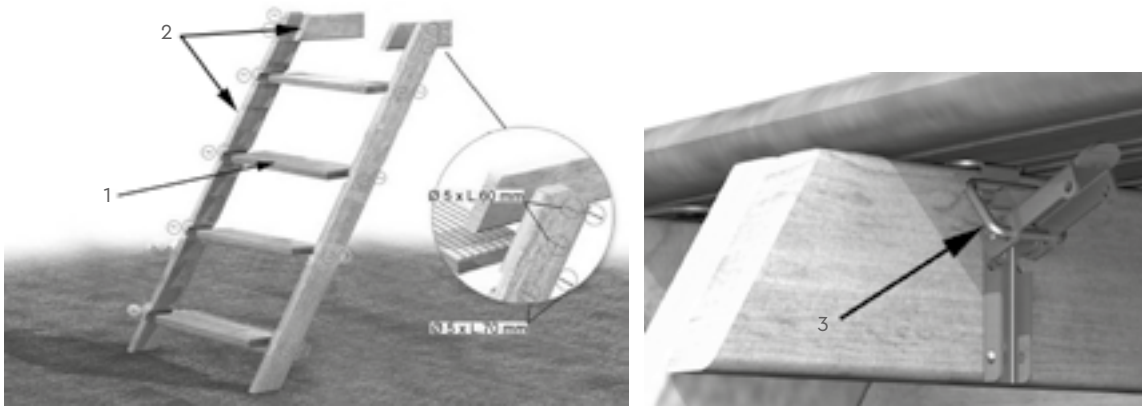

No.	Code	EAN 13	Description	Unit price
1+2+3	27911161	3566837108939	Pack, pine ladder, wooden pools octo +450, H=115	157.80
1+2+3	27911160	3566837108922	Pack, pine ladder, wooden pools Ht 120	158.10
1+2+3	27911260	3566837108946	Pack, pine ladder, wooden pools Ht 133 Octo	161.00
1+2+3	27911360	3566837108960	Pack, pine ladder, wooden pools Ht 146 Octo	172.70
1+2+3	27911860	3566837108953	Pack, pine ladder, wooden pools Ht 133 Rect	161.10
1+2+3	27911960	3566837108977	Pack, pine ladder, wooden pools Ht 146 Rect	172.80
3	27911163	3566837199296	Safety latch for pine steps, wooden pools	53.70

HUNG, LINER LOCKING TRACK

No.	Code	EAN 13	Description	Unit price
1+2	27941050	3566837108342	Pack, hung liner track with junctions, Octo	128.90
1+2	27944050	3566837108359	Wooden pool, Hung corner junctions, set of 8	174.50
1+2	27946050	3566837108366	Wooden pool, Hung straight junctions, set of 8	222.00
4	27941051	3566837209384	Pack, hung liner track with junctions, Octo+	10.30
5	27941052	3566837209346	Pack, hung liner track with junctions, Rectangle	9.00

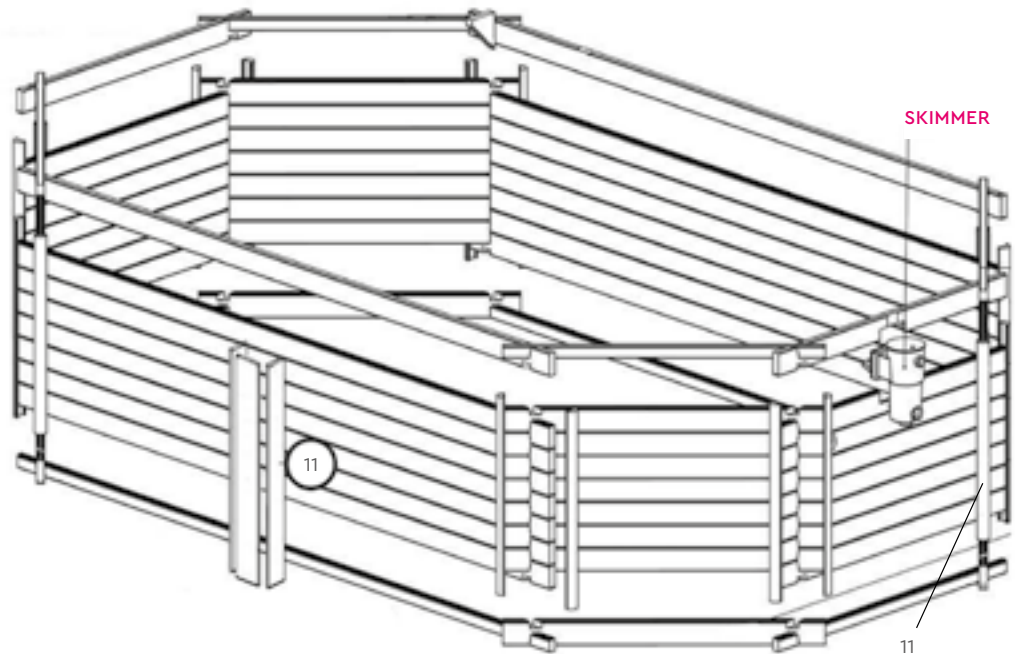
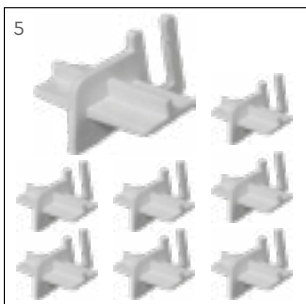
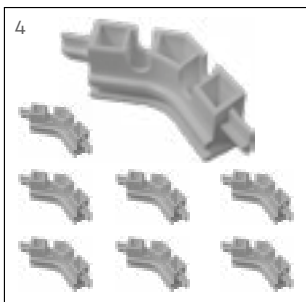

FINISHING PROFILES

N°	Code	EAN 13	Description	Unit price
11	27911062	3566837108335	Pack of 4 decorative pine profiles Ht 106	78.00
11	27911162	3566837108304	Pack of 4 decorative pine profiles Ht 120	109.50
11	27911262	3566837108311	Pack of 4 decorative pine profiles Ht 133	112.90
11	27911362	3566837108328	Pack of 4 decorative pine profiles Ht 146	117.70

WALL SLATS - OCTAGONAL POOLS

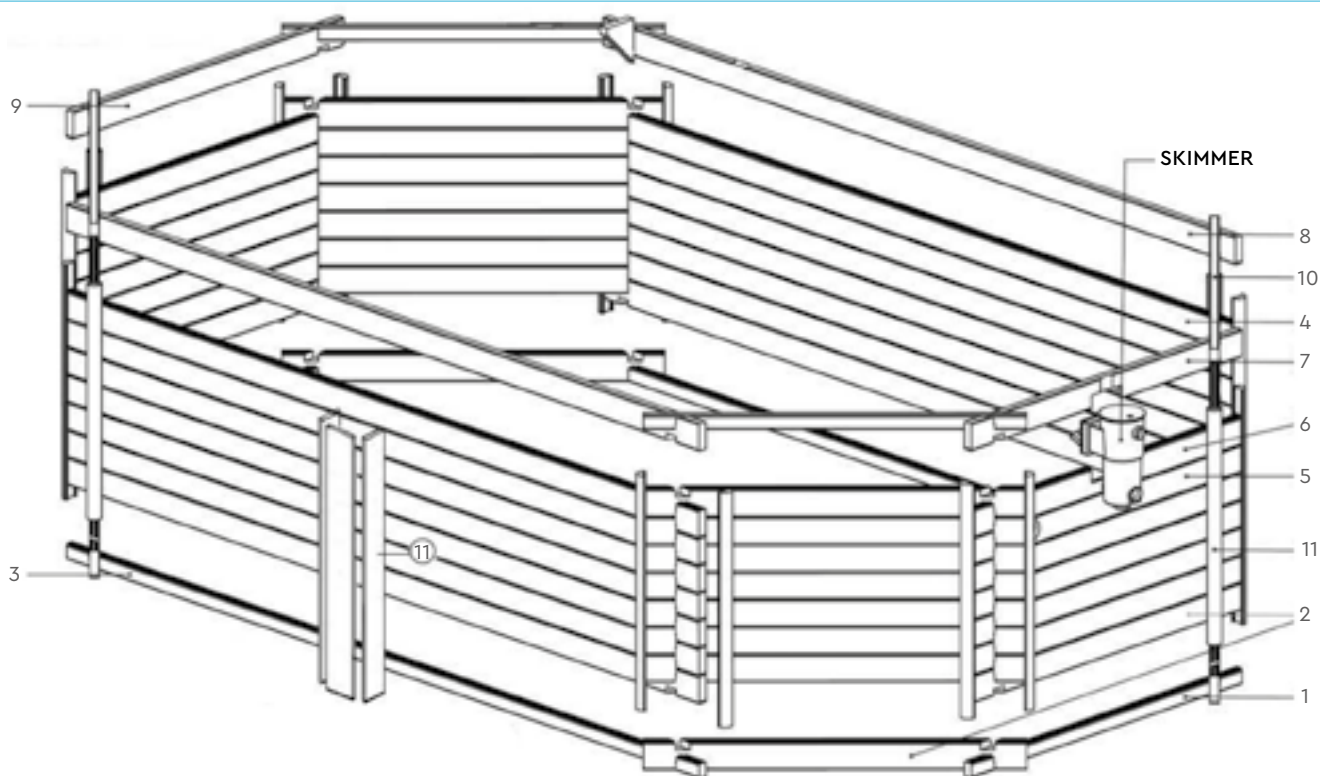

Slat dimensions: width x thickness in mm for each model

HEXA 410	OCTO 360	OCTO 440	OCTO 530	OCTO +460 UP TO 2013	OCTO +460 AFTER 2014	OCTO +510	OCTO +540	OCTO +610	OCTO +640	OCTO +840
2090 x 45	1490 x 35	1790 x 45	2140 x 45	1490 x 34 + 2990 x 34	1490 x 45 + 2990 x 45	1490 x 45 + 1790 x 45	1490 x 45 + 3590 x 45	1790 x 45 + 3890 x 45	1790 x 45 + 4180 x 45	2140 x 45 + 5680 x 45

No.	Code	EAN 13	Description	Unit price
1+9+10	27913151	3566837128227	Pack of 3 wall slats 1490mm or 1790mm M/ F	122.40
2	27911150	3566837108434	Pack of 3 wall slats 1790mm M/ F	156.50
1+9+10	27911151	3566837108441	Pack of 3 wall slats 1790mm M or F	129.00
5+6+7	27911152	3566837108458	Pack of 3 wall slats 1790mm machined	182.00
2	27912050	3566837128258	Pack of 3 wall slats 2090mm 120° M/ F	194.40
1+9+10	27912051	3566837128241	Pack of 3 wall slats 2090mm 120° M or F	157.80
5+6+7	27912052	3566837128197	Pack of 3 wall slats 2090mm 120° machined	261.00
2	27912150	3566837108465	Pack of 3 wall slats 2140mm M/ F	175.30
1+9+10	27912151	3566837108472	Pack of 3 wall slats 2140mm M or F	145.60
5+6+7	27912152	3566837108502	Pack of 3 wall slats 2140mm machined	180.50
4	27913153	3566837128210	Pack of 2 wall slats 3290mm M/ F	187.20
3+8	27913154	3566837128203	Pack of 2 wall slats 3290mm M or F	164.40
2	27914150	3566837108519	Pack of 3 wall slats 1490mmx34mm M/ F	108.30
1+9+10	27914151	3566837108526	Pack of 3 wall slats 1490mmx34mm M or F	93.50
5+6+7	27914152	3566837108533	Pack of 3 wall slats 1490mmx34mm machined	150.10
4	27914153	3566837108540	Pack of 3 wall slats 2990mmx34mm M/ F	175.20
3+8	27914154	3566837108557	Pack of 2 wall slats 2990mmx34mm M or F	123.70
2	27910150	3566837108274	Pack of 3 wall slats 1490mm M/ F	137.80
1+9+10	27910151	3566837108373	Pack of 3 wall slats 1490mm M or F	130.20
5+6+7	27910152	3566837108397	Pack of 3 wall slats 1490mm machined	160.10
4	27915150	3566837108601	Pack of 2 wall slats 3590mm M/ F	218.00
3+8	27915151	3566837108618	Pack of 2 wall slats 3590mm M or F	176.90
4	27917150	3566837108670	Pack of 2 wall slats 3890mm M/ F	251.00
3+8	27917151	3566837108687	Pack of 2 wall slats 3890mm M or F	225.00
4	27916150	3566837108625	Pack of 2 wall slats 4180mm M/ F	160.40
3+8	27916151	3566837108632	Pack of 2 wall slats 4180mm or F	193.80
4	27918250	3566837108694	Pack of 2 wall slats 5680mm M/ F	297.00
3+8	27918251	3566837108700	Pack of 2 wall slats 5680mm M or F	259.00

WALL SLATS - RECTANGULAR POOLS

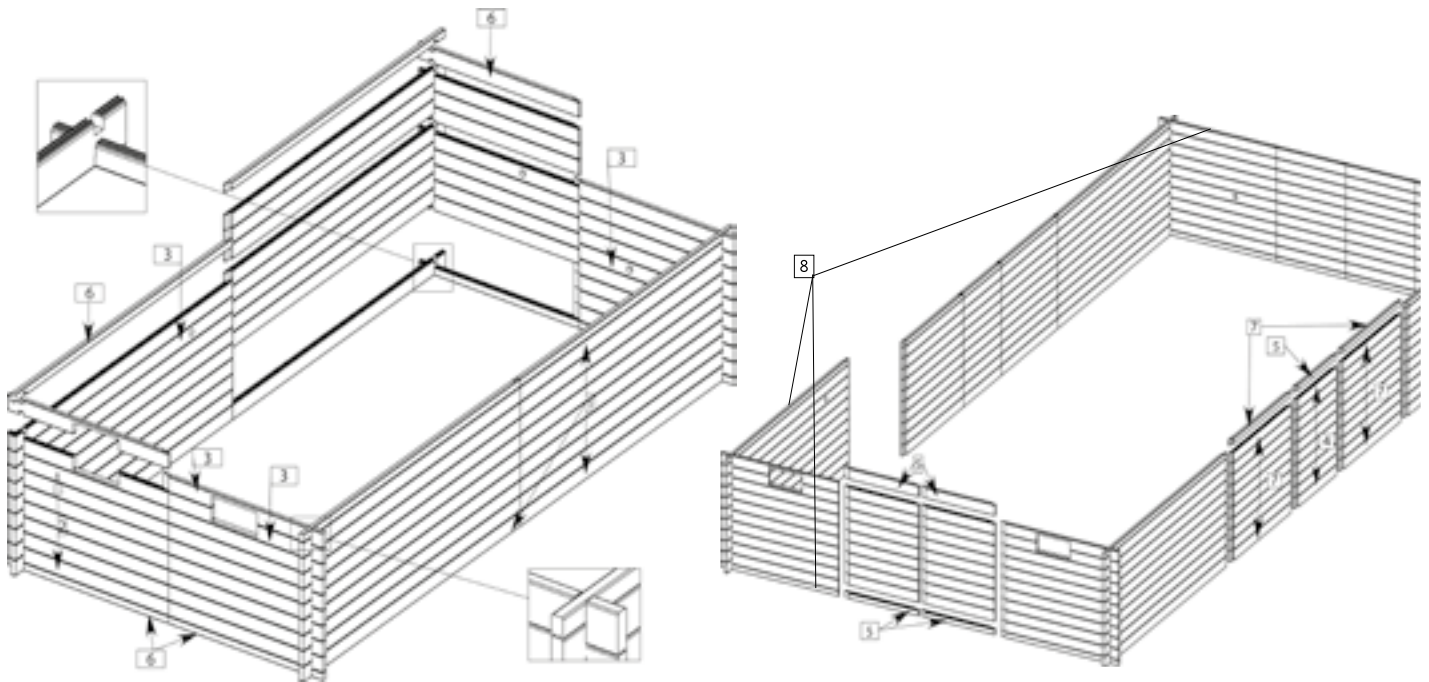

No.	Code	EAN 13	Description	Unit price
4	27916850	3566837108649	Pack of 3 wall slats 1070mm M/ F, Rect	118.10
2	27914850	3566837108564	Pack of 3 wall slats 1700mm M/ F, Rect	161.60
1	27914851	3566837108571	Pack of 3 wall slats 3200mm M/ F, Rect	233.00
3	27914852	3566837108588	Pack of 4 wall slats 1700mm machined, Rect	246.00
5	27916851	3566837108656	Pack of 3 wall slats 1070mm M/ F	105.70
6	27914853	3566837108595	Pack of 3 wall slats 1700mm and 3200mm M/ F	203.00
8	27912853	3566837128234	Pack of 3 wall slats 1700mm 1 male, 1/2 F and F	135.50
7	27916852	3566837108663	Pack of 3 wall slats 1570mm M/ F and F	139.10

FINISHING STRIP FOR CRADLES AND SUPPORTING BRACES

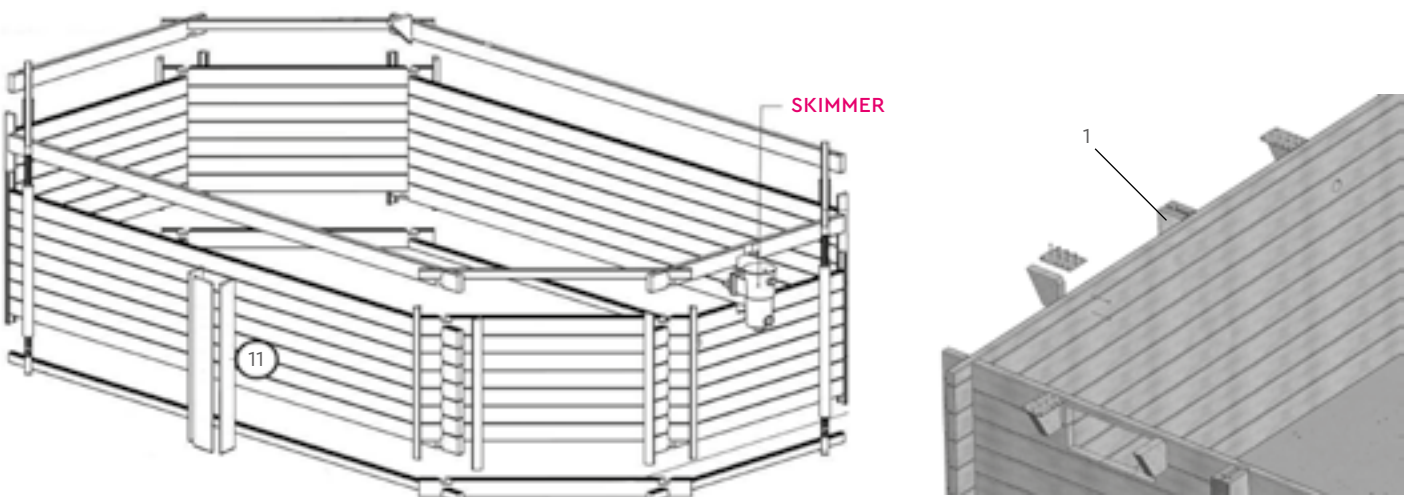

No.	Code	EAN 13	Description	Unit price
11	27914155	3566837109097	Pack of 4 cradle decorative profiles Ht115	135.20
11	27915255	3566837109103	Pack of 4 cradle decorative profiles Ht120	142.20
11	27915355	3566837109110	Pack of 4 cradle decorative profiles Ht133	149.80
11	27916355	3566837109127	Pack of 4 cradle decorative profiles Ht146	158.60
1	27914355	3566837109134	Pack of 4 supporting brace decorative profiles H120	134.60
1	27916855	3566837109141	Pack of 4 supporting brace decorative profiles H133	154.70
1	27916955	3566837109158	Pack of 4 supporting brace decorative profiles H146	140.70

SPA SPARE PARTS

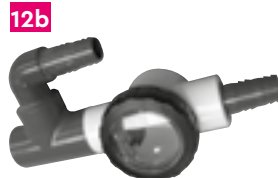
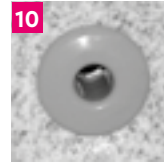
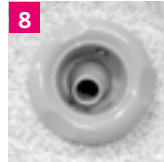

SPA SPARE PARTS

No.	Code	EAN 13	Description	Unit price
1	31090056	3566835487975	SP800 digital touch control panel with adhesive	371.00
2	31490456	3566835487920	SP1200 digital touch control panel with adhesive	371.00
3	31998050	3566837089511	SP601 digital touch control panel with adhesive	219.00
4	31090974	3566837039929	SP601/SP800/SP1200 temperature sensor	91.70
5	31090972	3566837039936	SF-D74 LED underwater light assembly	128.30
6	31090966	3566837029852	Dual rotating jet face plate, SF-D95, grey, 4	139.10
7	31090960	3566837030032	Multi-directional jet face plate, SF-D95 grey, 4	66.60
8	31090968	3566837029869	Multi-directional jet face plate, SF-D70 grey, 4	24.60
9	31090964	3566837029838	Rotating jet face plate, SF-D95, grey, 5	150.40
10	31090962	3566837029845	Mini-jet face plate, SF-D38, grey, 2	4.97
11	31090971	3566837047092	SF-D95 diverting valve, with unions	97.70
12a	31090961	3566837047160	Check valve with union	95.10
12b	31090976	3566837209391	Union check valve, 2 massage station spa	90.40
13	31090963	3566837039561	Aromatherapy diffuser assembly	44.50
14	31090965	3566837047108	Spa ozonator	353.00
15	31090967	3566837047030	Ozonator connections	105.90
16	31098068	3566837089542	Air jet nozzle, D38, 2	18.60
17	31090970	3566837029876	Main drain grate SF-100AV grey, set of 2	15.80
18	31090107	3566835520672	Face trim for 2 cartridge filtering skimmer	216.00
19	31090969	3566837047047	Drain valve with adaptator	47.20
20	31098065	3566837089573	SF-100AV main drain body	23.50
21	31098067	3566837089559	Jet body and gasket, D95, 4	41.80
22	31098066	3566837089566	Jet body and gasket, D70, 4	65.50
23	31098051	3566837064396	Spa head rest, grey, 2 attachment points, unit	32.60
24	31093090	3566837059088	Grey head rest, 2 attach. points/5 place Eco spa	25.30
25	31698050	3566837089528	Adjustable Spa head rest, grey, 2	42.70
26	31090975	3566837047153	Spa head rest, 1 attachment point, grey, set of 2	92.50

PUMP



No	Code	EAN 13	Description	Unit price
1	31098063	3566837089597	Nipple threaded 2"1/4, female solvent 1.5", 2	10.20
2	31098060	3566837089627	Hose tail 1"x3/4/31	3.97
3	31098059	3566837089634	Slit valve, 60 (2")	26.50
4	31098058	3566837089641	Torro clamp 25-40/12 W4 A2, 5	9.30
5	31098057	3566837089665	Cobra clamp 26/8 W4 A2, 5	3.83
6	31098056	3566837089658	Cobra clamp 15/8 W4 A2, 10	5.30
7	31098061	3566837089610	Hose tail 2"x53/50	6.30
8	31098062	3566837089603	Air outlet plug D6-M, 5	7.00
9	31298050	3566837200732	SP800/1200 spa pack single speed pump	638.00
10	31298051	3566837200725	SP800/1200 spa pack two speed pump	740.00
11	31298052	3566837200718	SP800/1200 spa pack variable speed blower	300.00
12	31190254	3566835519676	SP800/1200 massage pump fan cowl#	202.00
13	31090364	3566835519393	SP800/1200 spa pump impeller	39.60
14	31090361	3566835519362	SP800/1200 pump mechanical seal	47.00
15	31090362	3566835519379	SP800/1200 spa pump seal plate	31.80
16	31090365	3566835519409	SP800/1200 spa pump volute o-ring	8.50
17	31090363	3566835519386	SP800/1200 spa pump volute	39.40
18	31090369	3566835519652	Two-speed pump low speed capacitor, 16mF	97.90
19	31090973	3566837047085	Air flow controller, set of 2	35.50
20	31098064	3566837089580	SP800-1200 pump, nut collar, seal RU 2" I/O	9.60
21	31098055	3566837089672	SP800 control plate with unions	583.00
22	31498055	3566837089535	SP1200 control plate with unions	697.00
-	31993067	3566837142452	SP 601 spa pack with unions	575.00
-	2499521	3566835519690	Compact 2000 sensor#	130.10
-	31098052	3566837102777	Heater water detection sensor SP601/800/1200	40.60
-	31490458	3566835487913	Heating element, 3.5 Kw for SP1200+tube	343.00
-	31090058	3566835487968	Heating element, 2 Kw for SP601-SP800+tube	292.00
-	31090051	3566835487999	SP800/SP1200 inlet/outlet union 2" #	21.80
-	31098069	3566837104856	Spa cover clips, set of 4*	21.20

AIR CIRCUIT

INFOS

The air manifolds and water manifolds are delivered with 1 or more caps and clamps.

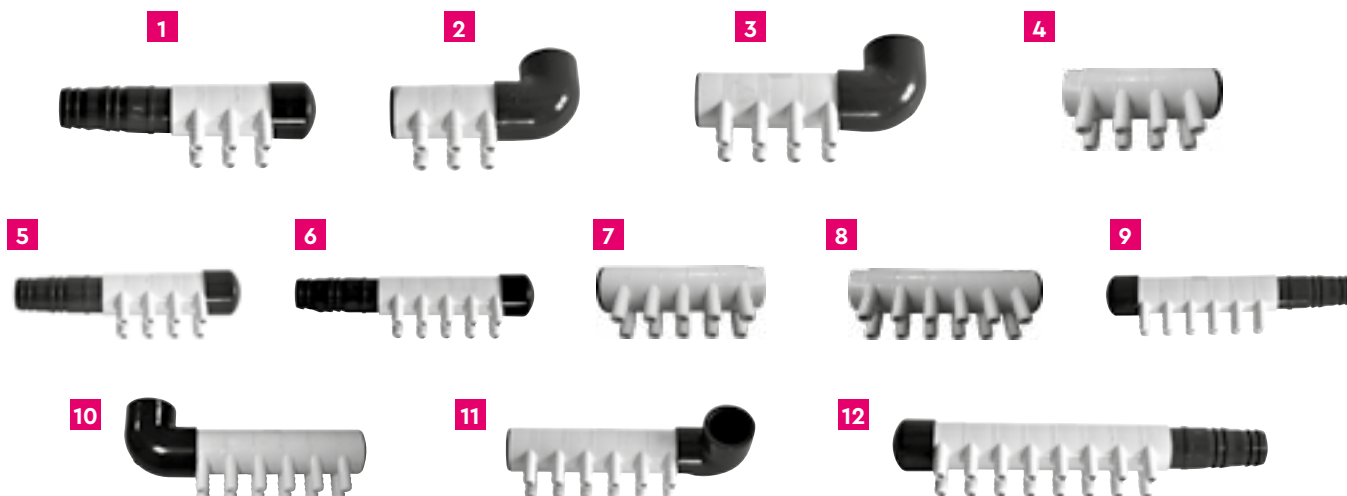

No.	Code	EAN 13	Description	Unit price
1	31490473	3566835501893	Air manifold 6 holes barbed, 1", straight	38.90
2	31290271	3566835501848	Air manifold 6 holes female 90°, 1"	39.90
3	31090272	3566835501770	Air manifold female 90°, 1"	40.40
4	31190272	3566835501800	Air manifold, 8 holes male solvent, 1"	40.20
5	31190273	3566835501817	Air manifold, 8 holes, barbed, 1" straight	40.90
6	31090271	3566835501763	Air manifold, 12 holes, male, solvent, 1"	45.20
7	31190274	3566835501824	Air manifold, 10 holes, male, solvent, 1"	43.20
8	31490471	3566835501879	Air manifold, 12 holes, male, solvent, 1"	45.80
9	31490470	3566835501855	Air manifold 10 holes, barbed, 1" straight	47.00
10	31190271	3566835501794	Air manifold 12 holes female 90° solvent, 1"	47.50
11	31090270	3566835501756	Air manifold, 12 holes, fem 90°, 1" - 1/4 turn	47.50
12	31190270	3566835501787	Air manifold, 16 holes, barbed, 1" straight	54.10

WATER CIRCUIT

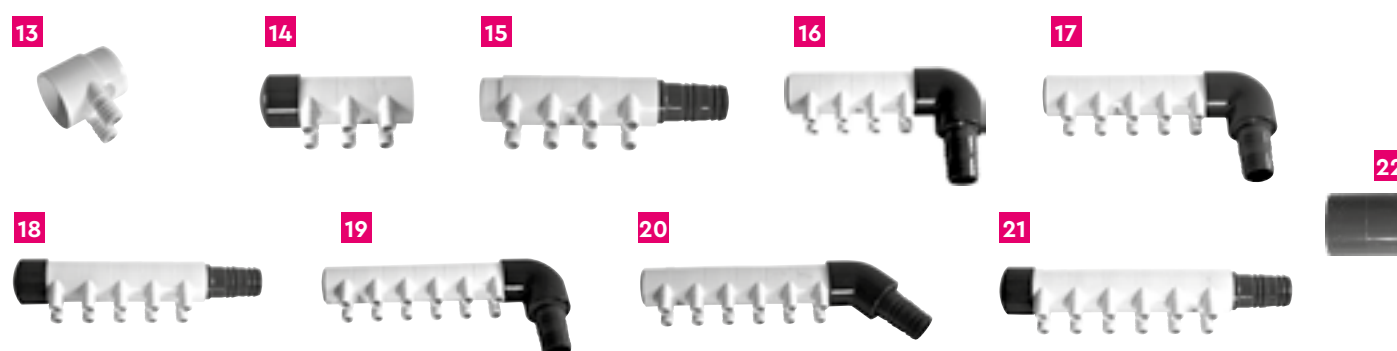

No.	Code	EAN 13	Description	Unit price
13	31090084	3566835484349	Water manifold, 2 holes, MF, 2" #	13.20
14	31290282	3566835501954	Water manifold 6 holes, 2"	49.20
15	31290281	3566835501947	Water manifold 8 holes 2" straight/male, 2"	54.50
16	31090281	3566835501916	Water manifold 8 holes barbed 2", 90°	63.50
17	31190280	3566835501923	Water manifold 10 holes barbed 2" 90°	68.50
18	31290280	3566835501930	Water manifold 10 holes barbed 2" straight	63.20
19	31090280	3566835501909	Water manifold 12 holes barbed 2", 90°	74.10
20	31290283	3566835501961	Water manifold 12 holes barbed 2" 45°	74.20
21	31490480	3566835501978	Water manifold 12 holes barbed 2" straight	69.00
22	31098070	3566837209339	Sleeve, F/F, solvent, 1"	4.64





09

BWT myPOOL Appendices

LINERS - SURFACE AREA CALCULATIONS	182
CUSTOM ORDERS	183
ORDER FORM	184
GENERAL SALES CONDITIONS	188

LINER WITH DIVING PIT

Wedge base		
Pool base surface area	Pool wall surface area	Total surface area
$L \times W \times 1.30 = S1$	$(L + W) \times 2 \times H = S2$	$S1 + S2 = S$

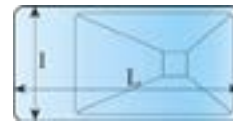

Sloped base		
Pool base surface area	Pool wall surface area	Total surface area
$L \times W = S1$	$(L + l) \times 2 \times \frac{(H + P)}{2} = S2$	$S1 + S2 = S$



1.30 is an empirical coefficient needed to calculate the total net surface area of the pool base.

LINER WITH A CURVED BASE

If the difference between the measurements H1 and H is less than 40cm, the coefficient 1.30 may be left out of the pool base surface area calculation.

Standard shaped base		
Pool base surface area	Pool wall surface area	Total surface area
$L \times W \times 1.30 = S1$	$(L + W) \times 2 \times H = S2$	$S1 + S2 = S$

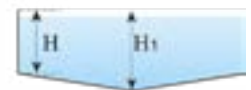

Round, flat bottom		
Pool base surface area	Pool wall surface area	Total surface area
$D \times D \times 1.30 = S1$	$3.14 \times D \times H = S2$	$S1 + S2 = S$



1.30 is an empirical coefficient needed to calculate the total net surface area of the pool base.

LINER WITH STANDARD SHAPED BASE

Sloped base		
Pool base surface area	Pool wall surface area	Total surface area
$L \times W = S1$	$(L + W) \times 2 \times H = S2$	$S1 + S2 = S$

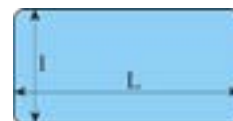

Rond à fond plat		
Pool base surface area	Pool wall surface area	Total surface area
$D \times D = S1$	$3.14 \times D \times H = S2$	$S1 + S2 = S$

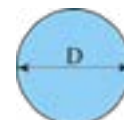

INFOS LINER WITH STEPS,
PLEASE CONTACT US.

LINERS, BAR COVERS, SUMMER COVERS AND WINTER COVERS

Please fill in the pool's interior and overall dimensions including the coping.

POOL DIMENSIONS

Interior dimensions: cm

Overall dimensions, coping included: cm

A large grid area for drawing the pool layout, consisting of a 30x30 grid of small squares. The grid is intended for the user to draw the pool's shape and dimensions.



In as far as all elements constituting the standard were ordered from Procopi.

P-HS E AUTOMATIC COVER

INSTALLER
 Client Ref:
 Corporate name:
 Contact:
 Tel no:

DELIVERY ADDRESS
 Name:
 Address:

 Post code:
 City:

TRANSPORT
 Large truck:
 Small truck:
 Lorry with forklift truck:
 Wooden crate

P-HS E

SLAT COVER White Beige Grey

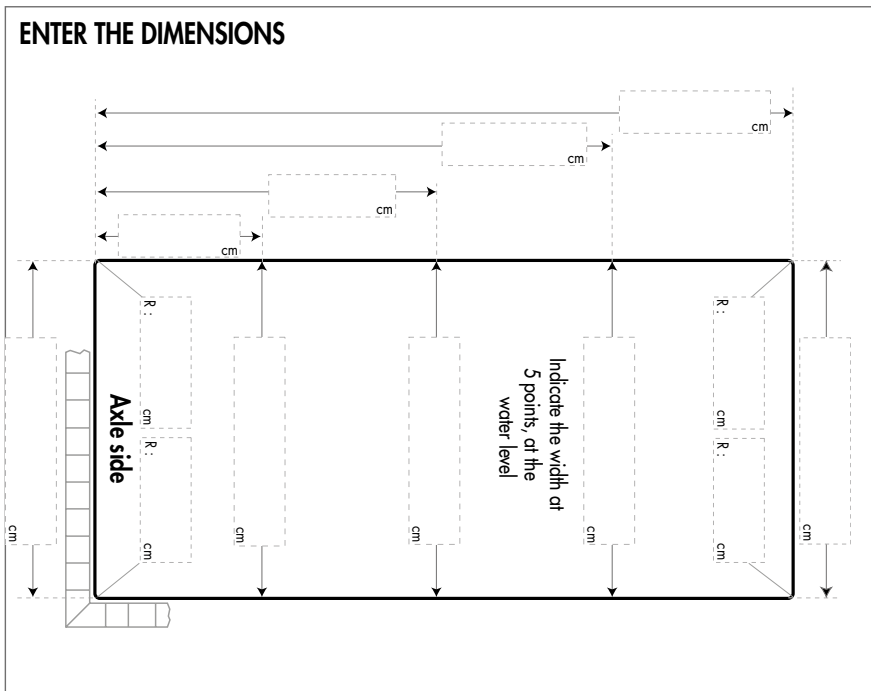

DIMENSIONS:
 With waterproofing W/o waterproofing
 Type of waterproofing:
 (mandatory if you ticked "w/o waterproofing), and
 provide the value of a single layer)
 Liner/ Membrane with felt
 Thickness:cm
 1.5 mm membrane or liner without underlay
 Tiles
 Thickness:cm
 Ceramic tile band
 Thickness: cm

IMPORTANT :
 - If the skimmers are located along the length, indicate on the diagram their position and the amount that the skimmer flange protrudes into pool.
 - If the skimmers are located along the width, indicate their position and the dimensions of the skimmer mouth on the diagram.

The French standard NF P 90-308 prohibits uncovered gaps of more than 250mm. If it is observed that a stepped finish would result in a gap of more than 250 mm between the cover and the pool wall, the section concerned will be automatically given a mastic finish.

Safety fastener (the number of fasteners will be automatically calculated based on the cover dimensions)
Wall-mounted fastener
 Light blue Dark blue White Green Beige Grey

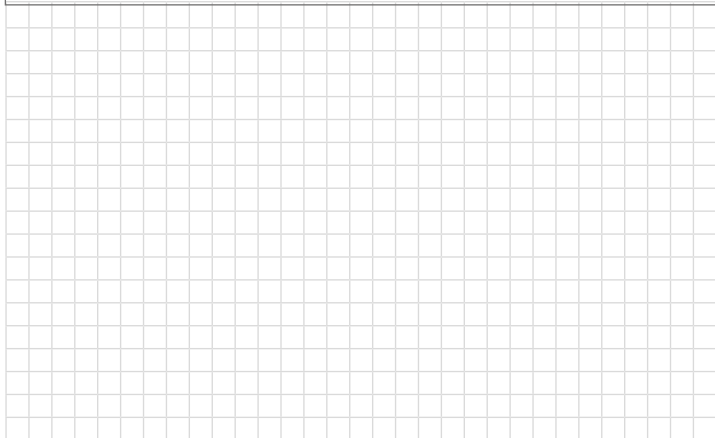

DATE AND SIGNATURE:



Wherever you are *IN WHATEVER SECTOR* you'll find BWT's

WATER TREATMENT EXPERTISE

MAGNESIUM MINERALIZED DRINKING WATER

Magnesium-mineralized water offers a genuine taste experience, while providing the perfect supplement to your recommended daily magnesium requirement. It also has an almost neutral pH value and contains less calcium and taste-inhibiting substances. Not only does this bring out the full flavour of coffee and tea, but it also prevents limescale deposits from forming in your kitchen appliances. BWT's unique, patented technology enriches tap water with the precious, vital mineral magnesium in the Magnesium Mineralizer and, at the touch of a button, in the AQA Drink Pro 20 drinking water dispenser.

SILKY-SOFT BWT PEARL WATER FOR SHOWERS AND POOLS

Silky-soft water is a true beauty elixir. The low calcium content in the water leaves fewer residues on your skin and hair, and care products are therefore more easily absorbed. Silky-soft BWT Pearl Water also contributes to shinier bathrooms and kitchens and your laundry feels cuddly-soft. Here too, soft water means less calcium in the water and fewer limescale residues on fixtures, tiles, glassware, cutlery and your weekly wash. Pearl water for pools provides silky-soft, calcium-free and PH-neutral swimming pool water – perfect for cool, unadulterated pleasure.

BWT WFI – WATER FOR INJECTION WATER FOR PHARMA & BIOTECH

We are not always aware that we come into contact with BWT Purified Water every day; for example, it is present in cosmetics, medicines and other pharmaceutical products. The purest water is WFI, which is used for infusions. Purified water is an essential ingredient in numerous products where safety and purity are top priorities. This is why manufacturers rely on purified water from BWT's production systems, ultimately improving our daily lives and enhancing our quality of life.

MAGNESIUM MINERALIZED WATER



BWT AQA DRINK PRO 20

BWT MAGNESIUM MINERALIZER



BWT WFI – WATER FOR INJECTION



SILKY-SOFT BWT PEARL WATER



BWT PEARL WATER GENERATOR



BWT PERLA



BWT OSMOTRON® WFI

Article 1 - Warning

In order to improve the quality of its products, Procopi hereby reserves the right to modify the technical data of items it manufactures at any time and without advance notice.

The sketches, photos, texts and illustrations included in the catalogues, Aquasoft DVD, ProcoShop and the Procopi internet sites or communicated by any other means by Procopi, are provided for information purposes only and may under no circumstances be considered contractually binding. All copying or representation of the sketches, photos, texts or illustrations published in the catalogues, Aquasoft DVD, ProcoShop or on the Procopi internet sites, even partial and irrespective of the means, shall be construed as illegal and fraudulent unless authorised explicitly by Procopi.

Article 2 - General provisions

Clients and Procopi hereby mutually recognise each other's status as professionals dealing in the products, materials and services sold.

The general sales terms and conditions hereto shall only govern commercial dealings between Procopi and its dealers, hereinafter referred to as the client or clients. They shall under no circumstances govern contractual dealings between Procopi dealers and consumers.

Orders placed with Procopi and contracts dealt with by the latter shall be subject to the general sales terms and conditions set out hereinafter that shall cancel and supersede all clauses contained in documents issued by clients and co-contractors. Consequently, no other term or condition shall nullify the effect of the general terms and conditions hereto unless Procopi explicitly agrees to said in writing.

Article 3 - Acceptance of orders

No person shall claim or benefit from any sort of tacit understanding with Procopi. Only orders accepted by Procopi are valid.

As regards orders placed on-line via the Procopi internet site (ProcoShop), acceptance of the order and conclusion of the sale are construed as having taken place upon receipt, by the client, of the electronic acknowledgement of receipt.

Article 4 - Sales terms and conditions

The prices indicated in Procopi's catalogues, price lists, the Aquasoft DVD and Procopi internet sites, or any other means communicated by Procopi, are quoted in Euro ex VAT and any other tax. Invoices are payable in Euro and, unless indicated otherwise in the specific terms and conditions, Procopi ex-warehouse. Said prices are susceptible to modification without prior notification at any time to reflect the evolution of the national and international economic and monetary climate. Any sales terms and conditions granted to clients by Procopi's Sales Reps and/or Regional Managers must be confirmed in writing.

In the event of a discrepancy or a dispute arising between Procopi and one of its clients concerning the application of these sales terms and conditions, only offers confirmed in writing will be taken into consideration.

Article 5 - Payment

Invoices are payable in full, without discount, at the address indicated on the invoice.

As regards export sales, goods are payable prior to shipment or by confirmed irrevocable letter of credit drawn on a leading French bank.

However, a discount of 2% shall be applied for settlement by cheque enclosed with the order. A discount may also be applied, by virtue of specific terms and conditions, for advance payment. The percentage represented by this discount will be indicated on the invoice. In the event that a discount is allowed, only VAT on the price actually paid will give rise to a discount.

Upon opening a credit line reserved for sustained commercial dealings, invoices shall be payable, without any discount, by Electronic Bill of Exchange payable without prior acceptance, at 30 days end of month as of the date upon which the merchandise was shipped.

Electronic Bills of Exchange forwarded for acceptance should be returned within one week of their receipt by the client.

Any delay in payment will, in full right, entail invoicing of late payment penalties to the client as of the day following the date of payment indicated on the invoice and up until the date on which payment of said is made. Late payment charges shall be calculated based on the entire sum outstanding at the rate of 1% per month, or part of month, late, any month begun being due.

Furthermore, any discount previously agreed will be cancelled.

Credit granted to a client shall be construed as a payment facility and may be revoked at any time. Any significant alteration of the client's economic or financial situation may entail the revision of payment conditions, even subsequent to partial execution of orders.

Refusal to accept Electronic Bills of Exchange or failure to pay a trade bill or negotiable instrument upon its due date shall render the whole debt payable immediately and in full without any prior notice and shall entail the suspension of deliveries. Failure to settle an accepted trade bill or negotiable instrument upon its due date will entail the suspension of all terms of credit (delivery upon payment).

In the event of late payment, a fixed fee of €40 exVAT will be charged to cover collection costs.

Article 6 - Delivery lead times and charges

Article 6.1 - Charges

6.1.1 - General orders

The delivery charges indicated in the version of the Procopi catalogue that is currently in effect will be invoiced for every order worth less than € 380 ex VAT (or €110 ex VAT for spare parts orders).

Orders worth more than €380 ex VAT (or € 110 net ex VAT for spares) delivered in one shipment within "mainland France" (metropolitan France, excluding Corsica and the islands not linked by road to the mainland) to the Client's premises or to a Procopi agency (for collection by the client) shall be delivered free of charge.

For those orders constituting the subject of this article 6.1.1, should the client wish the delivery to be made within "mainland France" to an address other than those stipulated in the previous paragraph (Procopi agency or Client premises):

- The client hereby undertakes to be present at the agreed location at the time of delivery to receive the merchandise;
- A fixed charge of € 22.00 ex VAT per shipment will be invoiced for modifying the delivery address;

In the event of a COD delivery, collection charges stipulated in the catalogue currently in effect will be payable by the client.

Express deliveries are also available. However, transport charges will be payable by the addressee.

6.1.2 Exceptions

As an exception to the provisions set out in article 6.1.1 hereinafter:

- Delivery of sand, spas, Wooden pools, Paradis Bleu pools, automatic covers

and soft covers will be invoiced according to the Procopi transport conditions in effect, it being stipulated that the Client hereby undertakes to be present at the agreed location upon delivery to receive the merchandise.

- Goods considered dangerous by carriers are, due to this fact, subject to specific transport costs.

6.1.3 - Ancillary costs

The costs incurred by packaging or customs formalities; inspections or consular visas specific to dangerous goods (liquid PVC, glue, water treatment products, etc.) will be invoiced to the client. The cost of visas for orders worth more than € 15,000 ex VAT, excluding freight charges and delivered in one shipment and to one address, will be paid by Procopi.

Article 6.2 - Delivery lead times

Delivery leadtimes are indicated for information purposes, delays shall not entail the cancellation of the order.

However, in the event of a delivery delay, the client may formally request by registered letter that Procopi deliver the goods within a time period of 15 days as of the date on which said registered letter is received. Upon expiry of this deadline, the client may cancel the order in question.

Article 7 - Transfer of ownership

In accordance with the legal provisions in effect, transfer of ownership of the goods delivered shall take place at the time at which the price of said goods is paid in full. However, risks shall be transferred to the client as of such time as the goods are made available to the client, to the client's representative or to the carrier.

Article 8 - Acceptance and complaints

Goods travel at the risk and responsibility of the addressee.

In the event of any dispute or discrepancy concerning the delivery by the carrier the addressee must:

- Note the dispute or discrepancy on the delivery stub: missing package, damaged package, damp package, etc. and under no circumstances: "reserved subject to opening" which is too vague and will be rejected by carriers,
- Notes such as "package broken", "package wet" etc are not acceptable. Under such circumstances, open the package, identify the exact nature of the damage to the article and record this on the delivery stub,
- Send confirmation of the reservations indicated on the stub to the carrier (not Procopi) by registered mail with a copy to Procopi, within three working days as of delivery,
- Forward the original of the delivery stub to Procopi as quickly as possible, along with a copy of the registered letter sent to the carrier.

CAUTION: A complaint will not be accepted unless these three points have been respected to the letter.

Article 9 - Returns

Clients may return spare parts within a 30 day period, this does not apply to goods made to order, (BWT covers, liners, etc.) goods that are discontinued (#) or good available only on order (*).

In the event of a return, said return must:

- be previously agreed to by Procopi, said agreement to be embodied by the communication of a goods return number, - concern goods featured in the Procopi's catalogue in effect at the time that the goods are returned,
- be accompanied by either the invoice or delivery slip as well as a statement of the grounds for the return,
- be sent post paid,
- be in its original packaging and accompanied by the original documents.

CAUTION: Failure to abide by the aforementioned conditions shall entail either refusal of the goods returned or acceptance of the goods returned with a 25% reduction of the price invoiced.

Article 10 - Contractual guarantees

All items manufactured or distributed by Procopi are covered by a 2 year guarantee, under the terms and conditions set out in the guarantee enclosed at delivery. These guarantees enter into effect on the client invoice date.

Guarantees are effective subject to the condition that equipment items are installed, maintained or repaired by qualified professionals who abide by the rules of the art laid out in the operating and installation instructions and other standard documents (DTP "Directives Techniques Piscines" (pool technical directives), AFNOR (French standards association) standards, etc.).

The repair under guarantee of any item manufactured or distributed by Procopi will in no way alter the date on which the contractual guarantee covering said item, and calculated based on its date of invoice, expires.

Similarly, the replacement under guarantee of any item manufactured or distributed by Procopi will in no way alter the expiry date of the contractual guarantee covering the replacement item and that is calculated based on the initial invoice date of the latter.

Unless otherwise stipulated, coverage shall be limited to the replacement of the part or equipment item acknowledged as defective in our workshops, labour included. Freight costs, call out charges and other damages are not included in the scope of the guarantee. In the event of an intervention by the client, coverage shall be limited to the supply of the part or equipment item acknowledged as defective. Freight costs, call out charges and other damages are not included in the scope of the guarantee.

Repairs carried out by Procopi's after sales services outside the scope of any guarantee will themselves be guaranteed 6 months as of the date on which the repair was invoiced. Consumable items (chemicals, maintenance accessories, etc.) and wear parts (seals and gaskets, baskets, belts, bulbs, etc.) are not covered by any guarantee. Neither the effects of normal wear and tear (cartridges, incandescent bulbs, maintenance accessories, above ground pool liners and covers) nor the repercussions of inappropriate usage are covered by any guarantee.

The following are specifically excluded from any guarantee; damage not attributable to the pool or pool equipment, such as that occasioned by impact, fire, frost, infestation by termites or any other parasite, lightning, flooding or any other natural catastrophe.

Should it prove impossible to ascertain the exact cause of the malfunction hindering correct operation of an equipment item, and at the client's explicit request, Procopi may send one of its technicians to perform troubleshooting. In all cases an intervention slip, duly accepted by the client, setting out the intervention in detail will be drafted for such interventions.

Following said troubleshooting, and depending on whether or not the cause of the malfunction falls within the realm of Procopi's responsibility or not, Procopi may or may not invoice the client labour costs and call out charges as well as any spare parts required.

NOTA BENE: Guarantee claims from professional clients will only be accepted after diagnostics carried out on the installation site or in the work shop a

technician accredited by Procopi. Information communicated by the professional client in good faith, by the Hot-line or by any other Procopi employee prior to the aforementioned diagnostics are under no circumstances opposable by the latter.

CAUTION:

The presence of salt in the pool water is considered to increase the risk of corrosion of metallic equipment items such as the ladder, heater, heat exchanger, condenser, automated cover axle, etc.

The Redox value varies depending on the type of oxidising agent used (stabilised or non-stabilised), the pH and the concentration of Isocyanuric acid. In order to avoid fading of pigments in the waterproofing membrane and corrosion of metals and alloys, the Redox potential must be kept under 750 mV at all times. Otherwise, resulting corrosion and/ or fading will under no circumstances be covered by the guarantee.

The quality of the water in the pool must at all times comply with the public water supply, notably in terms of its metallic salt content (Copper, iron, manganese, etc.), its mineral salts content (Calcium, magnesium, etc.), and its pH, etc.

Bad quality water in the pool can initiate or facilitate the corrosion of metallic equipment items and premature ageing of waterproofing. Before filling the pool with water from another source, the client must ensure that the physico-chemical characteristics of said alternative pool water supply comply with those of the public water supply.

Procopi hereby reserves the right to fully or partially suspend the guarantee in the event that non-compliant water is used to fill the pool.

Article 11 - Liability and insurance

The client and Procopi hereby mutually recognise each other's status as professionals dealing in the products sold.

The client hereby acknowledges that Procopi sells equipment subsequently incorporated into an operational assembly by the client.

The client, in its capacity as a swimming pool professional, has sole responsibility regarding the selection of the product, the product's integration into the assembly and its correct usage according to the rules of the art, regulations in effect and the results the client is endeavouring to achieve.

Procopi shall under no circumstances be held to any obligation regarding the final result. The client must advise Procopi of any defects attributable to the product immediately, providing evidence in support of the latter.

The client must provide Procopi every opportunity to investigate alleged defects and remedy said. Procopi will be released from its obligations in the event of Force Majeure.

The following shall be understood to constitute Force Majeure and as such to suspend or nullify Procopi's obligations without any recourse by the client: accidents effecting production and storage of the products, the total or partial interruption of procurement, a fault committed by the carrier, fire, flood, machine breakdown, total or partial strike, administrative decisions, acts attributable to third parties, war and any other act beyond Procopi's control likely to delay or prevent performance of contractual commitments or render said financially unviable.

Procopi has taken out policies insuring it for the usual risks associated with its activities and to the level usual for this profession. Valid certificates and guarantee tables are available to its clients.

It is hereby explicitly agreed that the client will renounce all recourse of any kind above the ceiling of the guarantee taken out by Procopi. This constitutes a substantive clause of the agreement hereto.

Article 12 - Spare parts

In accordance with the provisions set out in articles L 111-3 and R 111-3 of the French Consumer code, Procopi hereby guarantees the supply of spare parts required to maintain the equipment items listed in its professional catalogues according to one of the following terms:

- For a time period of 2 years commencing on the date on which the product was withdrawn from sale, bearing in mind that the date of withdrawal from sales of a Product manufactured and/ or supplied by Procopi shall be the 31st of December of the year prior to that in which the aforementioned Product was withdrawn from Procopi's catalogues (BWT Pool, BWT Aquaservice and BWT MyPool).
- At the end of the contractual guarantee accompanying the sale of the product, said guarantee entering into effect on the date of invoice of the aforementioned product to Procopi's Client's end user.

Article 13 - Jurisdiction of competence

Any discrepancy or dispute arising from the construction hereto shall be brought before the Commercial Courts of RENNES (France) who shall have sole jurisdiction in such matters.

Neither the client's purchasing terms and conditions, if any, nor the location of execution of the order or the contract, nor, more generally, any concession regarding the general sales terms and conditions shall have any effect on this clause attributing jurisdiction of competence, even in the event of a guarantee claim or in the case of multiple defendants.

Last updated: 7th of November 2018

The Made in France spa for everyone !





**BWT POOL Division
PROCOPI S.A.S.**

Export customer service

Les Landes d'Apigné – B.P. 45328

35653 LE RHEU Cedex – FRANCE

☎ +33 (0)2 99 14 00 88 📠 +33 (0)2 99 14 75 01

✉ export@procopi.com

procopi.com

PLC with a share capital of € 7,000,000 | Register of commerce Rennes B 333 263 846 000 37